**User's
Manual**

DXAdvancedR4!

**Model DX1002/DX1004/DX1006/DX1012/
DX1002N/DX1004N/DX1006N/DX1012N
Daqstation DX1000/DX1000N**

vigilantplant.®

Thank you for purchasing the Daqstation DX1000 (hereafter referred to as “DX”). This User’s Manual explains how to use the DX. To ensure correct use, please read this manual thoroughly before operation.

The following manuals are provided for the DX:

- **Paper Manual**

Manual Title	Manual No.	Description
DX1000 Operation Guide	IM 04L41B01-02E	Explains the basic operations of the DX. It is also provided in the CD-ROM.
Control of Pollution Caused by the Product	IM 04L41B01-91C	Gives a description of pollution control.

- **Electronic Manuals Provided on the Accompanying CD-ROM**

Manual Title	Manual No.	Description
DX1000/DX1000N Operation Guide	IM 04L41B01-02E	This is the electronic version of the paper manual.
DX1000/DX1000N User’s Manual	IM 04L41B01-01E	Describes how to use the DX. The communication and network functions, custom display functions, and some of the options are excluded.
DX1000/DX1000N/DX2000 Multi Batch (/BT2) User’s Manual	IM 04L41B01-03E	Describes how to use the multi batch function (/BT2 option).
DX1000/DX1000N/DX2000 Custom Display User’s Manual	IM 04L41B01-04E	Describes how to use the custom display function.
DX1000/DX1000N/DX2000 Advanced Security Function (/AS1) User’s Manual	IM 04L41B01-05EN	Describes how to use the advanced security function (/AS1 option).
DX1000/DX1000N/DX2000 Communication Interface User’s Manual	IM 04L41B01-17E	Describes how to use communication functions through an Ethernet or serial interface.
DX1000/DX1000N/DX2000 EtherNet/IP Communication Interface User’s Manual	IM 04L41B01-18E	Describes how to use communication functions through an EtherNet/IP interface.
DX1000/DX1000N/DX2000 PROFIBUS-DP (/CP1) Communication Interface User’s Manual	IM 04L41B01-19E	Describes how to use communication functions through the PROFIBUS-DP interface (/CP1 option).

- **DAQSTANDARD Manuals**

All manuals other than IM 04L41B01-66EN are contained in the DAQSTANDARD CD.

Manual Title	Manual No.
DAQSTANDARD Data Viewer User’s Manual	IM 04L41B01-63EN
DAQSTANDARD Hardware Configurator User’s Manual	IM 04L41B01-64EN
DAQSTANDARD DX100P/DX200P Configurator User’s Manual	IM 04L41B01-65EN
Installing DAQSTANDARD	IM 04L41B01-66EN

Notes

- The contents of this manual are subject to change without prior notice as a result of continuing improvements to the instrument's performance and functions.
- Every effort has been made in the preparation of this manual to ensure the accuracy of its contents. However, should you have any questions or find any errors, please contact your nearest YOKOGAWA dealer.
- Copying or reproducing all or any part of the contents of this manual without YOKOGAWA's permission is strictly prohibited.
- The TCP/IP software of this product and the document concerning the TCP/IP software have been developed/created by YOKOGAWA based on the BSD Networking Software, Release 1 that has been licensed from the Regents of the University of California.

Trademarks

- vigilantplant, DAQSTATION, Daqstation, and DXAdvanced are registered trademarks of Yokogawa Electric Corporation.
- Microsoft and Windows are registered trademarks or trademarks of Microsoft Corporation in the United States and/or other countries.
- Adobe and Acrobat are registered trademarks or trademarks of Adobe Systems Incorporated.
- Kerberos is a trademark of the Massachusetts Institute of Technology (MIT).
- Company and product names that appear in this manual are registered trademarks or trademarks of their respective holders.
- The company and product names used in this manual are not accompanied by the registered trademark or trademark symbols (® and ™).

Revisions

1st edition:	December 2005
2nd edition:	October 2006
3rd edition:	April 2007
4th edition:	December 2007
5th Edition:	November 2008
6th edition:	March 2010
7th edition:	December 2010

DX's Version and Functions Described in This Manual

The contents of this manual corresponds to the DX with release number 4 and style number 3.

DX's Version and Functions

For the procedure to check the version, see section 2.5.

Edition	DX	Addition and change to functions	Refer to
2	Version 1.11	(Added) German, French, and Chinese as display language.	Section 2.6
		(Added) Modbus client connection retry interval: 10 s, 20 s, and 30 s.	Section 1.0 in IM04L41B01-17E
		(Added) 24 VDC/AC power supply (/P1 option).	IM04L41B01-02E
	Version 1.21	(Added) Tab key on the USB keyboard corresponds to arrow keys.	Section 2.11
		(Added) Operations to request and release network information.	Section 1.3 in IM04L41B01-17E
		(Changed) Modbus client: Function to connect a server with a unit number is changed.	Section 1.10 in IM04L41B01-17E
		(Added) Modbus client: Connection timeout value.	Section 1.10 in IM04L41B01-17E
		(Added) Modbus registers (floating point type for communication input data).	Section 6.3 in IM04L41B01-17E
		(Added) A data output format (Skip or OFF channel data not output).	Section 3.7 in IM04L41B01-17E CB command
		(Changed) Error messages 105, 221, and 222 are added.	Section 10.1
(Changed) Error messages 215, 218, and 536 are changed.	Section 10.1		
3	Release number 2 (Version 2.0x)	(Added) Improvement to the operability on the historical trend display.	Section 4.3
		(Changed) Displaying the date in the grid time of the trend display when the trend interval is greater than or equal to 1 h/div.	Sections 1.3 and 2.4
		(Added) Improvement to the display group setup operation.	Section 5.1
		(Added) Addition of the Upper and Lower settings to the bar graph base position.	Section 5.11
		(Added) Addition of the relay action when alarm ACK is executed to the alarm output relay settings.	Sections 1.2, 3.5, and 3.8
		(Added) Ability to reset the computed value during computation.	Section 9.4
		(Changed) Changes to how the data files are named.	Section 1.4
		(Added) Sorting the files by the update date/time.	Sections 6.7, 6.8, and 6.9
		(Added) Storage method for constantly retaining the most recent data files in the CF card (Media FIFO).	Sections 1.4 and 6.2
		(Added) Progress display when saving all data of the internal memory.	Sections 4.8
		(Changed) Changing the initial display selection menu.	Sections 4.8 and 5.17
		(Changed) Improvement to the data save operation to the USB flash memory.	Sections 2.12 and 5.17
		(Changed) Retaining the state of the CapsLock and NumLock keys on the USB keyboard.	Section 2.11
		(Changed) Changing the default setting of the web server function.	IM04L42B01-02E, Section 1.5 in IM04L41B01-17E
	(Added) Error messages, 513, 514, 515, and 516 have been added.	Section 10.1	
Style number 2	(Added) The waterproof construction of the DX front panel complies with the NEMA4 standard.	Section 12.6	
4	Same as edition 3	Added explanations. Fixed explanations.	-
		Changed the direction of the clamp input terminal (/H2 option).	IM04L4101-02E

DX's Version and Functions Described in This Manual

Edition	DX	Addition and change to functions	Refer to
5	Release number 3 (Version 3.0x)	Divided the setting mode displays with tabs.	All setting displays
Added method for switching from setting mode to basic setting mode.		Section 2.14	
Improved numeric input operation.		Numeric input display	
Added the ability to input the following characters: [] and :.		Character string input display	
Added new input type (GOST; /N3 option).		Section 3.3	
Increased measurement range for TC Type N.		Section 12.5	
Custom display.		IM04L41B01-04E.	
Multi Batch (/BT2 option).		IM04L41B01-03E	
Alarm level display.		Section 3.7	
Alarm annunciator.		Section 3.12	
Common alarm (/F1 option).		Section 2.9	
32-character tag comments and 16-character tag numbers.		Section 5.2	
Faster display update interval.		Section 3.1	
Secondary trend interval changeable during recording.		Section 5.3	
Added 15-, 20-, and 30-minute event data sample rates.		Section 6.1	
Fine grid.		Sections 4.2 and 4.3	
Auto zone display.		Sections 4.2 and 4.3	
Indication that the DX is waiting for a trigger.		Section 1.3	
Decimal point types "Point" and "Comma".		Section 2.13	
Added favorite key operations.		Section 5.15	
Data searching with date and time.		Section 4.3	
Historical trend relative time display, auto span display, and top channel display.		Section 4.3	
Number of batch text fields changed to 24.		Section 6.3	
The start recording screen appears when you press the start key while using the batch function.		Section 6.3	
Changed contents of the system and network information displays.		Section 2.5	
Limits on setting load function.		Section 8.1	
Event switch.		Section 7.1	
Added "CommentDisplay" and "FavoriteDisplay" actions to the event action function.		Section 7.1	
Remote control contact input changed from operating on Close to operating on Open (/R1 and /PM1 options).		Section 7.1	
Match time timer reset (/M1 and /PM1 Options).		Section 7.1	
Added "Year" to match time timer conditions (/M1 and /PM1 options)		Section 7.1	
Match time timer usable for TLOG computation (/M1 and /PM1 options).		Section 9.1	
Stacked bar graphs for report data (/M1 and /PM1 options).		Section 4.10	
Added recording condition variables to equations (/M1 and /PM1 options).	Section 1.8		
Added USB barcode reader support (/USB1 option).	Section 2.11		
Saving of data from the internal memory to USB flash memory or a CF card (/USB1 option).	Section 2.12		
Added data searching, report layout display, a print button, and an FTP link to the Web server function.	Section 1.5 in IM04L41B01-17E		
Modbus register map expansion and floating-point data writing.	Section 6.3 in IM04L41B01-17E		
Only send alarm e-mails when an alarm has occurred.	Section 1.4 in IM04L41B01-17E		
Added tag and channel number to alarm e-mails.	Section 1.4 in IM04L41B01-17E		
E-mail transfer authentication (Pop Before SMTP).	Section 1.4 in IM04L41B01-17E		
"°C" displayed in e-mails and the Web settings.	Section 1.5 in IM04L41B01-17E		
Added the ability to input the square and cube characters (² and ³) in communications (only for English, German, and French).	Appendix 3 in IM04L41B01-17E		
Added FTP data transfer wait operation.	Section 1.7 in IM04L41B01-17E		
FTP server directory output format can be set to MS-DOS and UNIX.	Section 1.6 in IM04L41B01-17E		
EtherNet/IP.	IM04L41B01-18E		
PROFIBUS-DP (/CP1 option).	IM04L41B01-19E		
Style number 3	Changed the boot ROM.	-	

DX's Version and Functions Described in This Manual

Edition	DX	Addition and change to functions	Reference	
6	Release number 4	Advanced security function (/AS1 option).	IM04L41B01-05EN	
		Report template (/M1 and /PM1 options).	Section 9.6	
	(Version 4.0x)	Added the "Seprt2" report file separation method.	Section 9.5	
		Calibration management (/CC1 option).	Section 3.13	
	Style number 3	Added functions and improvements to the custom display. The main changes are listed below. The status display section can be hidden. Items have been added (system icons, group names, memory bar, date and time labels, batch group numbers, batch names, Modbus input). Custom grids can be displayed on the trend display. The bitmap data of the INTERNAL 1 to 3 screens is saved to internal memory. Labels and tags can be displayed vertically. Additional types of current value marks for the scale have been added. The scale unit indication can be hidden. Time can be displayed on all grids on the trend display. Group switching can be stopped.		IM04L41B01-04E
		Added an alarm sound to the Web server function.		Section 1.5 in IM04L41B01-17E
		The DX outputs the Modbus input value specified in the custom display. The "E-M" command has been added for the Modbus client and master.		Sections 1.10 and 2.6 in IM04L41B01-17E IM04L41B01-04E
		Authenticated e-mail transmission (Authentication SMTP).		Section 1.4 in IM04L41B01-17E
		A switch from on to off can be specified as an event.		Section 7.1
		The duration for which the reflash relays are deactivated can be set to 500 ms, 1 s, or 2 s.		Section 3.5
		Added new input type (Pt200(WEED); /N3 option).		Section 3.3
		Text fields can be input when the batch function is being used and recording starts.		Section 6.3
		The length of the user password that can be registered with the login function has been extended to 20 characters.		Section 8.2
Operations can be assigned to the output relays (/F1 and /F2 options).		Section 2.9		
Models with 400 MB of internal memory have been added (internal memory size suffix code: "-3").		IM04L42B01-02E MODEL and SUFFIX Code		
7	Same as edition 6	Additions and improvements to explanations.	-	

How to Use This Manual

Structure of the Manual

Read the **Operation Guide** first to familiarize yourself with the basic operation, and then read this manual. For a description of the communication function and the accompanying software program, DAQSTANDARD, read the respective manual.

This user's manual consists of the following sections.

Chapter	Title and Contents
1	Overview of Functions Describes the functions of the DX.
2	Common Operations Describes the procedure to set the time and the operating procedure using the remote control terminal (/KB1 or /KB2 option) and keyboard (/USB1 option).
3	Measurement Channels and Alarms Describes how to set the measurement conditions and alarms.
4	Switching Operation Screens Describes the operations on the operation screen.
5	Operations for Changing the Displayed Contents Describes how to change the displayed contents on the operation screen and how to write messages.
6	Saving and Loading Data Describes how to acquire and store the data. Also describes the procedure to load measured data/setup data on the CF card or the USB flash memory (/USB1 option).
7	Customizing Actions Using the Event Action and Remote Control Functions (/R1 and /PM1 Options) Describes how to carry out specific actions when a given event occurs, when a remote control signal is applied, and when the USER key is pressed.
8	Using the Security Function Describes how to use the key lock function and the function that allows only registered users to operate the DX.
9	Computation and Report Functions (/M1 and /PM1 Options) Describes how to use computation channels and how to create reports such as hourly, daily, weekly, and monthly reports.
10	Troubleshooting Describes error messages and troubleshooting.
11	Maintenance Describes periodic inspection and calibration.
12	Specifications Lists the specifications of the DX.
Appendix	Describes how to estimate the file size, the types of data that the DX can generate and how to use them, the data format of text files, etc.
Index	

Note

- This user's manual covers information regarding DX1000s that have a suffix code for language "-2" (English).
 - For details on setting the display language, see section 2.6, "Changing the Displayed Language."
-

Conventions Used in This Manual

Unit

K	Denotes 1024. Example: 768 KB (file size)
k	Denotes 1000.

Markings



Improper handling or use can lead to injury to the user or damage to the instrument. This symbol appears on the instrument to indicate that the user must refer to the user's manual for special instructions. The same symbol appears in the corresponding place in the user's manual to identify those instructions. In the manual, the symbol is used in conjunction with the word "WARNING" or "CAUTION."

WARNING

Calls attention to actions or conditions that could cause serious or fatal injury to the user, and precautions that can be taken to prevent such occurrences.

CAUTION

Calls attentions to actions or conditions that could cause light injury to the user or damage to the instrument or user's data, and precautions that can be taken to prevent such occurrences.

Note

Calls attention to information that is important for proper operation of the instrument.

Subheadings

Bold characters Denotes key or character strings that appear on the screen. Example: **Volt**



Indicates character types that can be used.
 A Uppercase alphabet, a lowercase alphabet, # symbols, 1 numbers.

Procedure

Carry out the procedure according to the step numbers.

Explanation

All procedures are written with inexperienced users in mind; depending on the operation, not all steps need to be taken. Explanation gives information such as limitations related the procedure.

Setup Screen

Indicates the setup screen and explains the settings. A detailed description of the function is not provided in this section.

Setup Items

For details on the function, see chapter 1.

Contents

DX's Version and Functions Described in This Manual	iii
How to Use This Manual	vi

Chapter 1 Overview of Functions

1.1 Input Section	1-1
1.2 Alarms	1-4
1.3 Display	1-9
1.4 Data Storage Function	1-26
1.5 Batch Function	1-36
1.6 Event Action and Remote Control Functions (/R1 and /PM1 Options)	1-37
1.7 Security Function	1-42
1.8 Computation and Report Function (/M1 and /PM1 Options)	1-44
1.9 FAIL/Status Output Function (/F1 Option)	1-52
1.10 Other Functions	1-54

Chapter 2 Common Operations

2.1 Setting the Date/Time	2-1
2.2 Setting the Time Difference from GMT	2-2
2.3 Setting the Time Correction Operation during Memory Sampling	2-3
2.4 Setting the Date Format	2-4
2.5 Viewing the DX Information	2-5
2.6 Changing the Displayed Language	2-7
2.7 Setting the LCD Brightness and Backlight Saver	2-8
2.8 Initializing Settings and Clearing the Internal Memory	2-9
2.9 Outputting the DX Status via the Relay Contact (/F1 Option)	2-11
2.10 Controlling the DX with the Remote Control Terminal (/KB1 and /KB2 Options)	2-14
2.11 Controlling the DX with a Keyboard or Barcode Reader (/USB1 option)	2-19
2.12 Using the USB Flash Memory (/USB1 Option)	2-24
2.13 Setting the Decimal Point Type (Release number 3 or later)	2-26
2.14 Showing or Hiding the Menu Item for Switching from Setting Mode to Basic Setting Mode (Release number 3 or later)	2-27

Chapter 3 Measurement Channels and Alarms

3.1 Setting the Scan Interval and the Integration Time of the A/D Converter	3-1
3.2 Setting the Burnout Detection and the Reference Junction Compensation of the Thermocouple Input	3-2
3.3 Setting the Input Range	3-3
3.4 Setting the Moving Average of the Input	3-6
3.5 Setting the Auxiliary Alarm Function	3-7
3.6 Hiding the Alarm Indication	3-10
3.7 Setting Alarms on Channels	3-11
3.8 Releasing the Alarm Output (Alarm ACK Operation)	3-15
3.9 Performing Calibration Correction (/CC1 Option)	3-16
3.10 Counting Pulses (/PM1 Option)	3-17
3.11 Setting the Method of Detecting Over-Range Values of Linearly Scaled Measurement Channels	3-20
3.12 Using the Alarm Annunciator Function (Release number 3 or later)	3-21
3.13 Managing the Input Calibration Interval (/CC1 option; release numbers 4 and later)	3-30

Chapter 4 Switching Operation Screens

4.1 Operations in Operation Mode..... 4-1

4.2 Displaying the Measured Data as Waveforms, Values, or Bar Graphs 4-4

4.3 Displaying Past Measured Data (Historical Trend Display) 4-9

4.4 Display the Statuses of All Channels on One Screen (Overview Display)..... 4-22

4.5 Displaying Various Information 4-25

4.6 Using the Alarm Summary 4-28

4.7 Using the Message Summary..... 4-30

4.8 Using the Memory Summary 4-32

4.9 Displaying a List of Operation Logs 4-35

4.10 Displaying Stacked Bar Graphs (/M1 and /PM1 options; release number 3 or later) 4-40

Chapter 5 Operations for Changing the Displayed Contents

5.1 Setting Display Groups 5-1

5.2 Displaying Tags or Channel Numbers..... 5-3

5.3 Setting the Trend Interval and Switching to the Secondary Trend Interval 5-5

5.4 Writing Messages 5-7

5.5 Changing the Channel Display Colors..... 5-10

5.6 Displaying Channels in Display Zones 5-11

5.7 Displaying a Scale on the Trend Display 5-12

5.8 Displaying Alarm Point Marks and Color Scale Band on the Scale 5-15

5.9 Partially Expanding the Waveform..... 5-17

5.10 Changing the Display Layout, Clearing of the Waveform at Start, Message Display Direction, Waveform Line Width, and Grid..... 5-19

5.11 Changing the Bar Graph Display Method 5-20

5.12 Changing the Background Color of the Display 5-23

5.13 Automatically Switching Display Groups 5-24

5.14 Automatically Switching Back to the Default Display..... 5-25

5.15 Using the Favorite Key 5-26

5.16 Writing a Message When the DX Recovers from a Power Failure 5-28

5.17 Changing the FUNC Key Menu and Display Selection Menu..... 5-29

5.18 Displaying Comments (Release number 3 or later)..... 5-33

Chapter 6 Saving and Loading Data

6.1 Setting the Recording Conditions of the Measured Data..... 6-1

6.2 Setting the Method for Saving the Data..... 6-4

6.3 Using the Batch Function..... 6-6

6.4 Starting/Stopping the Recording and Saving the Measured data..... 6-10

6.5 Manually Saving the Measured Data (Manual Sample) 6-14

6.6 Saving the Screen Image Data (Snapshot) 6-15

6.7 Managing the Files on the Storage Medium..... 6-16

6.8 Loading and Displaying the Measured Data in the Storage Medium..... 6-18

6.9 Saving/Loading the Setup Data 6-19

6.10 Loading and Saving Report Templates (/M1 and /PM1 options; release numbers 4 and later)..... 6-22

1

2

3

4

5

6

7

8

9

10

11

12

App

Index

Chapter 7	Customizing Actions Using the Event Action and Remote Control Functions (/R1 and /PM1 Options)	
7.1	Setting the Event Action Function (Including the remote control function of the /R1 and /PM1 options and the USER key)	7-1
7.2	Setup Examples of Event Action.....	7-7
7.3	Changing the Response to Remote Contact Input Opening and Closing (/R1 and /PM1 options; release number 3 or later).....	7-10
Chapter 8	Using the Security Function	
8.1	Disabling the Key Operation (Key Lock Function).....	8-1
8.2	Enabling Only Registered Users to Operate the DX (Login Function).....	8-3
8.3	Logging in and Logging Out.....	8-6
Chapter 9	Computation and Report Functions (/M1 and /PM1 Options)	
9.1	Setting the Expression, Measurement Range, Alarm, Tag, and Data Storage on Computation Channels.....	9-1
9.2	Writing Expressions	9-5
9.3	Displaying the Computation Channels.....	9-11
9.4	Starting/Stopping Computation, Resetting Computation, and Releasing Computation Data Dropout Display	9-14
9.5	Creating Reports.....	9-16
9.6	Creating a Report Template (Release numbers 4 and later)	9-19
Chapter 10	Troubleshooting	
10.1	A List of Messages.....	10-1
10.2	Troubleshooting	10-20
Chapter 11	Calibration	
11.1	Periodic Inspection	11-1
11.2	Calibrating the DX.....	11-2
11.3	Pulling Out the Inner Instrument (DX1000N).....	11-4
Chapter 12	Specifications	
12.1	Signal Input and Alarm.....	12-1
12.2	Display Function	12-3
12.3	Data Saving Function	12-6
12.4	Other Standard Functions.....	12-9
12.5	Options	12-11
12.6	General Specifications.....	12-19
12.7	External Dimensions.....	12-24
Appendix		
Appendix 1	File Size of Display Data and Event Data	App-1
Appendix 2	Types of Data Files That the DX Can Create and Their Application	App-4
Appendix 3	Text File Data Format.....	App-5

Index

1.1 Input Section

Measurement Channel

- **Number of Measurement Channels and Scan Interval**

The DX samples the input signals on the measurement channels at the scan interval to obtain the measured values. The table below shows the relationship between the number of measurement channels and the scan interval.

Model	No. of Measurement Channels	Scan Interval		
		Normal Mode		Fast Sampling Mode*
DX1002, DX1002N	2	125 ms, 250 ms		25 ms
DX1004, DX1004N	4			
DX1006, DX1006N	6	1 s, 2 s, 5 s	2 s, 5 s	125 ms
DX1012, DX1012N	12			
A/D Converter Integration Time		60 Hz/50 Hz	60 Hz/50 Hz/100 ms	600 Hz (fixed)

* When using the multi batch function (/BT2) the DX do not have a fast sampling mode. For the setting procedure, see section 3.1.

- **Integration Time of the A/D Converter**

The DX uses an A/D converter to convert the sampled analog signal to a digital signal. By setting the integration time of the A/D converter to match the time period corresponding to one cycle of the power supply or an integer multiple of one cycle, the power supply frequency noise can be effectively eliminated.

- Because 100 ms is an integer multiple of 16.7 ms and 20 ms, this setting can be used to eliminate the power frequency noise for both frequency, 50 Hz and 60 Hz.
- In fast sampling mode, the performance of eliminating power frequency noise is worse than in normal mode. We recommend that you use normal mode when making measurements in an environment affected by power frequency noise.

For the setting procedure, see section 3.1.

Input Type and Computation

You can make measurements using the following input types.

Input Type	Description
DC voltage	You can measure DC voltages in the range of ± 20 mV to ± 50 V.
DC current	You can measure a DC current signal by converting it to a voltage signal using a shunt ^{*1} resistor attached to the input terminal. The converted signal can be measured within the DC voltage range (see above).
Thermocouple	You can measure temperatures corresponding to these thermocouple types: R, S, B, K, E, J, T, N, W, L, U, and WRe3-25. It is also possible to measure using other thermocouples, such as PR40-20 and PLATINEL. ^{*2}
RTD	You can measure temperatures using RTD types Pt100 and JPt100. It is also possible to measure using other RTD types such as Cu10, Cu25, ^{*3} Pt50, and Ni100. ^{*2}
ON/OFF input	You can display contact input or voltage input signals correlated to 0% or 100% of the display range. Contact input: A closed contact is on (1). An open contact is off (0). Voltage input: Less than 2.4 V is off (0). 2.4 V or more is on (1).
Pulse input ^{*4}	You can count pulses.

*1 Item sold separately. For example, you can use a 250- Ω shunt resistor to convert a 4- to 20-mA signal to a 1- to 5-V signal.

*2 /N3 option

*3 /N1 option

*4 /PM1 option

1.1 Input Section

The following input processing and computation are available.

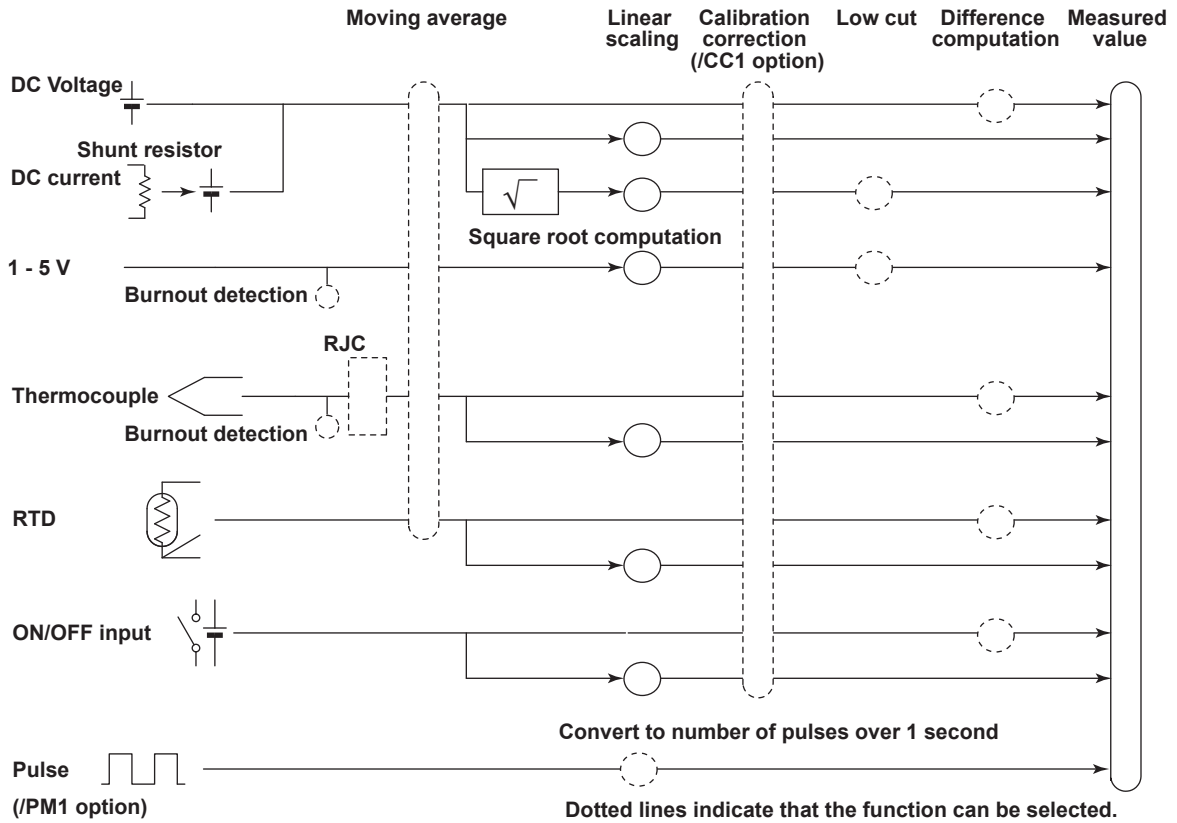

Reference Junction Compensation	Burnout Detection								
<p>Performs reference junction compensation on the thermocouple.</p> <p>For the setting procedure, see section 3.2.</p>	<p>Detects and indicates a burnout in the sensor.</p> <p>Burnout </p> <p>Burnout </p> <p>For the setting procedure, see section 3.2.</p>								
Moving Average									
<p>Eliminates noise.</p> <p>Operation example when the number of moving average data points is 3</p> <table border="1" style="margin-left: auto; margin-right: auto;"> <tr> <td style="text-align: center;">1</td> <td style="text-align: center;">10.0 mV</td> <td rowspan="3" style="text-align: center;">↓ New sampled data</td> <td rowspan="3" style="text-align: center;">↓ New sampled data</td> </tr> <tr> <td style="text-align: center;">2</td> <td style="text-align: center;">5.0 mV</td> </tr> <tr> <td style="text-align: center;">3</td> <td style="text-align: center;">0.0 mV</td> </tr> </table> <p>Number of moving average data points: 2 to 400</p> <p> </p> <p>For the setting procedure, see section 3.4.</p>		1	10.0 mV	↓ New sampled data	↓ New sampled data	2	5.0 mV	3	0.0 mV
1	10.0 mV	↓ New sampled data	↓ New sampled data						
2	5.0 mV								
3	0.0 mV								

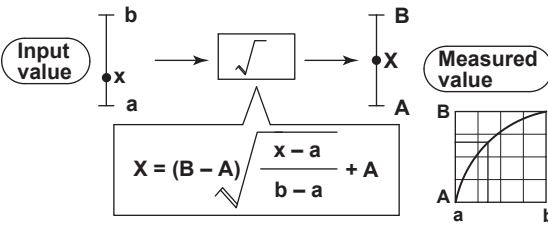
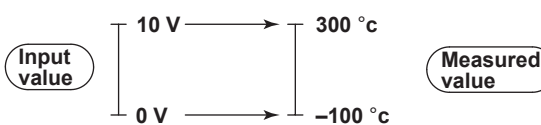
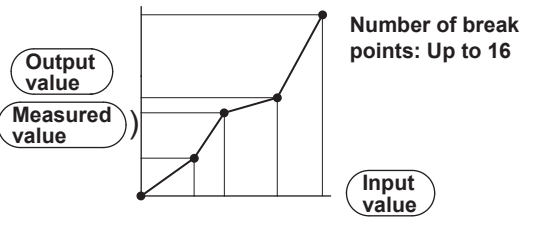
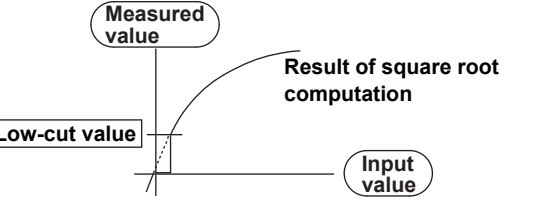
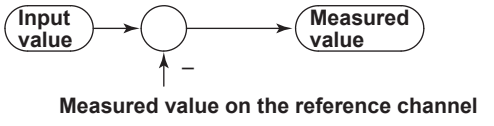
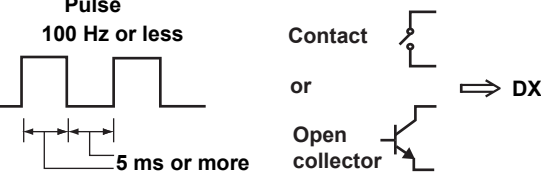
<p>Square Root Computation</p> <p>Takes the square root of the input value and converts the unit to obtain the measured value.</p>  $X = (B - A) \sqrt{\frac{x - a}{b - a}} + A$ <p>For the setting procedure, see section 3.3.</p>	<p>Linear Scaling</p> <p>Converts the unit to obtain the measured value.</p>  <p>For the setting procedure, see section 3.3.</p>
<p>Calibration Correction (/CC1 Option)</p> <p>Corrects the input value with the characteristics specified by segments to obtain the measured value.</p>  <p>For the setting procedure, see section 3.9.</p>	<p>Low-cut</p> <p>For square root computation, measured values below the specified value are cut. For 1-5 V input, values below 0 % are cut.</p>  <p>For the setting procedure, see section 3.3.</p>
<p>Difference computation</p> <p>The measured value of the channel is set to the difference with respect to the measured value of the reference channel.</p>  <p>For the setting procedure, see section 3.3.</p>	<p>Pulse Input (/PM1 Option)</p> <p>Pulse that can be counted Input to the DX</p>  <p>Count on the DX The contact changes from open to close. The signal level at the input terminal changes from high to low.</p> <p>For the setting procedure, see section 3.10.</p>

Note

Difference computation is executed even if the input type or range is not the same between the difference computation channel and the reference channel. The difference is computed discarding the decimal place and unit, and the decimal place and unit of the difference computation channel are applied.

Example 1: If the input value of the difference computation channel is 10.00 and the measured value of the reference channel is 100.0, the computed result is $10.00 - 100.0 = -90.00$.

Example 2: If the input value of the difference computation channel is 10.00 V and the measured value of the reference channel is 5.00 mV, the computed result is $10.00 \text{ V} - 5.00 \text{ mV} = 5.00 \text{ V}$.

Calibration Management (/CC1 option; release numbers 4 and later)

You can use this function to make sure that calibration is performed regularly. When you enable calibration management, a screen (the calibration notification screen) appears to notify you in advance that the calibration due date is approaching. For the setting procedure, see section 3.13.

1.2 Alarms

This function generates an alarm when the measured data meets a certain condition. Up to four alarms can be set for each channel.

Alarm Type

You can use the alarms shown below. The character inside the parentheses is the symbol denoting each alarm.

For the alarm setting procedure, see section 3.7.

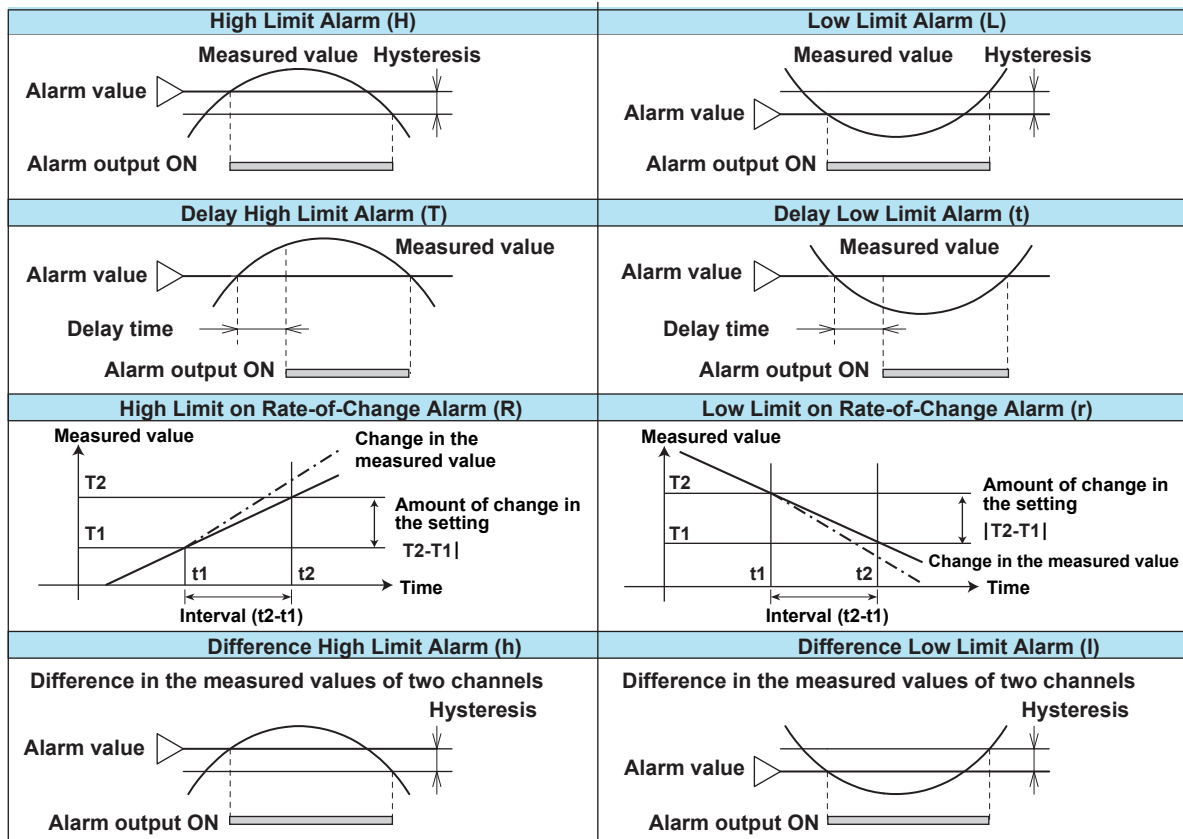

- **Alarm Hysteresis**

You can set a width (hysteresis) to the value used to activate and release alarms.

- **Delay High Limit Alarm and Delay Low Limit Alarm**

An alarm occurs when the measured value remains above or below the alarm value for a specified time period (delay period).

- **High Limit on Rate-of-Change Alarm and Low Limit on Rate-of-Change Alarm**

The rate-of-change of the measured values is checked over a certain time (interval). An alarm occurs if the rate-of-change of the measured value in the rising/falling direction is greater than or equal to the specified value.

The alarm value of the rate-of-change alarm is set using an absolute value. The interval is derived using the following equation and set using the number of samples.

$$\text{Interval} = \text{the scan interval} \times \text{the number of samples}$$

For the setting procedure, see section 3.5.

- **Difference Upper Limit Alarm and Difference Lower Limit Alarm**

An alarm occurs when the difference in the measured values of two channels is greater/less than or equal to the specified value. These alarms can be specified on measurement channels set to difference computation.

Alarm Indication

The alarm conditions are displayed as alarm icons in the status display section and on the operation screen such as the trend, digital, bar graph, overview displays. Detailed information about the alarms is displayed in the alarm summary.

- **Alarm Levels and Colors (Release number 3 or later)**

You can set separate levels and colors for the four alarms on a single channel. When multiple alarms occur, the DX gives higher priority to the display of alarms with higher levels. It is easy to understand what processes are taking place when alarms occur if you associate an alarm's color with its level. Level and color settings are the same for each channel.

- In the overview display, the channel display area appears in the color of the alarm that has occurred.

1	H 1.9984 V	7	0.0785 V
2	H 1.9506 V	8	-0.4413 V
3	1.7699 V	9	-0.9312 V
4	1.4686 V	10	-1.3576 V
5	1.0672 V	11	-1.6914 V
6	0.5930 V	12	-1.9100 V

- The following items also appear in the color of the alarm that has occurred.
 - Alarm marks in the trend, digital, and bar graph displays
 - The alarm point marks on scales (when they are set to "Alarm")
 - The alarm occurrence mark in the alarm summary

When multiple alarms occur on the same channel, the various displays respond as described below:

- In the overview display, the channel display area is displayed using the color of the alarm with the highest priority level.
- In the trend and digital displays, the alarm type is displayed using the symbol for the alarm with the highest priority level.
- In the annunciator display, the display window is displayed using the color of the alarm with the highest priority level.

For the setting procedure, see section 3.7.

- **Alarm-Activated Text Display (Release number 3 or later)**

Using the Event Action function, you can display a previously set string of text (comment text block) when an alarm occurs.

For the procedure to set comment text blocks and event action, see sections 5.18 and 7.1, respectively.

- **Hold/Non-hold of Indications**

The alarm indication can be set to operate in the following fashion when the condition is no longer met.

- Clear the alarm indication (non-hold).
- Hold the alarm indication until the alarm ACK operation is executed (hold).

The default setting is non-hold.

For the setting procedure, see section 3.5.

- **Alarm Hide Function**

No indication is made when an alarm occurs. The alarm is also not recorded in the alarm summary. The alarm is output to the relay (/A[] option) or internal switch. This function can be set for each channel and each alarm.

For the setting procedure, see section 3.6.

Alarm Output Relay Operation

Contact signals can be generated from alarm output relays (/A_ option) when alarms occur. The alarm output relay operation can be changed.

For the setting procedure, see section 3.5.

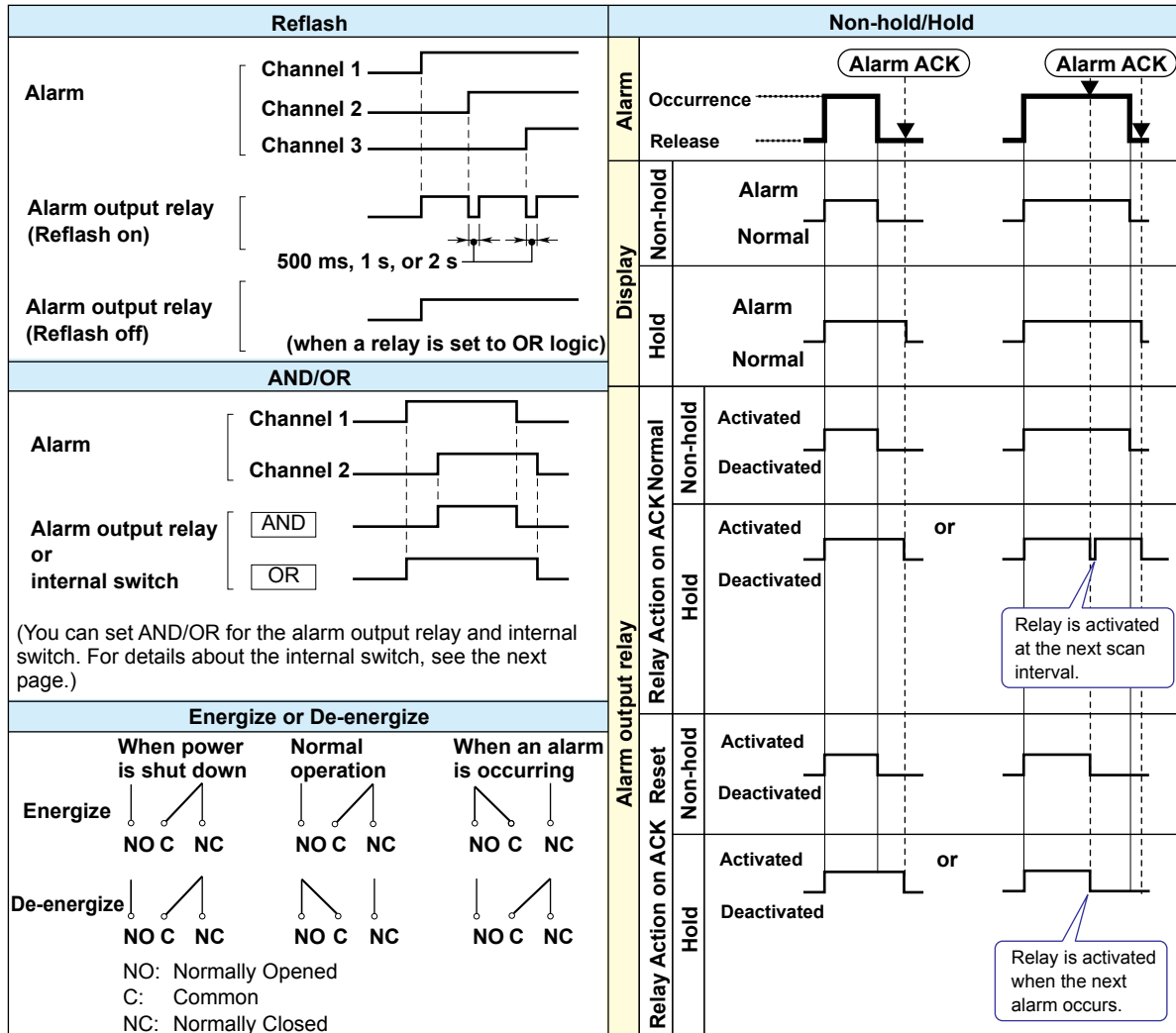

• **Reflash**

When multiple alarms are assigned to one alarm output relay, this function notifies the occurrence of subsequent alarms after the relay is activated by the first alarm. When subsequent alarms occur, the output relay is released temporarily. The duration for which the relays are deactivated can be set to 500 ms, 1 s, or 2 s.

The reflash function is set on the first three output relays.

* I01 to I03. I01 and I02 for the /A1 option.

Note

When reflash is enabled, the first three output relays are used exclusively as reflash relays.

The first three output relays are set to OR logic and de-energize operation regardless of the AND/OR and energize/de-energize settings explained below.

• **AND/OR**

When multiple alarms are assigned to one alarm output relay, the condition for activating the output relay can be selected from the following: You can select AND operation also for the internal switch.

- AND: Activated when all assigned alarms are occurring simultaneously.
- OR: Activated when any of the specified alarms is occurring.

- **Energize or De-energize Operation**

You can select whether the alarm output relay is energized or de-energized when an alarm occurs. If de-energized is selected, the status of the alarm output relay when an alarm occurs is the same as the status that results when the DX power is shut down. The setting applies to all alarm output relays.

- **Non-Hold/Hold**

The alarm output relay can be set to operate in the following fashion when the alarm condition is no longer met.

- Turn OFF the relay output (non-hold).
- Hold the relay at ON until the alarm ACK operation is executed (hold).

The setting applies to all alarm output relays.

- **Alarm ACK Operation**

The alarm acknowledge (alarm ACK) operation releases all alarm indications and relay outputs. For the action of alarm indication and alarm output relay when you carried out the alarm ACK operation, see the previous page.

- **Individual Alarm ACK Operation (Only on DXs with the /AS1 advanced security option)**

This operation releases the relay output of individual alarms. This operation is referred to as "individual alarm ACK." For information about how alarm display and output relay operations respond to an individual alarm ACK, see the previous page. You can perform individual alarm ACK from the overview display.

For operating instructions, see section 4.4.

Note

When you enter the basic setting mode, the hold/non-hold condition of the alarm output relay immediately before is retained. In the basic setting mode, alarms are not detected, and you cannot acknowledge alarms.

Internal Switch

The alarm status can be output to software switches (30 internal switches). The values of the internal switch are shown below. Like the alarm output relay, you can specify AND/OR operation (see the previous page). The internal switches cannot be operated other than for alarm output.

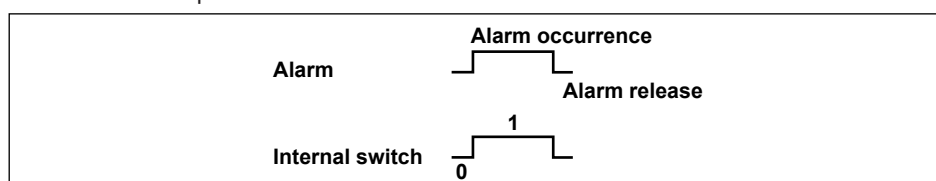

The internal switches can be used events of the event action function (see section 1.6). In addition, the internal switches can be written in calculation expressions of computation channels (/M1 or /PM1 option).

Alarm Annunciator Function (Release number 3 or later)

You can use the DX as an alarm annunciator. No lock-in, lock-in, and double lock-in sequences are supported. The alarm display and alarm output relay operations follow the annunciator sequence.

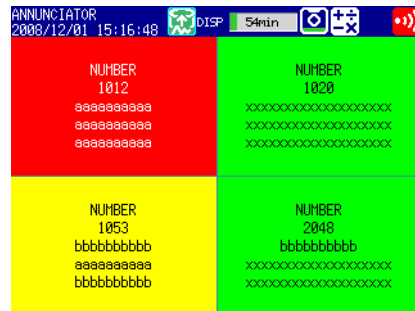

For the setting procedure, see section 3.12.

1.3 Display

Common Items Related to the Display

- **5.5-inch TFT Color LCD and the Screen Configuration**

The DX has a 5.5-inch TFT color LCD (240 × 320 dot resolution). The screen consists of the status display section and the data display section.

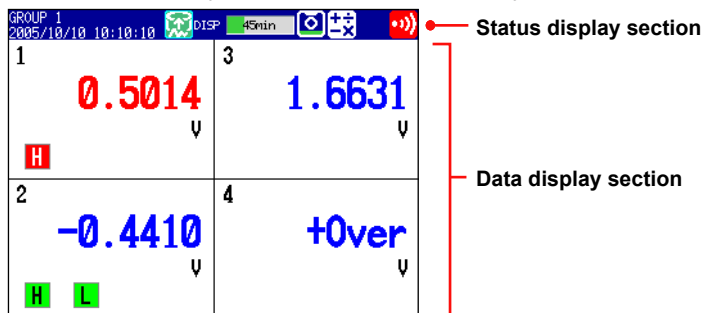

- **Status Display Section**

The status display section shows the display name, date/time, batch name (when using the batch function), user name (when using the login function), usage of the internal memory or CF card, alarm occurrence, computation status (/M1 or /PM1 option), and usage of key lock or e-mail transmission.

- **Data Display Section**

The data display section shows the measured data using numeric values, waveforms, and bar graphs. It also shows the setup screen when setting functions.

- **Group Display**

On the trend, digital, and bar graph displays, the data of channels is displayed by groups that are set in advance. Up to 10 groups can be registered, and up to six channels can be assigned to each group. Groups are common to the trend, digital, and bar graph displays.

The displayed group can be switched automatically at a specified time interval (5 s to 1 min).

For the setting procedure, see section 5.1.

- **Channel Number Display and Tag Display**

You can choose to label displayed channels according to their tags or according to their channel numbers. In the tag display, you can display tag numbers and comments. This setting applies to all channels.

For the setting procedure, see section 5.2. For the tag number and tag comment display example, see section 4.2.

- **Update Interval of Measured Values**

The values are updated every second. However, if the scan interval is greater than 1 s, the values are updated at the scan interval.

For the setting procedure, see section 5.3.

- **Alarm Indication**



Alarms that are set for each channel are checked at all times and are indicated with the symbol representing the alarm type on each display.

Alarm Type	Symbol	Alarm Type	Symbol
High limit alarm	H	High limit on rate-of-change alarm	R
Low limit alarm	L	Low limit on rate-of-change alarm	r
Difference high limit alarm	h	Delay high limit alarm	T
Difference low limit alarm	l	Delay low limit alarm	t

Status Display Section

The following information is displayed in the status display section during operation mode or setting mode.





Memory sampling status

Memory sampling stopped  **Data type**
Memory sampling in progress  **DISP: Display data**
Memory sampling icon  **EVENT: Event data**

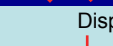
Memory sampling progress
 Displays the progress using a green bar graph. The frame indicates the file save interval (display data) or the data length (event data).

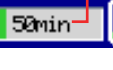
 **Error in internal memory.**
 Contact your nearest YOKOGAWA dealer for repairs.

 **Displays the remaining memory sampling time for the left bar graph.**

GROUP 1 **ALL**  **DISP**     

Display name or group name
 For all channel display on the trend display, "All" is displayed.

Date and time
 Displayed in yellow while the time is being corrected.

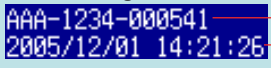
When using the batch function
 **Batch name and the display name are shown alternately.**
Date and time

If the "batch number-lot number" exceeds 20 characters, the "date and time" position is used to display the "batch number-lot number."

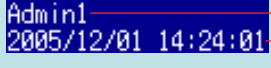
When using the login function
 **Name of the user logged in**
Date and time and the display name are shown alternately.

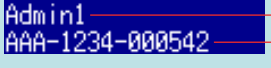
When using the login and batch functions
 **Name of the user logged in**
Batch name, the display name, and date and time are shown alternately.

Alarm icon

 **(Red)** Displayed when any alarm is activated. Blinks when there are alarms that are occurring but have not been acknowledged.

 **(Green)** All alarms have been released after they have occurred, but there are alarms that have not been acknowledged.

Status icon
 The status assigned to the status output (/F1 option) is occurring.

User locked icon (/AS1 option)

 Displayed when the user is locked.

 Keys are locked.

 E-mail transmission is enabled.

Computation icon (/M1 or /PM1 option)

 **White icon:** Computation started

 **Yellow icon:** Computation data dropout occurred

CF card icon

 CF card is being accessed.

 Waiting.

 Light blue icon: CF card in the slot is not recognized. Remove and reset it.

 **CF card error.**
 Carry out the procedure below to reset the CF card icon to normal.

- Remove the CF card, and then reinsert it.
- Replace the CF card with a normal one.
- Format the CF card on the DX (the data on the CF card will be erased).

The green level display indicates the amount of CF card used. If Media FIFO* is not enabled and the free space on the CF card falls below 10%, the level indicator changes to red.

* See section 1.4, in the *DX1000/DX1000N User's Manual*. Media FIFO is a function available on release number 2 or later.

Bar Graph

When event data recording is set to pretrigger, the DX will start recording pretrigger data after you press the START key. "Waiting" appears in the bar graph (release number 3 or later). At this time, the progress bar will turn orange. After the pretrigger time elapses, the length of the bar fixed at that point. However, the relevant data is updated until the trigger condition is met. When the trigger condition is met, the bar turns green, and data is recorded after the data in the pretrigger section.

Trend Display (T-Y)

Measured data is displayed in a waveform. For the operating procedure, see section 4.2.

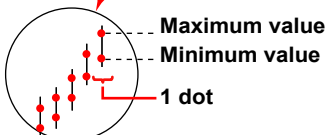
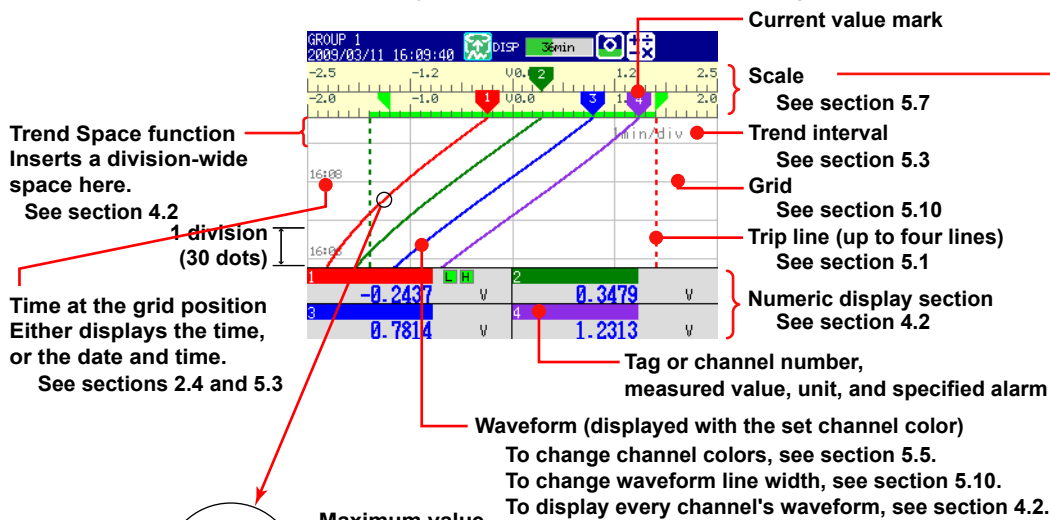

Displays the maximum and minimum values sampled in the time corresponding to one dot.

Display layout See section 5.10

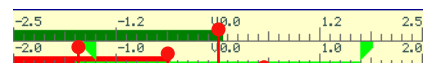

See section 5.8

See section 5.7

See section 5.8

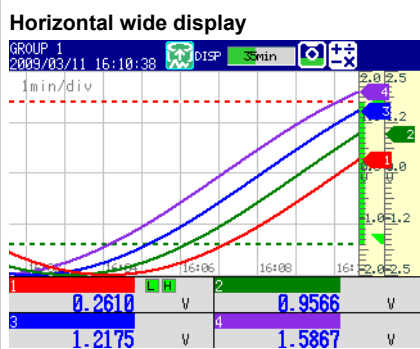
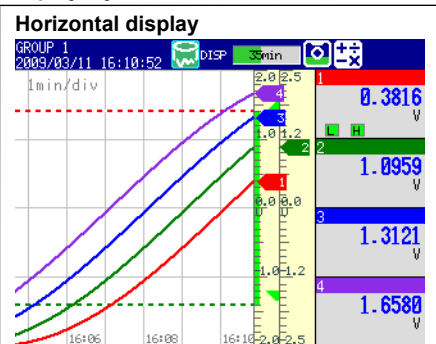

Horizontal split display (displays two groups)
The waveforms of two consecutive groups are displayed. The numeric display sections show the data for the first four channels in their groups.

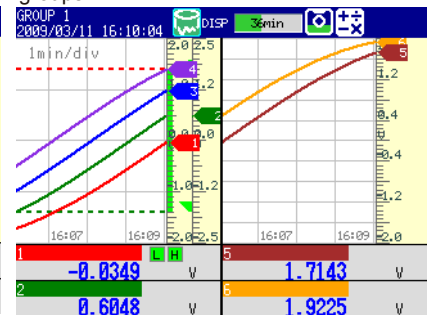

• **Updating of the Waveform**

On the screen, 30 dots along the time axis is represented by a unit called division (see the figure on the previous page). The displayed waveform is updated at an interval corresponding to one dot. This interval is determined by the time corresponding to one division (referred to as the *trend interval*). The relationship between the trend interval and the speed of movement of waveforms on the screen is as follows:

Trend interval (/DIV)	5 s^{*1}	10 s^{*1}	15 s^{*2}	30 s	1 min
Time corresponding to one dot (in seconds)	0.125	0.25	0.5	1	2
Speed of waveform movement (approximation in mm/h)	10000	5000	2500	1250	625
Trend interval (/DIV)	2 min	5 min	10 min	15 min	20 min
Time corresponding to one dot (in seconds)	4	10	20	30	40
Speed of waveform movement (approximation in mm/h)	312	156	78	42	31
Trend interval (/DIV)	30 min	1 h	2 h	4 h	10 h
Time corresponding to one dot (in seconds)	60	120	240	480	1200
Speed of waveform movement (approximation in mm/h)	21	10	5.2	2.6	1.0

*1 40 dots per division. Selectable on the DX1002, DX1002N, DX1004, and DX1004N (release number 3 or later).

*2 Selectable on the DX1006, DX1006N, DX1012, and DX1012N when the scan interval is set to fast sampling mode (release number 3 or later).

Switching the Trend Interval

You can switch from the normal trend interval to the secondary trend interval during memory sampling and vice versa. For the operating procedure, see section 5.3.

• **Writing Messages**

Preset messages

1	Start
2	Material 1
3	
4	

Free message

Set the message when writing the message

Trend display

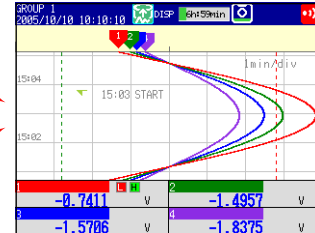

Preset Messages

Preset Messages are recalled and written.

The number of messages that you can use are 100 (message 1 to 10 are shared with free messages). For the operating procedure, see section 5.4

Free Messages

Messages are entered when you need to enter them. The number of messages that you can use are 10. For the operating procedure, see section 5.4.

Automatic Message Writing

- A message is written when the trend interval is switched during memory sampling. For the setting procedure, see section 5.3.
- A message is written when the power recovers from a power failure during memory sampling. For the operating procedure, see section 5.16.
- A message is written when the setting mode setup items are changed during memory sampling (only on DXs with the /AS1 advanced security option).

Message display method

- Except for the vertical display, you can set the direction in which messages are displayed to horizontal or vertical. For the setting procedure, see section 5.10.
- Messages can be displayed consolidated at the upper left of the screen (list display). For the operating procedure, see section 4.2.

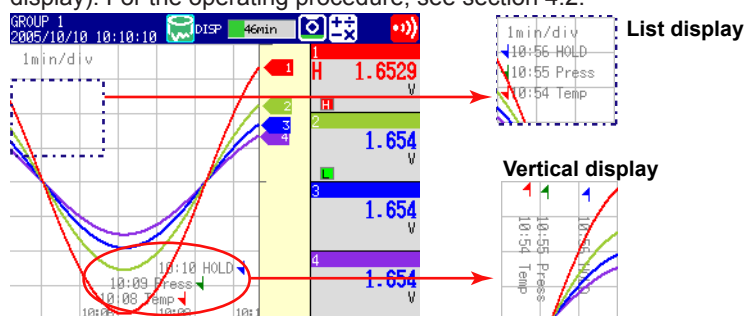

• Zone Display

You can display channels in specified zones. This function can be used to keep the waveforms from overlapping for easier view.

In the example below, channel 1 is displayed in the 0 to 30% zone, channel 2 in the 30 to 60% zone, and channel 3 in the 60 to 100% zone.

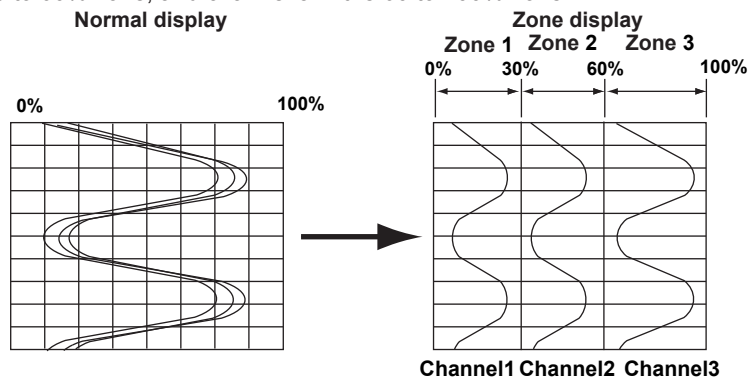

For the setting procedure, see section 5.6.

Auto Zone (Release number 3 or later)

You can divide the waveform display area evenly between each channel in a group. For operating instructions, see section 4.2.

- **Partial Expanded Display**

By compressing a section of the waveform display range, the rest of the section is expanded.

In the example below, 0 V (boundary value) is moved to the 30% position of the display range (new boundary position). The 30% area below the boundary corresponds to “- 6 V to 0 V” and 70% area above the boundary corresponds to “0 V to 6 V.”

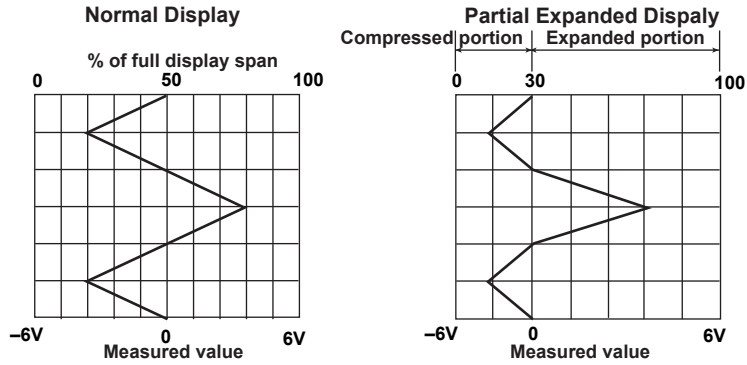

For the setting procedure, see section 5.9.

- **Alarm Indication**

Alarm mark, alarm type, and measured value are displayed as follows according to the alarm status. When you use the alarm annunciator function (release number 3 or later), the alarm mark follows the annunciator sequence.

Alarm	Occurrence Release	When indication is set to non-hold				When indication is set to hold					
		Alarm ACK	Alarm ACK	Alarm ACK	Alarm ACK	Alarm ACK	Alarm ACK	Alarm ACK	Alarm ACK	Alarm ACK	Alarm ACK
Alarm mark	Green	Red	Green	Green	Blinking red	Blinking green	Green	Green	Blinking red	Red	Green
Alarm type	None	Red	None	None	Red	None	None	None	Red	Red	None
Measured value	Blue	Red	Blue	Blue	Red	Blue	Blue	Blue	Red	Red	Blue

Digital Display

Displays the measured data numerically using large numbers. For the operating procedure, see section 4.2.

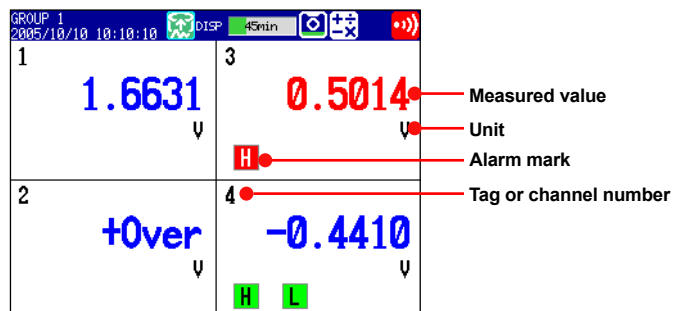

Note

- **Numeric display of measurement channels**

If a measured value of a measurement channel is over range (see below), the measured value is indicated as “+Over” or “-Over.” If a burnout is detected on a channel whose burnout detection function is enabled, the word “Burnout” is indicated. Otherwise, a numeric value is displayed.

- **Over range of measurement channels**

- For DC voltage input, over range occurs when the measured value of the measurement channel exceeds $\pm 5\%$ of the measurable range. For example, the measurable range when the measurement range is 2 V is -2.000 to 2.000 V. If the measured value exceeds 2.200 V, + over range occurs; if the measured value falls below -2.200 V, - over range occurs.
- For thermocouple or RTD input, over range occurs when the measured value exceeds approximately $\pm 10^\circ\text{C}$ of the measurable range. For example, the measurable range when the measurement range is R is 0.0 to 1760.0°C . If the measured value exceeds approximately 1770.0°C , + over range occurs; if the measured value falls below approximately -10.0°C , - over range occurs.
- For channels that are linearly scaled, + over range occurs when the value exceeds 30000 excluding the decimal point; - over range occurs when the value falls below -30000 . However, + over range can be changed to greater than or equal to 105% of the scale width and - over range to less than or equal to -5% of the scale width within ± 30000 . For the setting procedure, see section 3.11.

- **Numeric display of computation channels**

See section 1.8, “Computation and Report Function (/M1 and /PM1 Options)

- **Alarm Indication**

Alarm mark and measured value are displayed as follows according to the alarm status. When you use the alarm annunciator function (release number 3 or later), the alarm mark follows the annunciator sequence.

Alarm	When indication is set to non-hold					When indication is set to hold					
	Occurrence	Release	Alarm ACK	Alarm ACK	Alarm ACK	Alarm ACK	Alarm ACK	Alarm ACK	Alarm ACK	Alarm ACK	Alarm ACK
Alarm mark	Green	Red	Green	Green	Blinking red	Blinking green	Green	Green	Blinking red	Red	Green
Measured value	Blue	Red	Blue	Blue	Red	Blue	Blue	Blue	Red	Red	Blue

Bar Graph Display

Waveform data is displayed in a bar graph. For the operating procedure, see section 4.2.

Vertical

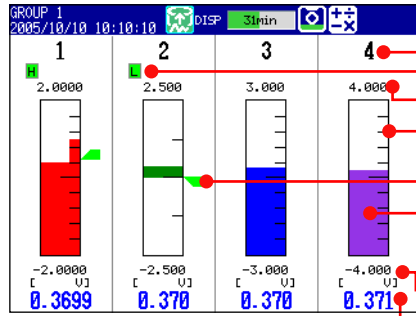

- Tag or channel number
- Alarm mark
- Upper limit
- Scale marks
See section 5.7
- Alarm point mark
- Bar (displayed with the set channel color)
See section 5.11
- Unit of measurement and lower limit
- Measured value

Bar graph base position is set to Center.
See section 5.11

Horizontal See section 5.10

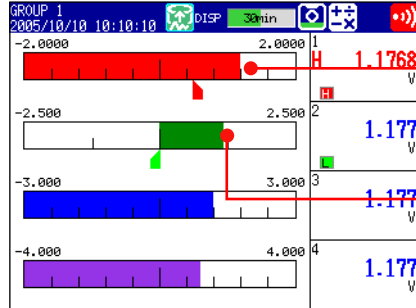

- Bar graph base position is set to Normal, Lower, or Upper.
You can select Lower or Upper on a DX with release number 2 or later.
See section 5.11
- Bar graph base position is set to Center.
See section 5.11

- **Updating of the Bar Graph**

The bar graph is updated at the same interval as numeric values.

- **Alarm Indication**

Alarm mark, alarm point mark, and measured value are displayed as follows according to the alarm status. When you use the alarm annunciator function (release number 3 or later), the alarm marks and alarm point marks follow the annunciator sequence.

Alarm	Occurrence Release	When indication is set to non-hold					When indication is set to hold						
		Green	Red	Green	Green	Blinking red	Alarm ACK	Blinking green	Green	Green	Alarm ACK	Blinking red	Red
Alarm mark	Green	Red	Green	Green	Blinking red	Blinking green	Green	Green	Blinking red	Red	Green		
Point mark	Green	Red	Green	Green	Red	Green	Green	Green	Red	Red	Green		
Measured value	Blue	Red	Blue	Blue	Red	Blue	Blue	Blue	Red	Red	Blue		

Historical Trend Display

The waveform of the past measured data (display or event data) in the internal memory or external storage medium can be displayed. This function is called *Historical trend*.

• Methods of Displaying the Historical Trend

There are four methods to display the historical trend of the measured data in the internal memory.

- Display from the alarm summary. For the operating procedure, see section 4.6.
- Display from the message summary. For the operating procedure, see section 4.7.
- Display from the memory summary. For the operating procedure, see section 4.8.
- Recall from the display selection menu. For the operating procedure, see section 4.3.

Measured data on an external storage medium can also be displayed as historical trend. For the operating procedure, see section 6.8.

• Displayed Contents

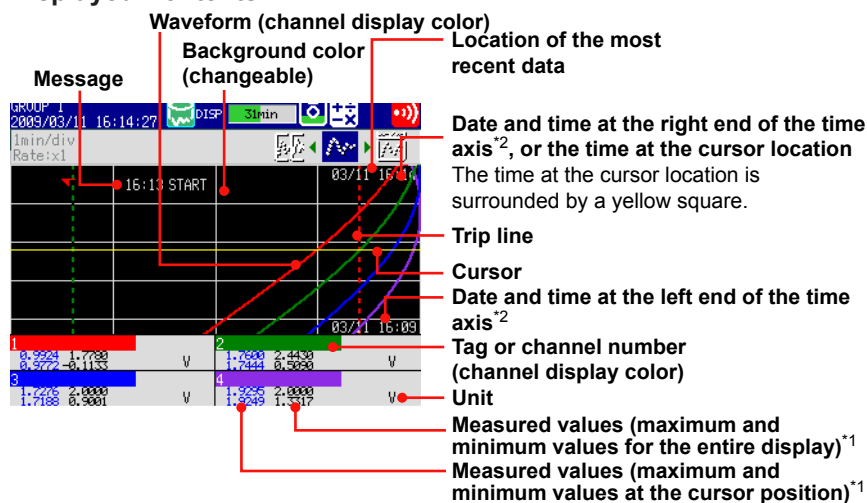

^{*1} You can also view a digital display of just the value at the cursor position (release number 3 or later).

^{*2} You can also display the relative time from the start of recording (release number 3 or later).

Half screen display

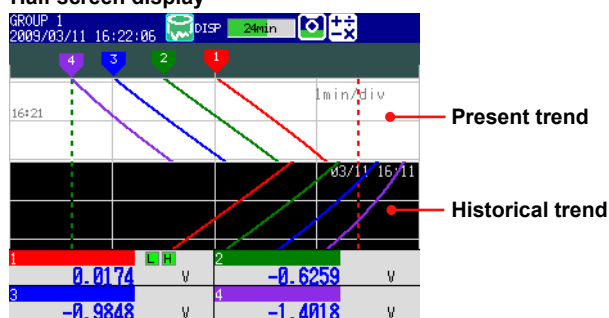

Item	Description
Alarm summary	Displays an alarm summary of the displayed data.
Message summary	Displays a message summary of the displayed data.
Data information	Shows information about the displayed data (file name, sample start time, end time, etc.).

• Added Messages

Added messages can be written. For the operating procedure, see section 5.4.

- **Auto Span Display (Release number 3 or later)**

The DX can automatically adjust the display span of the selected channel. It sets the span based on the maximum and minimum displayed historical data values. This setting is deactivated when you switch to another group.

* Auto span affects channels that are in the same scale position as the selected channel.

When the maximum or minimum values are outside of the set display span

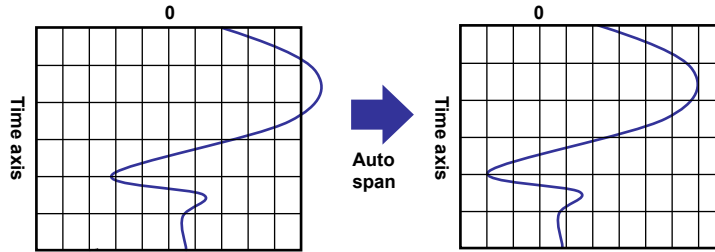

When the maximum or minimum values are within the set display span

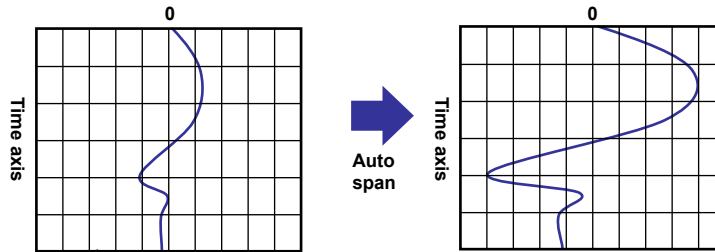

If the maximum or minimum data value falls outside the maximum selectable display span, the DX adjusts the display span to the maximum or minimum possible value. The DX responds in the same way when it encounters overflow data.

- **Top Channel Display (Release number 3 or later)**

Displays the selected channel's historical trend waveform in front of all of the others. This setting is deactivated when you switch to another group.

- **Signature (Only on DXs with the /AS1 advanced security option)**

See the *Advanced Security Function (/AS1) User's Manual, IM 04L41B01-05EN*.

Overview Display

Displays a list of the statuses of all channels.

You can move the cursor to select a channel and display the trend, digital, or bar graph of the group containing the selected channel.

For the operating procedure, see section 4.4.

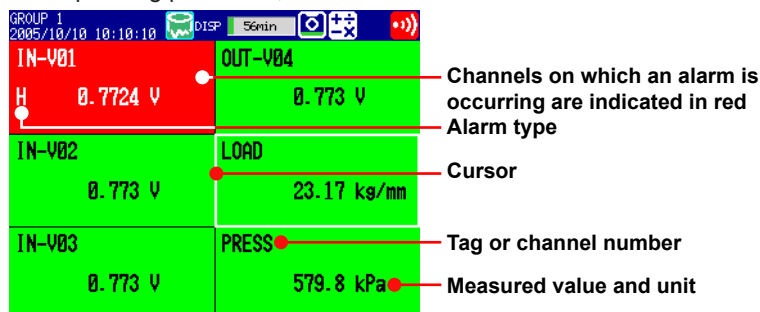

- Alarm Indication**

Channel display area, tag/channel number, alarm type, and measured value are displayed as follows according to the alarm status. When you use the alarm annunciator function (release number 3 or later), the displays of the previously listed items follow the annunciator sequence.

Alarm	When indication is set to non-hold					When indication is set to hold					
	Occurrence	Release				Alarm ACK			Alarm ACK		
Tag/Channel	Black	White	Black	Black	Blinking white	Blinking black	Black	Black	Blinking white	White	Black
Channel area	Green	Red	Green	Green	Red	Green	Green	Green	Red	Red	Green
Alarm type	None	White	None	None	White	None	None	None	White	White	None
Measured value	Black	White	Black	Black	White	Black	Black	Black	White	White	Black

Alarm Summary

Displays a list of the most recent alarms.

- Up to 1000 alarms can be displayed.
- You can select arbitrary alarm information and recall the historical trend of the display data or event data that contains the alarm information.

For the setting procedure, see section 4.6.

	Channel	Type	Alarm Time
▼ OFF	1	1H	2005/10/10 10:07:51
▲ ON	1	1H	2005/10/10 10:07:44
▼ OFF	2	1L	2005/10/10 10:05:38
▲ ON	2	1L	2005/10/10 10:03:45
● ACK			2005/10/10 10:01:38
▲ ON	1	1H	2005/10/10 09:49:02
▼ OFF	2	1L	2005/10/10 09:46:57
▲ ON	2	1L	2005/10/10 09:45:05
▼ OFF	1	1H	2005/10/10 09:42:59
▲ ON	1	1H	2005/10/10 09:40:23
▼ OFF	2	1L	2005/10/10 09:38:19
▲ ON	2	1L	2005/10/10 09:36:26

To the historical trend display

Date and time of alarm occurrence/release

Alarm level number (1, 2, 3, or 4) and type (H, L, h, l, R, r, T, or t)

Channel

▲ ON : Alarm occurrence
(▲ blinks until the AlarmACK operation is carried out if Indicator is set to Hold.)

▼ OFF : Alarm release

● ACK : Alarm output release (when blinking is cleared through the AlarmACK operation)

Cursor (selects an alarm)

The alarm information number displayed on the screen's bottom line and the internal memory alarm information number.

When you use the alarm annunciator function (release number 3 or later), the alarm occurrence mark follows the annunciator sequence. If the alarm sequence is no lock-in (ISA-A-4):

- The alarm occurrence mark does not blink.
- "ACK" is recorded when the alarm is released.

Message Summary

Displays a list of written messages and the time the messages were written.

- Up to 450 messages can be displayed.
- Up to 50 messages that are added to the past data section (added messages) can be displayed.
- You can select arbitrary message information and recall the historical trend of the display data or event data that contains the message.

For the setting procedure, see section 4.7.

Message	Time	Grp
POWER OFF	05/10/10 10:09	1
STOP	05/10/10 10:08	A
DANGER	05/10/10 10:06	A
BATTERY	05/10/10 10:03	2
POWER ON	05/10/10 10:02	A
HIGH VOLTAGE	05/10/10 10:01	A

To the historical trend display

Message Added message (displayed in blue)

Destination group to write the message All groups "A" or a group number, or the second of the date/time when the message was written.

Cursor (selects the message)

Date/Time when the message was written

Number of the message displayed on the bottom line/number of messages in the internal memory

Switching of the Display Items

You can switch between two sets of display contents.

- Message, time when the message was written, and group to which the message was written or second of the time when the message was written
- Message, user name that wrote the message

Memory Summary

Displays the information pertaining to the display data and event data in the internal memory.

- By selecting the display data or event data, the historical trend display can be recalled.
- The number of manual sampled data and report data (/M1 and /PM1 options) in the internal memory is displayed.

For the operating procedure, see section 4.8.

- You can display file information (only on DXs with the /AS1 advanced security option). See the *Advanced Security Function (/AS1) User's Manual, IM 04L41B01-05EN*.

Start Time	End Time	Data	Factor
10-10 10:07:56	10-10 10:08:12	5	Sample Line
10-10 10:03:04	10-10 10:04:48	327	Stop
10-10 10:02:20	10-10 10:02:36	5	Stop
10-10 10:00:24	10-10 10:01:24	16	Stop
10-10 09:58:20	10-10 09:59:32	19	Stop
10-09 20:09:08	10-09 20:25:32	252	Stop
10-09 19:09:08	10-09 20:09:04	900	Auto Save
10-09 18:09:08	10-09 19:09:04	900	Auto Save
10-09 17:09:08	10-09 18:09:04	900	Auto Save
10-09 16:16:52	10-09 17:07:16	737	Stop
10-09 16:01:00	10-09 16:06:04	77	Stop
10-09 09:02:48	10-09 09:43:52	617	Stop

- **Switching of the Display Items**
You can switch between two display methods.
 - Display the start and end times
 - Display the file name

- **Saving the Data**
The data in the internal memory can be saved to a CF card or USB flash memory (/USB1 option).

Report Data (/M1 and /PM1 Options)

Report data residing in the internal memory can be displayed.

For the operating procedure, see section 4.5.

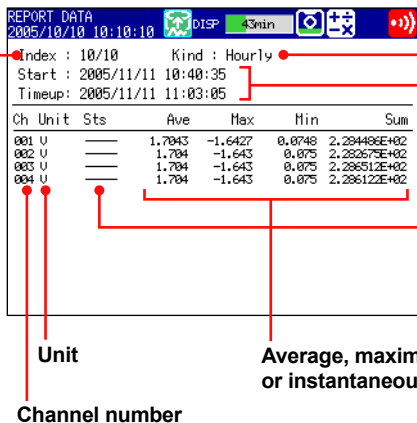

- Report type
- Start: Start date/time
- Timeup: Report date/time
- Report data status
- Indicates that the following occurred between the report interval.
- E: Error data
- O: Over data
- P: Power failure
- C: Time change
- B: Burnout

Unit
Channel number
Average, maximum, minimum, sum, or instantaneous value
Number of the displayed report data/number of report data in the internal memory

Stacked Bar Graph (/M1 and /PM1 options)

You can display the report data (that is stored in the internal memory) of each report group in a stacked bar graph.

For operating instructions, see section 4.10.

For information about report groups, see section 9.5.

Types of Displayed Data

The type of displayed data is determined by the report kind, which is set using the report function.

Report Kind	Displayed Report Data
Hour, H + D	Sums for each hour and sums for the day
Day + Week	Sums for each day and sums for the week
Day, D + M	Sums for each day and sums for the month

Example: Hourly + daily display

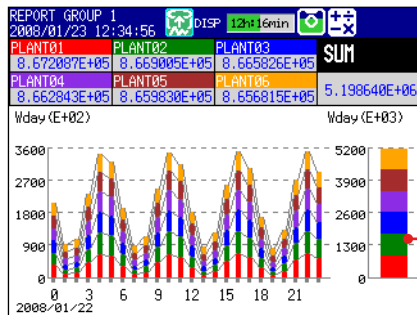

- Daily sums of each channel and the daily sums of all channels of the report group
- If you select a bar graph, the sum of the hour selected with the cursor is displayed.
- Sums for the day (bar graph) of a report group

Hourly report group sums (bar graph)

Display Modes

You can switch the bar graph between single graph and dual graph display.

Single graph display

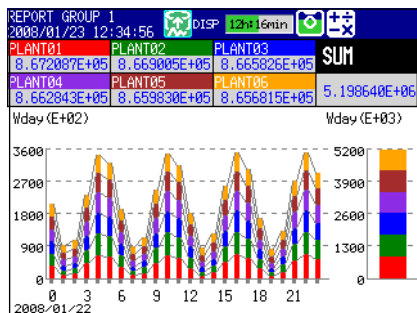

Dual graph display (Shows the data from two consecutive periods)

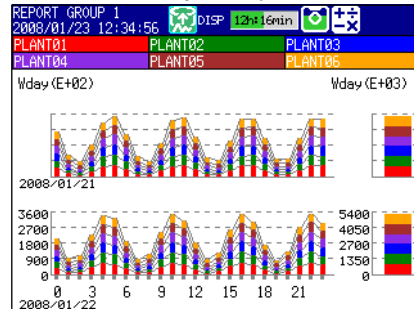

Status Display

The following displays are available.

For the operating procedure, see section 4.5.

- **Relay Status Display**
Displays the status of the alarm output relay and internal switch.
- **Modbus Client Status Display and Modbus Master Status Display**
Displays the command status.
- **Event Level Switch Status (Release number 3 or later)**
Displays the status of the event level switches.

Log Display

Displays various logs (operation log).

For the operating procedure, see section 4.9.

Log Type	Description
Login ^{*1}	Log of login/logout, log of time setting, and log of power failure
Error	Log of error messages
Communications	Log of communication commands
FTP transfer	Log of FTP transfers
WEB	Log of Web operations
E-mail transmission	Log of e-mail transmissions
SNTP	Log of accesses to the SNTP server
DHCP	Log of accesses to the DHCP server
MODBUS	Log of communications using Modbus client or Modbus master
Operation ^{*2}	Log of operations
Change settings ^{*2}	Log of setting changes

*1 Only on DXs without the /AS1 advanced security option

*2 Only on DXs with the /AS1 advanced security option

Other Useful Functions

- **Automatically Reverting to the Specified Display**
Show a preset display when there is no operation for a specific time.
For the setting procedure, see section 5.14.
- **Favorite Key**
Register a frequently used display to the Favorite key and enable the display to be shown through simple operation.
For the setting procedure, see section 5.15.
- **Customizing the Menus**
Change the FUNC key menu that appears when the FUNC key is pressed and the screen menu that appears when the DISP/ENTER key is pressed.
For the setting procedure, see section 5.17.

Setting the Display Conditions of the LCD

The display conditions of the LCD can be configured.

Display Attribute	Setting
Background color of the operation display	The background color of the display can be set to white or black. The default value is White . For the setting procedure, see section 5.12.
Background color of the historical trend screen	You can select white, cream, black, or light gray for the background color of the screen. The default value is Black . For the setting procedure, see section 5.12.
LCD brightness	The brightness of the LCD can be set among eight levels. The default brightness is 2 . For the setting procedure, see section 2.7.
Backlight saver	The lifetime of the LCD backlight can be extended by automatically turning OFF or dimming the light when there is no key operation for a specified amount of time. The display returns to the original brightness with a key operation or an alarm occurrence. By default, the backlight saver is disabled. For the setting procedure, see section 2.7.

1.4 Data Storage Function

This section explains the types of data that the DX can record and how to store them. For information about the data storage function on DXs with the /AS1 advanced security option, see the *Advanced Security Function (/AS1) User's Manual, IM04L41B01-05EN*.

Data Types

The types of data that the DX can record are as follows:

Data Type	Description
Display data	<ul style="list-style-type: none"> Waveform data displayed on the trend display. The measured data is recorded as a specified sampling interval. The sampling interval is specified using the trend interval. The minimum and maximum values among the measured data within the sampling interval are saved. A header string (common to other files) can be written in the file. The display data contains alarm and message information. Data format: Binary (Undisclosed)
Event data	<ul style="list-style-type: none"> Measured data that is recorded at a specified sampling interval. There are two modes. One mode starts recording when a trigger event occurs. The other mode records at all times. A header string (common to other files) can be written in the file. The event data contains alarm and message information. Data format: Binary (Undisclosed)
Manual sampled data	<ul style="list-style-type: none"> Instantaneous value of the measured data when a manual sample operation is executed. A header string (common to other files) can be written in the file. Data format: Text
Report data (/M1 and /PM1 options)	<ul style="list-style-type: none"> Hourly, daily, weekly, and monthly report data. Report data is created at an interval that is determined by the report type (one hour for hourly reports, one day for daily reports, and so on). A header string (common to other files) can be written in the file. Data format: Text The data can be converted to XML spreadsheet data (release numbers 4 and later).
Snapshot data (screen image data)	<ul style="list-style-type: none"> The image data of the DX screen when the snapshot operation is executed. The data can be saved to a CF card. Data format: PNG
Setup data	<ul style="list-style-type: none"> The setup data of the DX. Data format: Binary (Undisclosed)
Custom Display Setup Data	<ul style="list-style-type: none"> The custom display setup data of the DX. Data format: text

• Display data and event data

Display data can be likened to the conventional recording on the chart sheet and are useful for long-term recording. Event data is useful when you wish to record the measured data in detail.

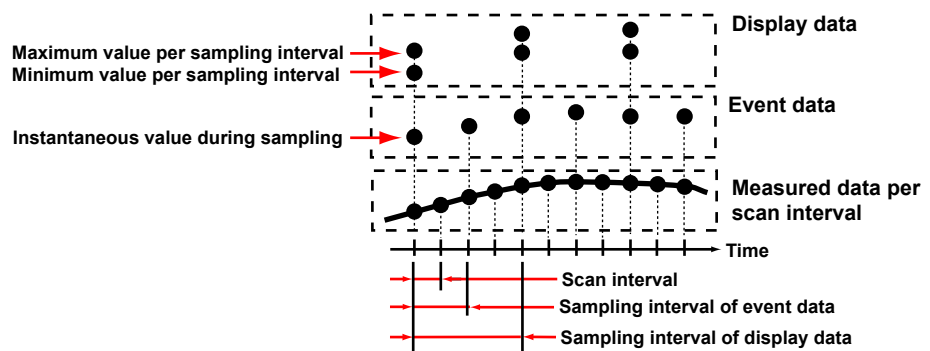

Flow of Data Recording and Storage

Measured data is recorded once to the internal memory and then saved to the external storage medium.

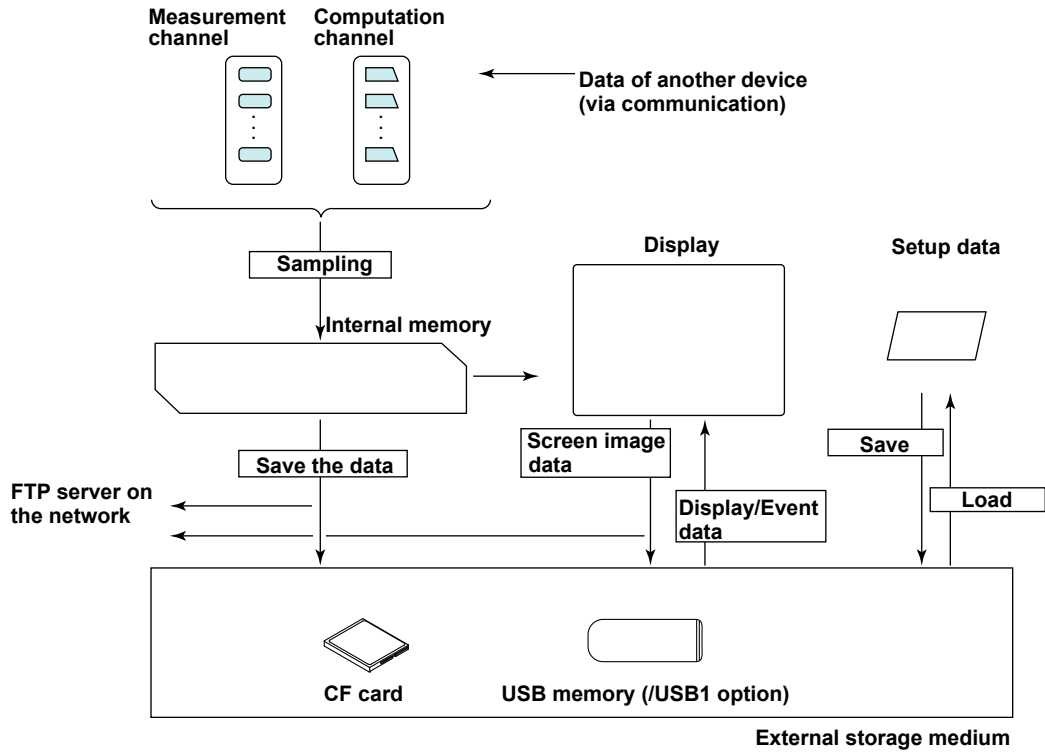

Internal Memory

Display data and event data are held in files in the internal memory. The data area also stored on the external storage medium in files.

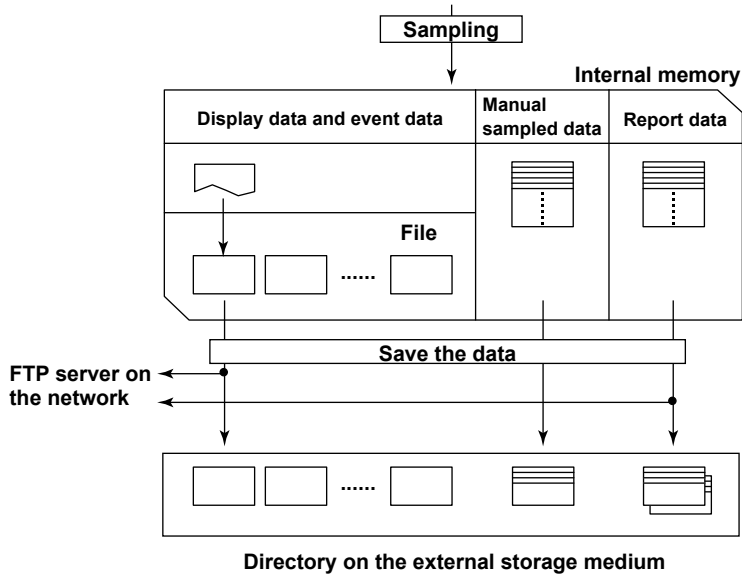

Recording Method of Display Data and Event Data

For the setting procedure, see section 6.1.

- **Types of Data to Be Acquired**

Select display data only, display data and event data, or event data only.

Deciding the Data to Be Recorded

Record the data that suits your application. Refer to the following examples.

Example 1: Continuously record the waveform data as with the conventional chart recorder.

Record the display data.

Example 2: Record waveform data under normal conditions but record details around the point of alarm occurrence when alarms occur.

Continuously record display data and record event data when alarms occur.

Example 3: Only record the most-detailed data at all times.

Record event data by specifying the sampling interval.

Example 4: No need to continuously record data. Record data only when alarms occur.

Record event data only when alarms occur.

- **Internal Memory**

The recorded measured data is divided at a specific time interval and saved to files.

If the internal memory is full or if the number of display data files and event data files exceeds 400, files are overwritten from the oldest file.

- **Recording Conditions of Display Data**

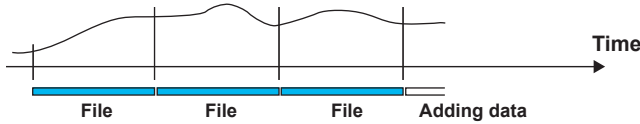
Item	Description
Source channels	Select from measurement channels and computation channels.
Sampling interval	Specify the sampling interval with the trend interval (see the table below). You cannot specify a sampling interval that is faster than the scan interval.
File creation	Files are created at the specified file save interval. <div style="text-align: center;">  </div> <ul style="list-style-type: none"> Files are also created in the following cases. <ul style="list-style-type: none"> • When a file is created manually. • When the memory sampling is stopped. • When file creation is executed with the event action function. • After recovering from a power failure.
Memory start/stop	Press the START key to start recording (memory start) and the STOP key to stop the recording (memory stop).

Trend interval and the sampling interval of display data

Trend interval	5 s^{*1}	10 s^{*1}	15 s^{*2}	30 s	1 min
Sample rate	125 ms	250 ms	500 ms	1 s	2 s
Trend interval	2 min	5 min	10 min	15 min	20 min
Sample rate	4 s	10 s	20 s	30 s	40 s
Trend interval	30 min	1 h	2 h	4 h	10 h
Sample rate	1 min	2 min	4 min	8 min	20 min

*1 Selectable on the DX1002, DX1002N, DX1004, and DX1004N (release number 3 or later).

*2 Selectable in fast sampling mode on the DX1006, DX1006N, DX1012, and DX1012N (release number 3 or later).

• Recording Conditions of Event Data

Item	Description
Source channels	Same as the display data.
Sampling interval	Select from the available settings between 25 ms to 30 min. However, you cannot specify an interval that is faster than the scan interval.
File creation	A file is created when the specified data length is reached. Files are also created in the following cases. <ul style="list-style-type: none"> • When a file is created manually. • When the memory sampling is stopped. • When file creation is executed with the event action function. • After recovering from a power failure.
Mode	The available modes are Free (continuously record), Single , and Repeat . The recording operation varies depending on the mode as follows: <p>Free Press the START key to start recording (memory start) and the STOP key to stop the recording (memory stop) .</p>

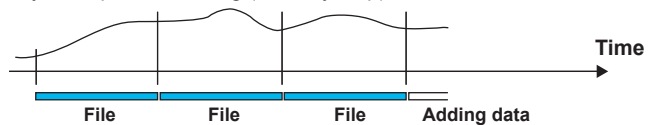

Single

Pressing the START key places the DX in the trigger-wait state. When the trigger condition is met, the DX records data for a specified time (data length) and stops. From this point, the DX does not record even if the trigger condition is met.

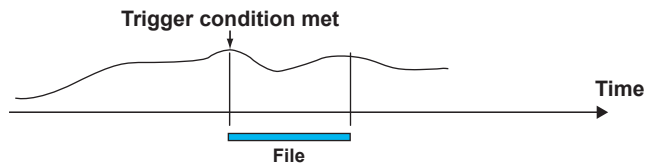

Repeat

Pressing the START key places the DX in the trigger-wait state. When the trigger condition is met, the DX records data for a specified time (data length) and stops. The DX enters the trigger-wait state again and keeps recording the data for a specified time (data length) each time the trigger condition is met. To stop the recording of the event data, press the STOP key.

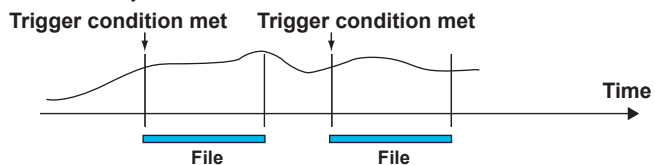

Pretrigger of Event Data

The pretrigger can be specified in trigger mode.

This function is used to save the data before the point where the trigger condition is met as event data. This function is convenient when you wish to record the data before the occurrence of a certain event such as when an alarm occurs.

Specify the pretrigger as a percentage (0, 5, 25, 50, 75, 95, or 100%) of the recording time (data length) of the event data. If set to 0%, the data after the trigger condition is met is recorded.

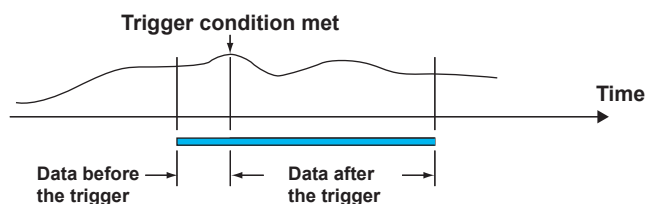

Trigger for Starting the Event Data Recording

When set to trigger mode, you can set various conditions for starting the recording.

Example: Key operation, alarm occurrence, specific time, or remote control

- **Creating Files through Key Operation**

Files can be created using keys.

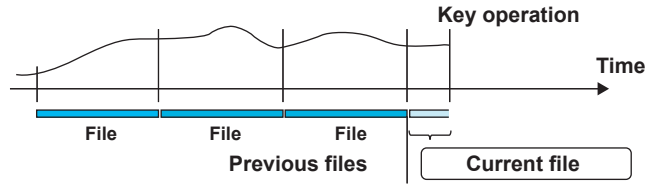

For operating instructions, see “Saving the Display Data or Event Data during Memory Sampling through Key Operation” in section 6.4.

Manual Sampled Data

Manual sampled data is recorded to the internal memory. When the number of manual sampled data exceeds 400, the data is overwritten from the oldest data.

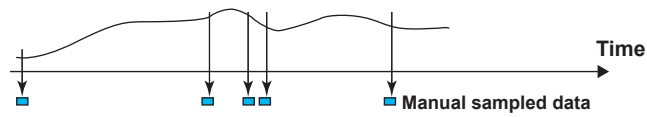

Report Data

Report data is recorded to the internal memory. When the number of report data exceeds 100, the data is overwritten from the oldest data.

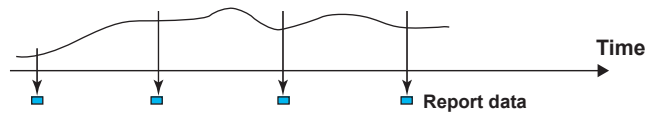

Saving Data to the External Storage Medium

For the setting and operating procedure, see sections 6.2 and 6.4 respectively.

- **Type of External Storage Medium**

- CF card (32 MB or more)
- USB flash memory (/USB1 option)

- **Auto Save**

Have the CF card inserted in the slot at all times. The data in the internal memory is automatically saved to the CF card.

Auto Save Timing

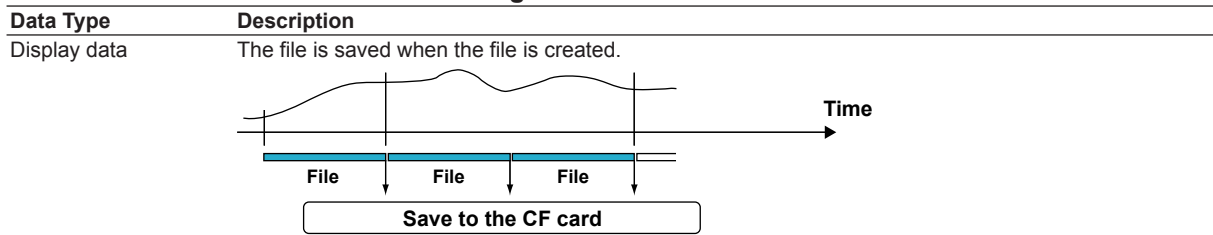

Event data	Same as the display data.
Manual sampled data	The first time manual sample is executed, a manual sampled data file is created on the CF card. The data is appended to this file for each subsequent manual sample operation. A new file is created after manual sampled data has been stored 100 times. For operating instructions, see section 6.5.

Report data	The first time report data is generated, a report data file is created on the CF card and report data is stored. The report data is appended to this file every time of report.
-------------	---

Dividing of the report files

The appending of the report data to the file is stopped at a specified time, and subsequent reports are saved to a new file. The file is divided in the unit shown in the table below. Also, when recording is stopped (memory stop), all report files are divided.

Report Template (Release numbers 4 and later)

When the report file is divided, a report data file of the format specified by the XML spreadsheet template is created. This function is disabled in the cases listed under "Seprt2" below.

For the setting procedure, see section 9.5.

Report Type	Report File		
	File for Each Type	One File	Seprt2 ^{*1}
Hourly report	<input type="checkbox"/> hourly reports of a day	<input type="checkbox"/> hourly reports of a day	<input type="checkbox"/> hourly reports for a day
Daily report	<input type="checkbox"/> daily reports for a month	<input type="checkbox"/> daily reports for a month	<input type="checkbox"/> daily reports for a month
Hourly and daily reports	<input type="checkbox"/> a file for each daily report <input type="checkbox"/> hourly reports of a day	<input type="checkbox"/> hourly reports for a day and a daily report	<input type="checkbox"/> daily reports for a month <input type="checkbox"/> hourly reports for a day
Daily and weekly reports	<input type="checkbox"/> a file for each weekly report <input type="checkbox"/> daily reports for a week	<input type="checkbox"/> daily reports for a week and a weekly report	<input type="checkbox"/> weekly report (not divided) ^{*2} <input type="checkbox"/> daily reports for a week
Daily and monthly reports	<input type="checkbox"/> a file for each monthly report <input type="checkbox"/> daily reports for a month	<input type="checkbox"/> daily reports for a month and a monthly report	<input type="checkbox"/> monthly report (not divided) ^{*2} <input type="checkbox"/> daily reports for a month

*1 Available for release numbers 4 and later.

*2 When media FIFO is enabled, files are divided at approximately every 100 KB.

Save Destination

CF card.

Data Save Destination Directory

You can set the data save destination directory name (DATA0 by default). The specified directory is created on the CF card, and the data is saved in the directory.

Save Operation (If Media FIFO Is Disabled)

The data in the internal memory can be saved only if there is sufficient free space on the CF card. Replace the CF card and save the data before the data in the internal memory is overwritten.

Save Operation (Constantly Retaining the Most Recent Data Files Using Media FIFO) (Release Number 2 or Later)

When saving the data files automatically, you can save the data so that the most recent data files are constantly retained in the CF card. This method allow you to use the DX continuously without having to replace the CF card.

• **Operation**

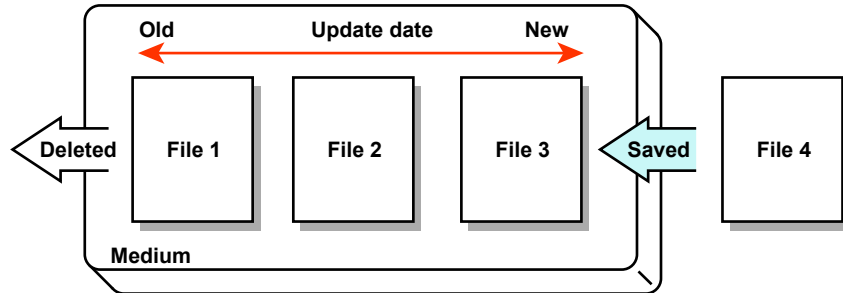

If not enough free space is available when saving a new data file to the CF card, files are deleted in order from the oldest data update date/time to save the new file. This operation is referred to as FIFO (First In First Out).

- The FIFO operation is carried out only when saving the following files automatically. It is not carried out when saving files to the save destination directory using another method. Display data files, event data files, report data files, manual sample data files, and snapshot data files
- Files that are deleted
All the files in the save destination directory are applicable to be deleted. However, the following files are excluded. Hidden files, read-only files, files in the subdirectory within the save destination directory
- The most recent 1000 files are retained. If the number of files in the save destination directory exceeds 1000, the number of files is held at 1000 by deleting old files even if there is enough free space.
- f there are more than 1000 files already in the save destination directory, one or more files are always deleted before saving the new file. The number of files is not kept within 1000 in this case.

• **Manual Save (Collectively Storing Unsaved Data)**

Unsaved data in the internal memory is stored in unit of files to the external storage medium when an external storage medium is inserted and a given operation is carried out.

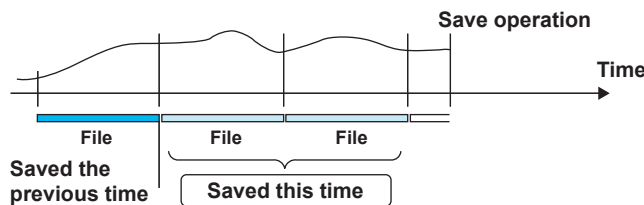

When using manual save, it is important that you save the data in the internal memory to the external storage medium before the data is overwritten. Determine the usage condition of the internal memory and save the data to the external storage medium at appropriate times.

Save Destination

You can select a CF card or USB flash memory (/USB1 option).

Data Save Destination Directory

You can set the data save destination directory name (DATA0 by default).

• File Name

You can select the file name configuration from three types.

Structure	Description	
Date	Display data Event data Manual sampled data Snapshot data	<div style="border: 1px solid black; padding: 2px;"> 7-digit Specified string Date Extension </div> Ex.: 000123_AAAAAAAAAAA050928_174633.DAD
	Report data	<div style="border: 1px solid black; padding: 2px;"> 7-digit Specified string Date Type Extension </div> Ex.: 000123_AAAAAAAAAAA050928_174633HD.DAR
Serial	Display data Event data Manual sampled data Snapshot data	<div style="border: 1px solid black; padding: 2px;"> 7-digit Specified string Extension </div> Ex.: 000123_AAAAAAAAAAA.DAD
	Report data	<div style="border: 1px solid black; padding: 2px;"> 7-digit Specified string Type Extension </div> Ex.: 000123_AAAAAAAAAAA0HD.DAR
Batch name	Display data Event data	<div style="border: 1px solid black; padding: 2px;"> 7-digit Batch name Extension </div> Ex.: 000123_BBBBBBBBBBBBBBBBBBBB.DAD
	Report data	<div style="border: 1px solid black; padding: 2px;"> 7-digit Date Type Extension </div> Ex.: 000123_050928_174633HD.DAR
	Manual sampled data Snapshot data	<div style="border: 1px solid black; padding: 2px;"> 7-digit Date Extension </div> Ex.: 000123_050928_174633.DAM

Item	Description	
7-digit	Consists of a 6-digit number and 1-character delimiter.	
	6-digit number	A sequence number in the order of occurrence. The number ranges from 000001 to 999999. If the number reaches 999999, it returns to 000000.
	1-character delimiter	Starts with '_' and takes on the following values: A to Z and 0 to 9. If a file with the same name exists in the specified directory, the file is saved by changing the delimiter to prevent overwriting. Example: If a file named "000123_AAAAAAAAAAA.DAD" already exists, the file is saved to the name "000123AAAAAAAAAAAA.DAD."
Date	YYMMDD_hhmmss	YY: Year (lower two digits), MM: Month, DD: Day hh: Hour, mm: Minute, ss: Second
Specified string	AAAAAAAAA***A	Up to 16 alphanumeric characters can be used
Batch name	BBBBBBBBBBB***B	Up to 40 alphanumeric characters can be used
Type	H_, D_, W_, M_, HD, DW, DM	Report data type H_: Hourly, D_: Daily, W_: Weekly, M_: Monthly, HD: Hourly and daily, DW: Daily and weekly, DM: Daily and monthly
Extension	Display data :DAD Event data :DAE Manual sampled data :DAM	Report data :DAR Report data :xml (Report template; release numbers 4 and later) Snapshot data :PNG

Note

Differences from the File Names up to Now

- The "ID" item at the end of the file name is deleted and its functionality is included in the "Separator" of the 7-digit sequence.

Example

DXs before release number 2: 000123_AAAAAAAAAAA050928_1746330.DAD

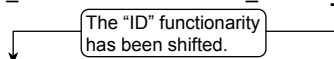

DXs with release number 2 or later: 000123_AAAAAAAAAAA050928_174633.DAD

- The sequence section of the display data and event data file names is changed to 7 digits, and the "ID" function is included in the "Separator" when using the "Batch name."

1.4 Data Storage Function

File Names on DXs before Release Number 2

The table below shows the file name that is assigned when the measured data is saved to the CF card.

Structure	Description	
Date	Display data Event data Manual sampled data Snapshot data	<div style="border: 1px solid black; padding: 2px; display: inline-block;"> 7-digit Specified string Date ID Extension </div> Ex.: 000123_AAAAAAAAAAAA050928_1746330.DAD
	Report data	<div style="border: 1px solid black; padding: 2px; display: inline-block;"> 7-digit Specified string Date Type ID Extension </div> Ex.: 000123_AAAAAAAAAAAA050928_174633DH0.DAR
Serial	Display data Event data Manual sampled data Snapshot data	<div style="border: 1px solid black; padding: 2px; display: inline-block;"> 7-digit Specified string ID Extension </div> Ex.: 000123_AAAAAAAAAAAA0.DAD
	Report data	<div style="border: 1px solid black; padding: 2px; display: inline-block;"> 7-digit Specified string Type ID Extension </div> Ex.: 000123_AAAAAAAAAAAHD0.DAR
Batch name	Display data Event data	<div style="border: 1px solid black; padding: 2px; display: inline-block;"> 3-digit Batch name ID Extension </div> Ex.: 123BBBBBBBBBBBBBBBBBBBBB0.DAD
	Report data	<div style="border: 1px solid black; padding: 2px; display: inline-block;"> 7-digit Date Type ID Extension </div> Ex.: 000123_050928_174633HD0.DAR
	Manual sampled data Snapshot data	<div style="border: 1px solid black; padding: 2px; display: inline-block;"> 7-digit Date ID Extension </div> Ex.: 000123_050928_1746330.DAM

Item	Description	
Date	YYMMDD_hhmmss	Same as release number 2 and later.
7-digit sequence	000001 to 999999	Consists of a 6-digit number and an underscore as a separator. A sequence number in the order of occurrence.
3-digit sequence	001 to 999	A sequence number in the order of occurrence.
Type	H_, D_, W_, M_, HD, DW, DM	Report data type Same as release number 2 and later.
ID	0 to 9, A to Z	When a file with the same name exists in the specified directory, the file is saved by changing the ID character to prevent overwriting. Example: If a file named "000123_AAAAA050907_1036480.DAD" already exists, the file is saved to the name "000123_AAAAA050907_1036481.DAD."
Extension	Except for xml, same as release numbers 2 and later.	

- **Saving Data through Key Operation**

You can carry out the following data save operations regardless of whether auto save or manual save is used.

Data Storage	Description
All save	Collectively saves all the data in the internal memory.
Selective save	Saves the specified display data or event data file.
Manual sampled data save	Collectively saves all the manual sampled data in the internal memory.
Report data save	Collectively saves all the report data in the internal memory.

Save Destination

You can select a CF card or USB flash memory (/USB1 option).

Data Save Destination Directory

Creates a directory with the name of the data save destination directory name with the date/time added and saves the data.

Directory name: "Specified string"_YYMMDD_HHMMSS

Example: If the data is saved at 17 hours 6 minutes 42 seconds on September 30, 2005, the data is saved to a directory named "DATA0_050930_170642." "DATA0" is the specified string.

Note

The number of directories that you can create on the external storage medium varies depending on the length of the directory names. If the length of the "specified string" is 5 characters, approximately 170 directories can be created. If it is 20 characters, approximately 120 directories can be created. An error occurs, if you try to create directories exceeding this limit.

Other Types of Data That Can Be Stored

- **Setup Data**

The setup data of the DX is saved to a CF card or USB flash memory (/USB1 option). The setup data is saved to the root directory.

Name of the setup data file	Specified . PDL Example: ABCD10005.PDL
-----------------------------	---

- **Snapshot Data**

The screen that the DX displays is saved to a CF card in PNG format. The data is saved to the same directory as the display data and event data. For the file name, see the previous page.

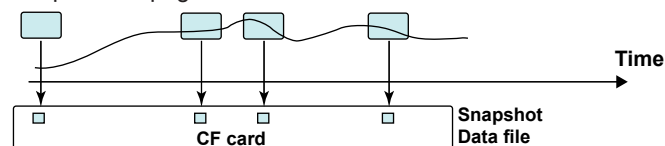

- **Custom Display Setup Data**

See the *Custom Display User's Manual, IM04L41B01-04E*.

Saving Data via the Ethernet Network

Display data, event data, report data (/M1 or /PM1 option), and screen image data (snapshot data) can be automatically transferred and saved to an FTP server via the Ethernet network by using the FTP client function. Conversely, the DX can function as an FTP server. The DX can be accessed from a PC and the data files in the internal memory or the external storage medium can be retrieved to be stored on the PC.

See the *Communication Interface User's Manual, IM 04L41B01-17E*.

1.5 Batch Function

This section explains the DX batch function. For information about the multi batch function (/BT2 option), see the *Multi Batch (/BT2) User's Manual, IM04L41B01-03E*.

Overview

You can add batch information to the display data and event data files. The files can be managed using the batch information.

For the setting and operating procedure, see section 6.3.

Batch Information

- **Batch Number and Lot Number**
Display data and event data files can be identified by their “batch number-lot number” (hereinafter referred to as batch name). The lot number does not have to be specified.
 - Batch number (up to 32 characters).
 - Lot number (up to 8 digits)
- **Automatic Increment of the Lot Number**
The lot number can be automatically incremented when the memory sampling is stopped.
- **Text Field**
You can enter text fields into a file. There are 24 available text fields (release number 3 or later). Each text field consists of the following:
 - Field title (up to 20 characters)
 - Field string (up to 30 characters)

The text field can be shown on the DX screen through key operation.
- **Batch Comment**
Three arbitrary comments can be entered in a file. A single comment can be entered while memory sampling is in progress.
 - Comment 1, Comment 2, and Comment 3 (up to 50 characters each)

Using the Batch Function

See the figure below. For example, enter the operator and administrator in the text field.

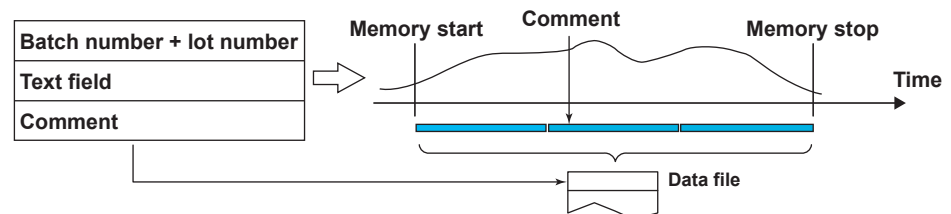

1.6 Event Action and Remote Control Functions (/R1 and /PM1 Options)

A specified action is carried out when an event occurs. This function is called *event action*. The remote control function (/R1 and /PM1 options) allows you to specify actions to be performed when the terminal receives a contact input or an open collector signal. The remote control function is configured using the event action function. For the setting procedure, see section 7.1.

Events

• Events

Select from the following events.

Event	Level/Edge ^{*1}	Description
Remote	Level/Edge	ON/OFF of the remote control input.
Output relay Relay-Off ^{*3}	Level/Edge	Activated/Deactivated condition of the alarm output relay.
Internal switch Switch-Off ^{*3}	Level/Edge	The value, 0 (off) or 1 (on), of the internal switch.
Timer	Edge	Timer timeout.
Match time timer	Edge	When the time matches.
Alarm Alarm-Off ^{*3}	Level/Edge	The state in which any alarm is occurring and the state in which no alarm is occurring.
USER key	Edge	The operation of pressing the USER key.
Event edge switch ^{*2}	Edge	Can be caused by: <ul style="list-style-type: none"> • The Edge Switch soft key in the FUNC key menu. • A dedicated communication command or Modbus communication. • The custom display
Event level switch ^{*2}	Level	You can view the status of the switch in the event level switch status display. Can be caused by: <ul style="list-style-type: none"> • A dedicated communication command or Modbus communication. • The custom display.
EventLevelSwitch-Off ^{*3}		

*1 For a description of level and edge, see “Miscellaneous” in this section.

*2 This function is available for release numbers 3 and later.

*3 This function is available for release numbers 4 and later.

• Output Relay, Internal Switch, Alarm, Event Level Switch

The output relay, internal switch, alarm, and event level switch have two states, state A and state B, which are explained in the table below. In explanations, “Output relay” and similar states are referred to as “ON events,” and “Relay-Off” and similar states are referred to as “OFF events.”

Event	State A	State B
Output relay	Deactivated	Activated
Internal switch	OFF	ON
Alarm	No alarms	At least one alarm
Event level switch	OFF	ON

When Edge Is Selected

An ON event occurs when state A changes to state B. An OFF event occurs when state B changes to state A.

When Level Is Selected

If the action states that correspond to states A and B during an ON event are called “state 2” and “state 1,” respectively, the action states that correspond to states A and B during an OFF event will be state 1 and state 2, respectively.

See “Miscellaneous” and “Level and Edge” in this section.

1.6 Event Action and Remote Control Functions (/R1 and /PM1 Options)

- **Timers**

Four timers are available. The timers are also used with the TLOG computation function (/M1 and /PM1 options).

Timer Type

Absolute timer

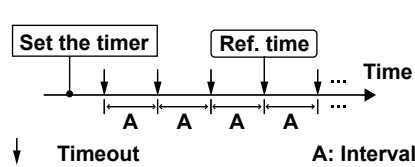

Relative timer

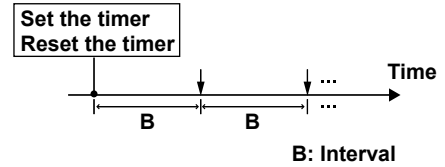

- **Absolute Time Mode**

The timer expires at the times determined by the reference time and the interval. The reference time is set on the hour (00 to 23).

Example: Reference time: 00:00

Interval: 10 min

The timer expires at 0 hour, 0 hour 10 min, 0 hour 20 min, ... 23 hour 40 min, and 23 hour 50 min. For example, if the timer is set at 9 hour 36 min, the timer expires at 09 hour 40 min, 09 hour 50 min, 10 hour, and so on.

- **Relative Time Mode**

The timer is started when the timer is set, and the timer expires every specified interval. In this mode, the timer stops when a power failure occurs.

Example: Interval: 00:15

The timer expires every 15 minutes.

- **Match Time**

You can set the time matching conditions for the four match time timers. Specify the date/time using the method described below. For each condition, you can select whether to use the condition once or continuously. The timers are also used with the TLOG computation function (/M1 and /PM1 options)

Specified Date/Time	Description
Y hour of the X day of the Z year	The condition is met once a year. This function is available for release numbers 3 and later.
Y hour of the X day	The condition is met once a month.
Y hour of the X day of the week	The condition is met once a week.
Y hour	The condition is met once a day.

Action

• Actions

Select from the following actions.

Action	Level/Edge ^{*1}	Description
Memory start/stop	Level	Starts/stops memory sampling.
Memory start	Edge	Starts the memory sampling.
Memory stop	Edge	Stops the memory sampling.
Event trigger ^{*4}	Edge	Applies a trigger for starting the event data recording. This is valid when recording event data in trigger mode. See the next page.
Alarm acknowledge	Edge	Releases the alarm output. This is valid when the use of the alarm ACK operation is enabled.
Computation start/stop ^{*2}	Level	It is used to start/stop the computation.
Computation start ^{*2}	Edge	Starts the computation.
Computation stop ^{*2}	Edge	Stops the computation.
Computation reset ^{*2}	Edge	Resets the computed values on all computation channels.
Save display data	Edge	The display data being recorded is saved to the internal memory as a file. This is the same function as the data save operation using the FUNC key.
Save event data	Edge	The event data being recorded is saved to the internal memory as a file. This is the same function as the data save operation using the FUNC key.
Message	Edge	Writes a message. This action can be executed while memory sampling is in progress.
Snapshot	Edge	Saves the screen image data.
Switch the display rate	Level	Toggles between the trend interval and the secondary trend interval. This action is valid when the DX is configured to use trend interval switching.
Manual sample	Edge	Executes manual sampling.
Reset the relative timer	Edge	Resets the relative timer. The timer restarts from that point.
Switch the display group	Edge	Switches the display group when the trend, digital, or bar graph is displayed.
Flag ^{*2}	Level	The flag is zero for normal conditions and 1 when an event occurs. When the event is an edge operation, the value alternates between 0 and 1 whenever an event occurs. The flag can be written in a calculation expression of a computation channel.
Load the setup ^{*4}	Edge	Loads the setup data file in the root directory of the CF card into the DX and updates the DX settings. See below.
Adjust the time	Edge	Synchronizes the time to the nearest hour. See the next page.
Display comment ^{*3}	Edge	Displays a preset text string (comment text block). For information about how to set comment text blocks, see section 5.18.
Show favorite display ^{*3}	Edge	Shows the display that is registered to the Favorite key. For information about how to register a display to the Favorite key, see section 5.15.
Reset alarm display ^{*3}	Edge	An operation for when you are using a double lock-in sequence (ISA-M) with the alarm annunciator function. Resets the alarm display. For information about annunciator settings, see section 3.12.

*1 For a description of level and edge, see "Miscellaneous" in this section.

*2 This is an option.

*3 This function is available for release numbers 3 and later.

*4 This action is not available on models with the /AS1 advanced security option.

1.6 Event Action and Remote Control Functions (/R1 and /PM1 Options)

Resetting the Relative Timer

If the event is set to output relay, internal switch, match time timer, or alarm, the resetting of the timer is not considered a timeout. (The action is not executed even if the timer is used as an event.)

Loading the Setup

Can be specified as an action only when the event is set to remote control input. Loads the setup data file, LOAD1.PDL, LOAD2.PDL, or LOAD3.PDL, in the root directory of the CF card into the DX and updates the DX settings. You must create a setup file and save it to the CF card in advance.

Event Trigger Operation

When the event is set to output relay, internal switch, or alarm
If the output relay is activated, the internal switch is 1, or the alarm is occurring during memory sampling, the event trigger is always activated. However, the number of times the trigger is activated depends on the event data mode (single or repeat).

Time Adjustment

Time adjustment can be specified as an action only when the event is set to remote control input. The internal clock of the DX is adjusted to the nearest hour through remote control input.

- **Operation When Memory Sampling Is Stopped**

Difference from the Nearest Hour	Operation
00 min 00 s to 01 min to 59 s	Truncates the minutes and seconds. Example: 10 hours 01 min 50 s becomes 10 hours 00 min 00 s.
02 min 00 s to 57 min to 59 s	The time is not changed.
58 min 00 s to 59 min to 59 s	Rounds up the minutes and seconds. Example: 10 hours 59 min 50 s becomes 11 hours 00 min 00 s.

- **Operation during Memory Sampling**

If the time difference between the time the remote control signal is applied and the nearest hour is within the preset time, the time is gradually corrected. Otherwise, the time is corrected immediately. For details, see section 10.1.

On DXs with the /AS1 Advanced Security Option and Release Number 4 or Later

Event	Conditions for Execution
Output relay, internal switch, timer, match time timer, and alarm	When these events occur, their corresponding actions are performed regardless of the user privilege settings and whether users are logged in.
User Key	The same as the key operation itself. In setting mode, memory start cannot be performed.
Event edge switch and event level switch	The same as the key operations themselves. Even in setting mode, memory start cannot be performed.
Remote	When a remote control signal is received, the corresponding action is performed regardless of the user privilege settings and whether users are logged in. In setting mode, memory start cannot be performed.

Miscellaneous

- **Limitations on the Combinations of Events and Actions**

The combinations that are checked in the table below can be used.

Event \ Action	Remote	Output Relay	Internal Switch	Timer	Match Time Timer	Alarm	User Key	Event Edge Switch	Event Level Switch
Alarm ACK	✓			✓	✓		✓	✓	✓
Reset the relative timer	✓	✓	✓		✓	✓	✓	✓	✓
Load the settings	✓								
Adjust the time	✓								
Reset the alarm display	✓						✓	✓	
Other actions	✓	✓	✓	✓	✓	✓	✓	✓	✓

- **Level and Edge**

The combinations of events and actions are summarized in the figure below.

Type	Operation	
Event	Edge	
	OFF event	
Action	Level	
	Edge	

Event Action Example

The following is an example for when the event is Internal switch (Level or Edge) and the action is Memory start/stop (Level) or Manual sample (Edge).

Event Action		Operation	
		Level	Edge
Event (internal switch)	Switch		
	Switch-Off		
Action			
		Memory start/stop	Manual sample

Level and Edge of the Remote Control Input Signal



For contact inputs, the remote signal rises when the contact switches from open to closed and falls when the contact switches from closed to open. For open collector signals, the remote signal rises when the collector signal (voltage level of the remote terminal) goes from high to low and falls when the collector signal goes low to high. You can reverse the above operations (see section 7.3 for details).

1.7 Security Function

This section explains the DX security functions.

For information about the security functions on DXs with the /AS1 advanced security option, see the *Advanced Security Function (/AS1) User's Manual, IM04L41B01-05EN*.

Key Lock Function

Key lock is a function that prohibits key operations. You enter a password to release the key lock.

For the setting procedure, see section 8.1.

Key Lock Items	Description
Keys	The following keys can be locked independently. START key, STOP key, MENU key, USER key, DISP/ENTER key (prohibits switching the operation screen), and Favorite key.
Access to the storage medium	Prohibits all operations listed below. <ul style="list-style-type: none">Manually save the dataLoad the display data and event data filesSave/Load setup data filesList the files on the storage mediumDelete the files on the storage mediumFormat the storage medium
Setup loading	Prevents external storage medium access for the purpose of loading setup files (release number 3 or later).
Function operation	The following FUNC key operations can be locked independently. <ul style="list-style-type: none">[Alarm ACK], [Alarm DisprST]^{*1}[Message], [Free message], [Batch], [Add Message], [Add Free Message] [Text field][Math start],^{*2} [Math stop],^{*2} [Math reset],^{*2} [Math ACK]^{*2}[Save display], [Save event], [Manual sample], [Trigger], [Snap shot], [Timer reset], [Save stop], [Edge Switch],^{*1} [Match T Reset]^{*1}[E-Mail start], [E-Mail stop], [E-Mail test], [FTP test], Operations to [Request] or [Release] network information[SNTP], time setting (operation in the setting mode)[Favorite regist], [Standard display], [Second speed], [Normal speed], [Builder]^{*1}

*1 Available for release numbers 3 and later.

*2 Optional.

Login Function

Only registered users can operate the DX. Access from communication functions can also be limited to users registered here.

For the setting and operating procedure, see sections 8.2 and 8.3 respectively.

- **Login and Logout**

You enter your user name and password to log into the DX in the following cases.

Method of Accessing the DX	Login Required
Keys	<ul style="list-style-type: none"> • When the power is turned ON • When logging in after exiting the basic setting mode • When logging in after logging out
Communication	When accessing the setting/measurement server, FTP server, maintenance/test server, or Web server.

Auto Logout (When Logged in Using Keys)

When logged in using keys, you are automatically logged out when there is no key operation for a specified time. If you are automatically logged out from the setting mode, the setting changes are cancelled. You are not automatically logged out during basic setting mode.

Operations That Can Be Carried Out When Logged Out

When logged out, you can switch the operation screen using the DISP/ENTER key, arrow keys and Favorite key.

- **User Levels**

A user can be an “administrator” or a “user.”

Administrator

Administrators can perform all operations on the DX. At least one administrator must be registered to use the login function.

Item	Description
Number of users that can be registered	5
Range of operations	All operations.
Login method	Select key operation, via communication, or Web server login.
ID information	User name and password

User

Item	Description														
Number of users that can be registered	30														
Range of operations	<table border="1"> <thead> <tr> <th colspan="2">Key operations</th> <th>Limitation</th> </tr> </thead> <tbody> <tr> <td colspan="2">Basic setting mode</td> <td>Not allowed</td> </tr> <tr> <td rowspan="2">Setting mode</td> <td>Customize menus</td> <td>Not allowed</td> </tr> <tr> <td>Other</td> <td>Specified by user privileges</td> </tr> <tr> <td>Operation mode</td> <td>Key operation</td> <td>Specified by user privileges</td> </tr> </tbody> </table>	Key operations		Limitation	Basic setting mode		Not allowed	Setting mode	Customize menus	Not allowed	Other	Specified by user privileges	Operation mode	Key operation	Specified by user privileges
Key operations		Limitation													
Basic setting mode		Not allowed													
Setting mode	Customize menus	Not allowed													
	Other	Specified by user privileges													
Operation mode	Key operation	Specified by user privileges													

- **User privileges**

You can set operation privileges for each user. The privileges are the same as with the key lock function.

Operations via communication

See the *Communications Interface User's Manual*.

Login method	Select key operation, via communication, or Web server login.
ID information	User name and password

1.8 Computation and Report Function (/M1 and /PM1 Options)

Computation Function

Equations can be defined in computation channels by using the measured data or computed data as variables. The result of the computation can be displayed or stored. For the setting procedure, see section 9.1.

- Channels Dedicated to Computations**

Model	Number of Channels	Channel Numbers
DX1002, DX1004, DX1002N, DX1004N	12	101 to 112
DX1006, DX1012, DX1006N, DX1012N	24	101 to 124

- Computation Types**

In the table below, [001] represents the measured value of channel 001.

Type	Example	Description of the Example	
Four arithmetic operation	001+002	Determines the sum of [001] and [002].	
	001-002	Determines the difference between [001] and [002].	
	001*002	Determines the product of [001] and [002].	
	001/002	Divides [001] by [002].	
Power	001**002	Determines [001] to the power of [002]. $y = X^n$	
Square root	SQR(001)	Determines the square root of [001].	
Absolute value	ABS(001)	Determines the absolute value of [001].	
Common logarithm	LOG(001)	Determines the common logarithm of [001]. $y = \log_{10}x$	
Natural logarithm	LN(001)	Determines the natural logarithm of [001]. $y = \ln x$	
Exponent	EXP(001)	Determines e to the power of [001]. $y = e^x$	
	Relational computation	001.LT.002	The result is 1 when [001] is less than [002] or 0 otherwise.
		001.LE.002	The result is 1 when [001] is less than equal to [002] or 0 otherwise.
		001.GT.002	The result is 1 when [001] is greater than [002] or 0 otherwise.
		001.GE.002	The result is 1 when [001] is greater than equal to [002] or 0 otherwise.
		001.EQ.002	The result is 1 when [001] is equal to [002] or 0 otherwise.
001.NE.002		The result is 1 when [001] is not equal to [002] or 0 otherwise.	
Logical computation	001AND002	The result is 1 when [001] and [002] are nonzero or 0 otherwise.	
	001OR002	The result is 1 when [001] or [002] or both are nonzero or 0 otherwise.	
	001XOR002	The result is 0 when [001] and [002] are nonzero or 1 otherwise.	
	NOT001	The result is 1 when [001] is zero or 0 otherwise.	
TLOG computation*	TLOG.SUM(001)	Determines the sum of [001].	
	TLOG.MAX(001)	Determines the maximum value of [001].	
	TLOG.MIN(001)	Determines the minimum value of [001].	
	TLOG.AVE(001)	Determines the average value of [001].	
	TLOG.P-P(001)	Determines the difference between the maximum value and minimum value of [001].	

* See "Usage of TLOG Computations" in this section.

1.8 Computation and Report Function (/M1 and /PM1 Options)

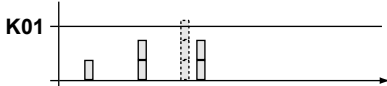
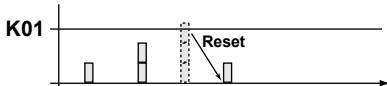
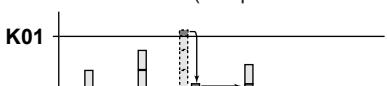
Type	Example	Description of the Example
CLOG computation	CLOG.SUM(001.002.003)	Determines the sum of [001], [002], and [003].
	CLOG.MAX(001.002.003)	Determines the maximum value among [001], [002], and [003].
	CLOG.MIN(001.002.003)	Determines the minimum value among [001], [002], and [003].
	CLOG.AVE(001.002.003)	Determines the average value of [001], [002], and [003].
	CLOG.P-P(001.002.003)	Determines the difference between the maximum value and the minimum value among [001], [002], and [003].
Special computation	PRE(001)	Determines the previous value of [001].
	101=HOLD(001.GT.K01):TLOG.SUM(001)	Under normal conditions, TLOG.SUM(001) is carried out to derive the computed value. When [001] exceeds K01, the previous computed value is held.
Description	HOLD(a):b	When a is zero, b is carried out to derive the computed value. Otherwise, the previous computed value is held.
		
	RESET(101.GT.K01):TLOG.SUM(001)	Under normal conditions, TLOG.SUM(001) is carried out to derive the computed value. When [101] exceeds K01, the previous computed value is reset, and TLOG.SUM(001) is carried out.
Description	RESET(a):b	When a is zero, b is carried out to derive the computed value. Otherwise, the previous computed value is reset, and b is carried out to derive the computed value.
		
	CARRY(K01):TLOG.SUM(001)	Under normal conditions, TLOG.SUM(001) is carried out to derive the computed value. When the computed value is greater than or equal to K01, the computed result is the excess (computed value - K01).
Description	CARRY(a):b	Only TLOG.SUM can be specified for b. If the computed value X of b is less than a, the computed result is X. If X is greater than or equal to a, the computed result is the excess (X - a).
		
Conditional equation	[001.GT.K01?001:001+002]	When [001] is greater than K01, the computed value is set to the value of [001]. Otherwise, the computed value is set to the value of [001] + [002].
Description	[a?b:c]	If the computed result of a is nonzero, b is carried out. Otherwise, c is carried out.

1.8 Computation and Report Function (/M1 and /PM1 Options)

- **Data That Can Be Used in Equations**

The data listed below can be used.

Data	Notation	Description
Measurement channel data	001, etc.	Specify the computed data using a channel number.
Computation Channel data ^{*1}	101, etc.	Specify the computed data using a channel number.
Constant	K01 to K60	A value.
Communication input data	C01 to C24	Data set through communications.
Status of the remote control input ^{*1}	D01 to D08 ^{*2}	The value is 1 when the remote control input is ON or 0 when it is OFF.
Pulse input ^{*1}	P01 to P08 ^{*2} Q01 to Q08 ^{*2}	Counts the number of pulses per scan interval. Counts the number of pulses per second.
Internal switch status	S01 to S30	1 or 0.
Alarm output relay status ^{*1}	I01 to I06	The value is 1 when activated or 0 when deactivated.
Flag ^{*1}	F01 to F08	1 or 0. Set the flag using the event action function (see section 1.6).
Recording (memory sampling) status	M01 to M06	The value is 1 when recording is taking place and 0 when recording is stopped. When the multi batch function is not being used (release number 3 or later; /BT2 option), M01 indicates the recording (memory sampling) status. When the multi batch function is being used, M01 to M06 indicate the recording (memory sampling) statuses of each batch. The recording status of an inactive batch group is 0. This function is available for release numbers 3 and later.

*1 An option.

*2 Values such as 01 are terminal numbers.

Only the data that are checked in the table below can be used in TLOG, CLOG, and PRE.

Data	Meas. Channel	Comp. Channel	Constant	Comm. Input	Remote	Pulse	Internal Switch	Relay	Flag	Record status
Comp. Type										
TLOG	✓	✓	✓	✓	✓	✓	✓	✓	✓	✓
CLOG	✓	✓	✓	✓	✓	✓	✓	✓	✓	✓
PRE	✓	✓	✓	✓	✓	✓	✓	✓	✓	✓
Other computations	✓	✓	✓	✓	✓	✓	✓	✓	✓	✓

Example: TLOG.SUM(S01), CLOG.AVE(001.002.K01), and PRE(S01) are not allowed.

- **Processing Order of Computation**

Computation is processed in order from the smallest event action number for each scan interval.

Example: If you specify $102 = 101 + 103$, the value of the previous scan interval is used for the 103 value.

- **Handing of the Unit in Computations**

In computations, measured values are handled as values without units. For example, if the measured data from channel 001 is 20 mV and the measured data from channel 002 is 20 V, the computed result of $001 + 002$ is 40.

- **Displaying the Computed Data**

The computed data is displayed by setting a measurement span for each computation channel. Computation channels can be displayed on various operation screens in the same fashion as the measurement channels.

For the setting procedure, see section 9.3.

- **Alarm**

Up to 4 alarms can be assigned to each computation channel. The alarm types are high limit alarm (H), low limit alarm (L), delay high limit alarm (T), and delay low limit alarm (t).

- **Saving Computed Data**

As with the measured data, the computed data can be saved to display data, event data, manual sampled data, and report data.

- **Computation Data Dropout**

A computation data dropout occurs if the computation is not completed within the scan interval. For the operating procedure, see section 9.4.

- The computation icon in the status display section turns yellow.
- When a computation data dropout occurs, the computed data of the scan interval in which the dropout occurred is set to the data immediately before the dropout.
- If computation data dropout occurs frequently, lessen the load on the CPU by reducing the number of computation channels or setting a longer scan interval.

- **Numeric Display and Recording**

The range of displayed values of computed data is from -9999999 to 99999999 excluding the decimal point. The decimal place corresponds to the decimal place of the lower limit span of the computation channel. On the numeric display, values are displayed if the computed result is within the above range regardless of the upper and lower limits of span. The following table indicates special displays.

Display/Recording	Computed Data Status
+Over	<ul style="list-style-type: none"> • +Display over: When the computed result exceeds 99999999 • +Computation over: When the value exceeds approximately $1.79E+308$ in the middle of the computation • When a computation error* occurs (select +Over or –Over.)
–Over	<ul style="list-style-type: none"> • –Display over: When the computed result is less than -99999999 • –Computation over: When the value is less than approximately $-1.79E+308$ in the middle of the computation • When a computation error* occurs (select +Over or –Over.)

* Computation error occurs when the following computation is carried out.

- $X/0$, $SQR(-X)$, or $LOG(-X)$
- If a channel number set to skip or Off is used in the equation

- **Rolling Average**

The rolling average of the computed result of the equation specified for the computation channel is determined, and the result is the computed data for that channel. The number of samples and the sampling interval can be specified for each computation channel. The rolling average is applied over the time corresponding to “the number of data samples \times the sampling interval.” The maximum sampling interval is 1 hour, and the maximum number of samples is 1500.

- **Starting the Computation**

You can configure the DX to start the computation when you press the START key.

- **Usage of TLOG Computations**

TLOG computation determines the sum, maximum, minimum, average, or the difference between the maximum and minimum of a specific channel for each interval determined by a timer.

Timers That Are Used

The timer that is used is assigned to each channel.

Unit of Sum Computation

Set the sum scale when using sum computation (TLOG.SUM).
Select Off, /s, /min, or /h. For details, see page 1-49.

1.8 Computation and Report Function (/M1 and /PM1 Options)

Resetting the TLOG Computed Value

You can select whether to reset the TLOG computed value at each interval. The figure below illustrates the reset operation for sum computation (TLOG.SUM).

Example: Result of the TLOG.SUM computation

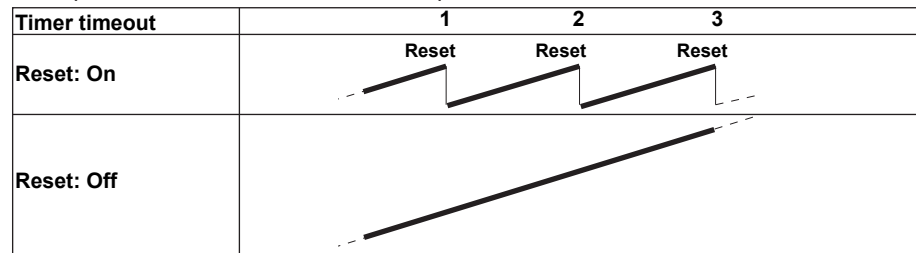

When reset is On, the sum value is calculated over each interval. When set to Off, the sum value from computation start is calculated.

Power Failure Operation, Handling of Error Data, and Handling of Overflow Data

See "Special Data Handling" in this section.

Report Function

This function is used to create hourly, daily, weekly, and monthly reports.

- **Report Data Types**

You can select from four types among maximum value, minimum value, average value, sum value, and instantaneous value.

- **Report Type**

Type	Description
Hourly report	Creates report data every hour on the hour for the previous one hour.
Daily report	Creates report data every day at a specified time for the previous one day.
Weekly report	Creates report data every week at a specified time at a specified day of the week for the previous one week.
Monthly report	Creates report data every month at a specified time at a specified day for the previous one month.

- **Combinations of Reports That Can Be Created**

You can select from hourly reports only, daily reports only, hourly and daily reports, daily and weekly reports, and daily and monthly reports.

- **Source Channels**

You can select from measurement channels and computation channels. The report data are not created for channels that are set to **Skip** or **Off**.

Model	Number of channels
DX1002, DX1004, DX1002N, DX1004N	12
DX1006, DX1012, DX1006N, DX1012N	24

- **Unit of Sum Computation**

In the sum computation, data are summed over the scan interval. However, for flow values that have units /s, /min, /h, or /day a simple summation results in the actual value not matching the computed result, because the scan interval and the unit of the input values are different. In such cases, set the sum scale to match the unit of the input value. In effect, the sum value with the same unit as that of the input value is calculated.

For example, if the scan interval is 2 s, and the input value is 100 m³/min, a simple summation would add 100 every 2 s resulting in 3000 after one minute. However, if the sum scale is set to /min, then 2 s/60 s is multiplied every scan interval before the value is added giving a result that has an m³/min unit.

The following converting equations are used to compute the sum. The unit of the scan interval is seconds.

Off: $\Sigma(\text{measured data every scan interval})$

/s: $\Sigma(\text{measured data every scan interval}) \times \text{scan interval}$

/min: $\Sigma(\text{measured data every scan interval}) \times \text{scan interval}/60$

/h: $\Sigma(\text{measured data every scan interval}) \times \text{scan interval}/3600$

/day: $\Sigma(\text{measured data every scan interval}) \times \text{scan interval}/86400$

- **Displaying the Report Data**

You can display the report data using keys.

For the operating procedure, see section 4.5.

- **Saving the Report Data**

See section 1.4, "Data Storage Function."

- **Numeric Display and Recording**

The numeric range of the report data is from -9999999 to 99999999 excluding the decimal point (except -3.4E+38 to 3.4E+38 for sum values).

For the data handling of special cases, see "Special Data Handling" in this section.

For details on the report file format, see appendix 3.

Special Data Handling

This section explains the handling of special data in TLOG computation, CLOG computation, and reports.

- **Power Failure Operation (TLOG and Reports)**

If a power failure occurs when the report function is enabled or in the middle of the TLOG computation, the report operation and TLOG computation resume when the DX recovers from the power failure. The operation varies depending on whether the DX recovers from the power failure before or after the time to create a report or TLOG data.

Time of Recovery	Operation
After the time to create the data	The report or TLOG data is created immediately after the DX recovers. The measured data up to the time of the power failure is used. At the time the next report or TLOG data is created, the data after the recovery is used.
Before the time to create the data	After the DX recovers, report or TLOG data is created at the normal time to create the data. The measured data excluding the power failure period is used.

- **Error Data Handling (TLOG, CLOG, and Reports)**

If an error occurs in the channel data, the error data is discarded, and the computation continues. If all the data are in error, an error results.

The following types of data are considered error data.

- Channels set to skip or Off.
- The measured result on a measurement channels is error (A/D converter failure, etc.).
- The input of the measurement channel is in a burnout condition.
- The computed result on a computation channel is error.

- **Handling of Overflow Data***

* Refers to over range on a measurement channel and computation overflow on a computation channel.

For TLOG, CLOG, and Reports

When the channel data is overflow data, the DX handles the data as follows:

Computation Type	Description
Average value or sum value	Set the handling to ERROR, SKIP, or LIMIT. ERROR: Considers the data to be a computation error. SKIP: Discards the overflow data and continues the computation. LIMIT: Replaces the data with the limit value and continues the computation. The limit value is the span upper or lower limit or the scale upper or lower limit of the channel.
Maximum, minimum, Maximum – minimum	Set the handling to OVER or SKIP. OVER: Computes by using the overflow data. SKIP: Discards the overflow data and continues the computation.

For Multiplication and Relation Computation EQ and NE

Computation Type	Computation	Computed Result
Multiplication	0*(+Over)	0
	0*(-Over)	0
	(+Over)*0	0
	(-Over)*0	0
.EQ.	(+Over).EQ.(+Over)	0
	(-Over).EQ.(-Over)	0
.NE.	(+Over).NE.(+Over)	1
	(-Over).NE.(-Over)	1

Report Template (Release numbers 4 and later)

You can create report templates and use them to automatically create custom report files.

Use Microsoft Office Excel (hereinafter referred to as “Excel”) to create report template files. Load a report template file that you have created into the DX internal memory. The DX will automatically create report files using the report template file.

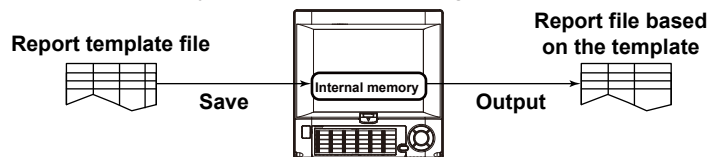

For the setting procedure, see section 9.5.

To create a report template, see section 9.6.

To load or save a report template, see section 6.10.

• Report Template

Item	Description
Format, extension	XML spreadsheet format. The file name extension is .xml (lowercase).
File name	You can specify a file name.
Type	You need to create different report templates for each report file type. The different report file types are hourly, daily, weekly, monthly, hourly + daily, daily + weekly, and daily + monthly.

• Template-Based Report File

Item	Description
Format, extension	XML spreadsheet format. The files can be opened in Excel. The file name extension is .xml (lowercase).
File name	Except for the extension, the file names of these files are the same as those of report files with .DAR extensions. For information about file names, see section 1.4, or see section 1.2 in the <i>Advanced Security Function (/AS1) User's Manual</i> .
Type	The reports of each report file type are created using the appropriate template file. The number of report files that can be created depends on the report creation range settings (see section 9.5). For example, when the report settings are not configured for the creation of daily reports, you cannot use a template to create daily reports. However, regardless of the report settings, you can output all the different types of report computations (average, maximum value, minimum value, sum value, and instantaneous value.)

• Creating Template-Based Report Files

Template-based report files are created (the creation of template-based report files will hereinafter be referred to as “template conversion”) in the following cases.

Auto Save

When a report file is created (when file division occurs), template conversion is performed, and the report file is saved to the CF card. Template conversion is also performed when recording stops (memory stop).

Manual Save (Collectively storing unsaved data)

When you save a report file manually, template conversion is performed on the report files in the internal memory that have not yet been converted. Converted files are saved to the external storage medium.

Collective Storing of Data through Key Operations

When you execute ALL SAVE or REPORT SAVE, template conversion is performed on all the report files in the internal memory. Converted files are saved to the external storage medium.

1.9 FAIL/Status Output Function (/F1 Option)

Output Relay Operation Assignment (Release numbers 4 and later)

For this function, there are relays labeled "FAIL" and "Status" on the rear panel.

You can assign the operations explained below to these two relays. On a relay that has been set to "Status relay," you must also set the DX status that will be relayed.

FAIL Output

When a failure occurs in the CPU of the DX, a relay contact signal (1 signal) is output. The relay is energized when the CPU is normal and de-energizes when a CPU failure occurs. Therefore, relay output is carried out also when the power is turned OFF (including a power failure). You cannot change this behavior.

Relay Operation

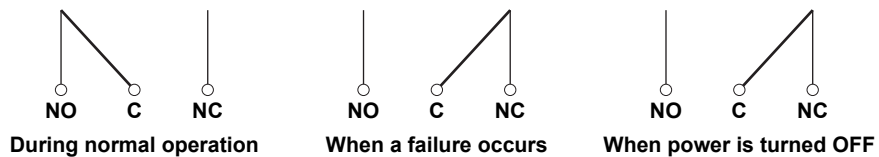

If a failure occurs, contact your nearest YOKOGAWA dealer for repairs.

Memory Sample Relay (Only on DXs with the /AS1 advanced security option)

The relay is energized at memory start and de-energized at memory stop. You cannot change this behavior

When the multi batch function (/BT2 option) is being used, memory start is when memory start occurs for any of the batches, and memory stop is when memory stop occurs for all the batches.

Relay Operation

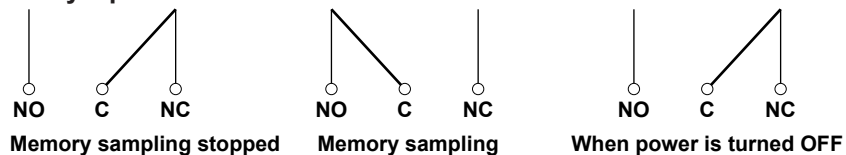

Invalid User Relay (Only on DXs with the /AS1 advanced security option)

The relay is energized when the user is invalid and de-energized when you execute the Locked ACK command. You cannot change this behavior

Relay Operation

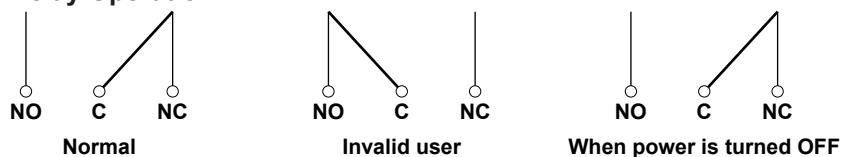

User Login Status Relay (Only on DXs with the /AS1 advanced security option)

The relay is energized when a user is logged in (through key operations or through communication commands) to the DX. You cannot change this behavior

Relay Operation

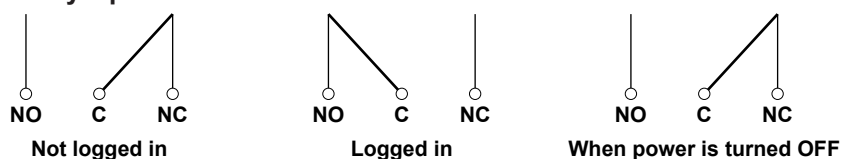

Status Output

Outputs the status below with a relay contact signal (1 relay). You can select whether each status is output to the relay. The relay is energized when the status occurs. You cannot change this behavior.

For the setting procedure, see section 2.9.

Status	Description	Corrective Action
Status of the internal memory or CF card	Error in the internal memory.	Contact your nearest YOKOGAWA dealer for repairs.
	When the auto save function to the CF card is On.	
	<ul style="list-style-type: none"> The free space on the CF card dropped to 10% of the total size (only when the media FIFO (see section 1.4) is disabled). Error in the CF card. 	<ul style="list-style-type: none"> Replace the CF card. Replace the CF card with a normal one. Format the CF card on the DX (the data on the CF card will be erased).
	<p>However, the status of the internal memory is output when the CF card is not inserted.</p> <ul style="list-style-type: none"> 10 MB or less of available space* remaining in internal memory. The number of files in internal memory for which Auto Save to the CF card has not been completed has exceeded 390. 	Insert a CF card.
Measurement error	Error in the A/D converter.	Contact your nearest YOKOGAWA dealer for repairs.
	Burnout is detected.	Replace the thermocouple that has burned out.
Communication error	A Modbus master or Modbus client communication error occurred.	Check the error in the Modbus master or Modbus client screen and carry out the corrective action.
	A PROFIBUS-DP communication error occurred.	Contact your nearest YOKOGAWA dealer for repairs.
Memory stop	When the memory sampling is stopped.	Start the data acquisition.
Alarm occurrence (Release number 3 or later)	An alarm has occurred.	Check the alarm.

- * The internal memory's "available space" refers to the following quantities.
- Unused regions
 - Regions of data for which Auto Save or Manual Save (see page 1-31) has been completed.

Relay Operation

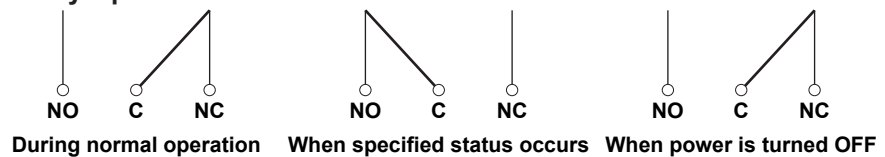

1.10 Other Functions

Time Related Functions

- **Time Correction**

The DX internal clock can be changed in the following manner.

Method	Description
Key operation	Sets the DX internal clock to the specified time.
Event action function	Synchronizes the DX internal clock to the nearest hour.
SNTP client function	Sets the DX internal clock to the time retrieved from an SNTP server.

Time Correction Operation

The time correction operation varies depending on whether the memory sampling is in progress or not.

Status	Operation
Memory sampling stopped	The DX internal clock is changed immediately.
Memory sampling	The DX internal clock is gradually corrected. While the time is being gradually adjusted, the date/time in the status display section is displayed in yellow.

Operation of Gradually Correcting the Internal Clock

If the time deviation between the time of the DX internal clock and the correct time (the specified time) is within a specified value, the DX clock is adjusted gradually at 40 ms for each second. Otherwise, the clock is corrected immediately. The maximum value of time deviation (t_m in the figure below) can be selected in the range of 10 s to 5 min.

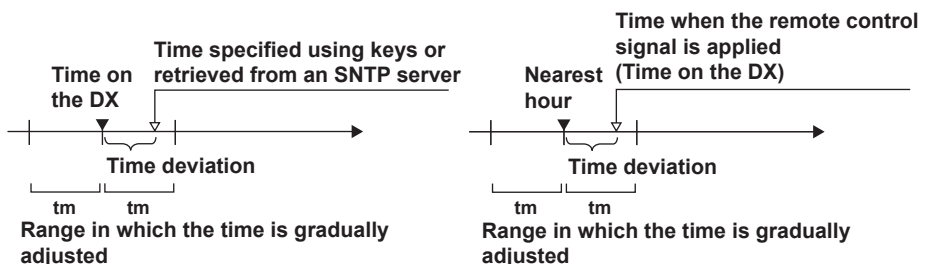

Example: When changing the time to 12 hours 55 minutes 35 seconds when the internal clock is 12 hours 55 minutes 32 seconds
The time deviation of 3 seconds is adjusted 40 ms per second. The internal clock will be synchronized to the specified time 75 seconds later.

- **Date Format**

You can select the display format of the data from “2005/09/28,” “09/28/2005,” “28/09/2005,” and “28.09.2005.”

For the setting procedure, see section 2.4.

- **Time Zone**

Set the time difference between the location where the DX is used and GMT.

For the setting procedure, see section 2.2.

- **DST (Daylight Saving Time)**

If you are using the DX in an area with daylight saving time, enter the daylight saving time starting and ending dates, and the DX will automatically change the time accordingly.

For the setting procedure, see section 2.1.

System Display

Displays the total number of inputs on the DX, the size of the internal memory, the communication functions, the external storage drive, the options, the remote controller ID, the operation of the devices connected to the USB ports (/USB1 option), the MAC address, and the firmware version number.
For the operating procedure, see section 2.5.

Language

The displayed language can be set to English, Japanese, German, French, or, Chinese.
For the setting procedure, see section 2.6.

24 VDC Power Supply for Transmitter (/TPS2 or /TPS4 Option)

Provides 24-VDC power supply to up to two (/TPS2) or four (/TPS4) two-wire system transmitters. The measured values of the transmitter correspond to a current signal of 4 to 20 mA on the same cable. Therefore, the signal can be connected to the DX input terminal and displayed.

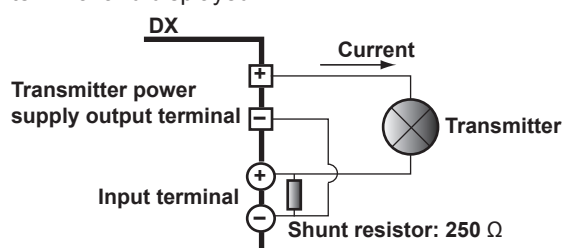

Easy Text Entry Option (/KB1 and /KB2 Options)

You can control the DX using the keys on the remote control terminal.

- Set the remote controller ID on the DX and the ID number on the remote control terminal to the same value.
- You can set a value between 0 and 31 for the remote controller ID and ID number.
- By changing the ID number on the remote control terminal, you can control DXs with different remote controller IDs from a single remote control terminal.

For the operating procedure, see section 2.10.

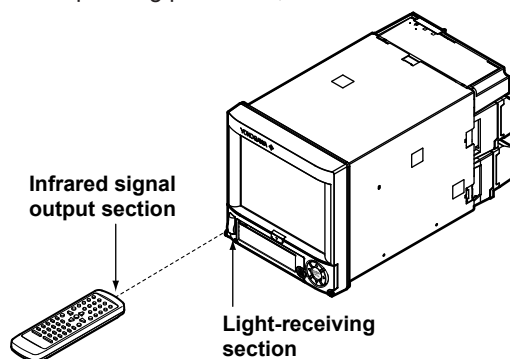

USB Interface (/USB1 option)

You can connect keyboards, barcode readers, or USB flash memory to two USB ports, one on the front and one on the back of the DX.

- You can operate the DX using a keyboard or barcode reader.
- You can save measured data and setup data to the USB flash memory and also load from it.

For the operating procedure, see sections 2.11 and 2.12.

Temperature Unit

You can set the unit when measuring temperature with the thermocouple or RTD to °C or °F.

For the setting procedure, see section 3.3.

Custom Display (Release numbers 3 and later)

You can create a custom operation screen.

See the *Custom Display User's Manual, IM04L41B01-04E*.

Multi Batch Function (/BT2 option; release numbers 3 and later)

You can use this function to simultaneously record the measured data from multiple batches.

See the *Multi Batch (/BT2) User's Manual, IM04L41B01-03E*.

Advanced Security Function (/AS1 option; release numbers 4 and later)

The advanced security option strengthens measurement security with login, audit trail, digital signature, and other functions.

See the *Advanced Security Function (/AS1) User's Manual, IM 04L41B01-05EN*.

2.1 Setting the Date/Time

Set the date/time. If you are using the DX in a region that uses DST, specify the date/time for switching between DST and standard time.

Setup Screen

- Date/Time**
 Press **MENU** (to switch to setting mode), and select the **Menu** tab > **Date/Time** > **Time Settings**.



- DST**
 Press **MENU** (to switch to setting mode), and select the **Menu** tab > **Date/Time** > **Daylight Saving Time**.

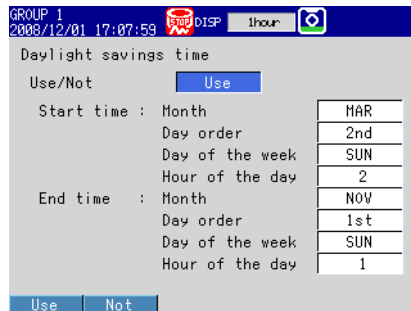

Setup Items

- Time set**
 Enter the date and time, select **ENT**, and press **DISP/ENTER**.
- Daylight savings time > Use/Not**
 To set a daylight saving time period, select **Use**.
- Daylight savings time > Start time**
 Specify the date and time when daylight saving time starts.

Item	Description
Month	Specify the month.
Day order (week order)	Specify the week within the month. Specify [Last] for the last week in the month.
Day of the week	Specify the day of the week.
Hour of the day	Specify the hour using a value from 0 to 23.

- Daylight savings time > End time**
 Specify the date and time when daylight saving time ends. The settings here are the same as those for Start time.

2.2 Setting the Time Difference from GMT

Set the time zone of the region in which the DX will be used. Make sure to set this value if you are using the Internet network functions or the DST function.

Setup Screen

Press **MENU** (to switch to setting mode), hold down **FUNC** for 3 s (to switch to basic setting mode), and select the **Menu** tab > **Time Settings**.

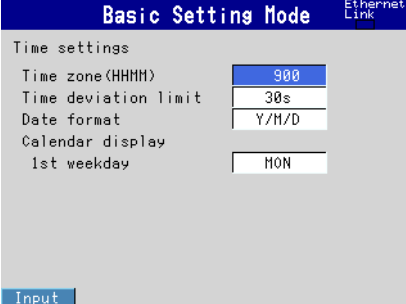

The screenshot shows the 'Basic Setting Mode' screen with the following settings:

Basic Setting Mode		Ethernet Link
Time settings		
Time zone(HHMM)	900	
Time deviation limit	30s	
Date format	Y/M/D	
Calendar display		
1st weekday	MON	

Input

Setup Items

- **Time settings > Time zone(HHMM)**

Set the time zone of the region in which the DX will be used in terms of the time difference from GMT. Specify a value in the range of -1300 to 1300 (where the first two digits denote the hour and the last two digits denote the minute). A negative value indicates that the local time is behind the GMT.

Example: The standard time in Japan is ahead of the GMT by 9 hours. In this case, enter "900."

2.3 Setting the Time Correction Operation during Memory Sampling

This function gradually corrects the time when the time is changed while Memory Sampling is in progress.

For a description of the time correction operation, see section 1.10.

Setup Screen

Press **MENU** (to switch to setting mode), hold down **FUNC** for 3 s (to switch to basic setting mode), and select the **Menu** tab > **Time Settings**.

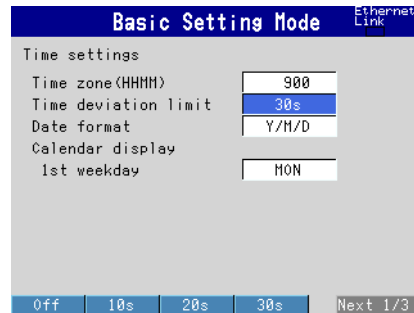

Setup Items

- Time settings > Time deviation limit

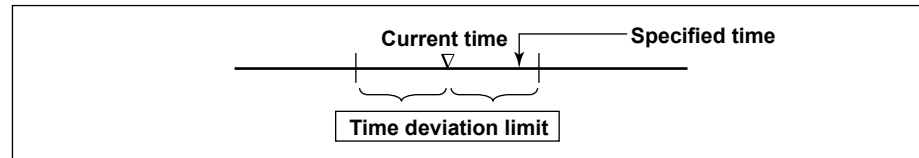

When the time deviation between the time on the DX and the specified time is within \pm (the value specified here), the time on the DX is gradually corrected. Otherwise, the clock is corrected immediately. Note that time is not corrected on DXs with the Advanced security function (/AS1 option) when the specified time is over the time deviation limit. (Firmware version numbers 4.11 and later)

Settings	Description
10 s to 5 min	The time deviation limit.
Off	Disables the function that gradually corrects the time.

Example: If **Time deviation limit** is set to **10s** and the time on the DX is 10 hours 21 minutes 15 seconds, the time on the DX is gradually corrected if the specified time is between 10 hours 21 minutes 5 seconds and 10 hours 21 minutes 25 seconds.

Note

On DXs with the Advanced security function (/AS1 option), you cannot change the time during memory sampling if the time deviation limit is set to OFF. (Firmware version number 4.11 and later)

2.4 Setting the Date Format

Select the display format of the date.

Setup Screen

Press **MENU** (to switch to setting mode), hold down **FUNC** for 3 s (to switch to basic setting mode), and select the **Menu** tab > **Time Settings**.

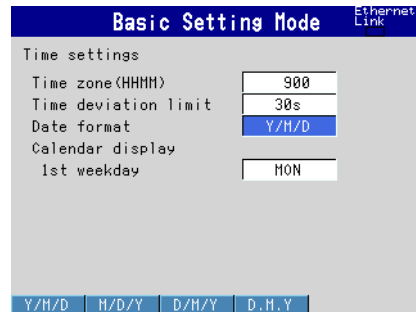

Setup Items

- Time settings > Date format

Settings	Display Example	
	Dates other than the grid time of the trend display	Time at the grid position in the trend display (example: 8 O'clock on Nov. 30)*
Y/M/D	2005/11/30	11/30 08
M/D/Y	11/30/2005	11/30 08
D/M/Y	30/11/2005	30/11 08
D.M.Y	30.11.2005	30.11 08

* Only if the trend interval is set greater than or equal to 1 h/div. A function available on DXs with release number 2 or later.

Applied Range

The format is applied to the date displayed on the screen. It does not change the date format on the setup screen of the date/time, the date in the output data via communications, the date saved along with the data, and the date used in the data file names.

2.5 Viewing the DX Information

Show the DX information on the system information screen and the network information screen.

Procedure

- **Displaying System Information Screen**
 1. In the operation mode, press **FUNC**.
The FUNC key menu appears.
 2. Press the **System info soft key**.
The system information screen is displayed.
- **Displaying Network Information Screen**
 1. In the operation mode, press **FUNC**.
The FUNC key menu appears.
 2. Press the **Network info soft key**.
The network information screen is displayed.

Explanation

- **System Information Screen**

The screenshot shows the following fields and their corresponding descriptions:

- ANALOG: 12** → **ANALOG: Number of measurement channels** (C) denotes the clamped input terminals (/H2 option).
- MATH: 2** → **MATH: Number of computation channels** (/M1 and /PM1 options)
- MEMORY: 80MB** → **MEMORY: Internal memory size**
- OPTION:**
 - ETHERNET
 - ALARM 2
 - FAIL/STATUS
 - REMOTE
 - CF
 - USB
- REMOTE CONTROLLER ID : 2** → **Remote controller ID** (/KB1 and /KB2 option)
- USB HID Device : Key Board** → **USB HID** (/USB1 option)
- PRODUCT:**
 - MAC address 00:00:64:88:26:28
 - Version 3.01a06
- Version: 3.01a06** → **Firmware version**

The following items are displayed:

- Number of measurement channels.
- Number of computation channels.
- Internal memory size
- Options
- Remote controller ID (/KB1 and /KB2 options)
- Connected USB HID devices (/USB1 option)
- MAC address
- Firmware version

2.5 Viewing the DX Information

- **Network Information Screen**

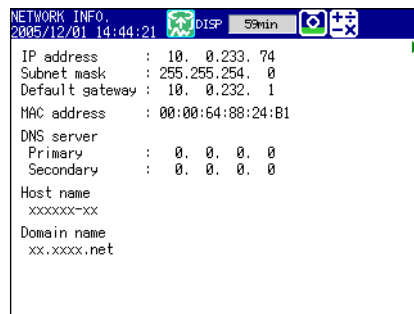

There are two pages of network information. Use the left and right arrow keys to switch the screen. The following items are displayed:

- IP address
- Subnet mask IP address
- Default gateway IP address
- MAC address
- DNS server IP address
- Host name
- Domain name
- The server function setting conditions listed below.
FTP, Web, Modbus, SNTP, and EtherNet/IP
- PROFIBUS-DP information (/CP1 option)
Node address and serial number (maintenance information)

2.6 Changing the Displayed Language

Set the displayed language.

Setup Screen

Press **MENU** (to switch to setting mode), hold down **FUNC** for 3 s (to switch to basic setting mode), and select the **Environment** tab > **Operating Environment**.

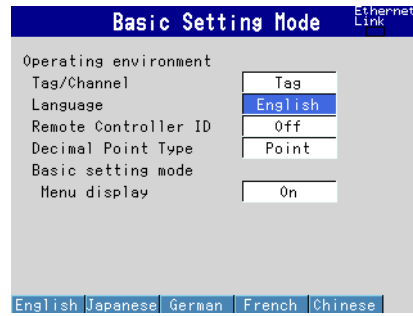

Setup Items

- **Operating environment > Language**
Set the displayed language to **English**, **Japanese**, **German**, **French**, or **Chinese**.

2.7 Setting the LCD Brightness and Backlight Saver

Change the LCD brightness. In addition, set the backlight saver function to prolong the service life of the LCD backlight.

Setup Screen

Press **MENU** (to switch to setting mode), and select the **Menu** tab > **Display** > **LCD**.

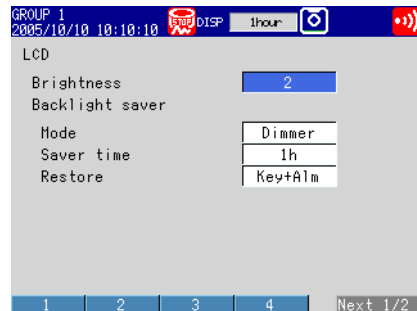

Setup Items

- **LCD > Brightness**

Select a value from 1 to 8 (2 by default). Larger the value, brighter the display becomes.

- **LCD > Backlight saver > Mode**

Settings	Description
Off	Disables the backlight saver.
Dimmer	Dims the display if there is no operation for a given time.
Timeoff	Turns the backlight OFF if there is no operation for a given time.

- **LCD > Backlight saver > Saver time**

Select a value from 1 min to 1 h. If the specified time elapses without any key operation or alarm occurrence, the LCD backlight switches to the specified mode.

- **LCD > Backlight saver > Restore**

Settings	Description
Key	The backlight returns to the original brightness when a key is pressed.
Key+Alm	The backlight returns to the original brightness when a key is pressed or when an alarm occurs.

Note

- If the backlight is dimmed or turned OFF by the backlight saver function, pressing any key on the DX causes the backlight to return to the original brightness. In this operation, the key does not perform its intended function.
- The degradation of the brightness and the discoloration of the screen (become yellowish) tend to progress faster as the brightness is set higher. Extended use at an unnecessary high setting should be avoided. It is also recommended that you use the backlight saver function.

2.8 Initializing Settings and Clearing the Internal Memory

Initialize the settings to default values. In addition, clear the data in the internal memory. For the default settings, see the *DX1000/DX1000N Operation Guide (IM04L41B01-02E)*.

Setup Screen

Press **MENU** (to switch to setting mode), hold down **FUNC** for 3 s (to switch to basic setting mode), and select the **File/Initialize** tab > **Initialize**.

On DXs without the /AS1 advanced security option

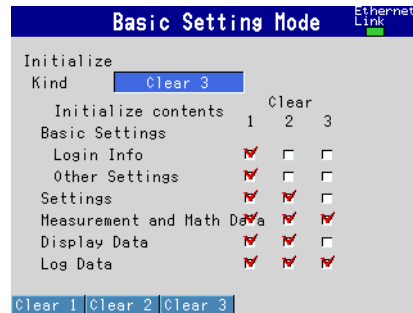

On DXs with the /AS1 advanced security option

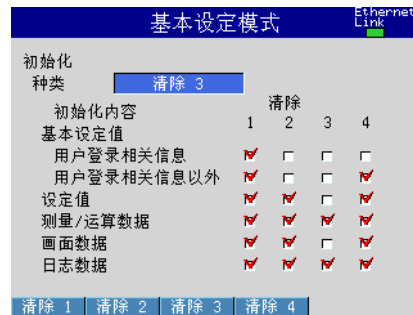

2.8 Initializing Settings and Clearing the Internal Memory

Setup Items

- **Initialize**

On DXs without the /AS1 advanced security option

Settings	Description
Clear 1	Clears and initializes the data in the internal memory in the manner indicated on the screen.
Clear 2	
Clear 3	

Internal Memory Data That Is Initialized or Cleared

Item	Description
Basic Settings	
Login Info	The "Authority of user" settings in basic setting mode are initialized.
Other Settings	All settings in basic setting mode other than the "Authority of user" settings are initialized.
Settings	The setting mode settings are initialized.
Measurement and Math Data	Display, event, manual sampling, and report (/M1 and /PM1 options) data is cleared.
Display Data	The custom display screen setup data is cleared.
Log Data	All the log data is cleared.

On DXs with the /AS1 advanced security option

Setting	Description
Clear 1	Clears and initializes the data in the internal memory in the manner indicated on the screen.
Clear 2	
Clear 3	
Clear 4	

Internal Memory Data That Is Initialized or Cleared

See the explanation for DXs without the /AS1 advanced security option.

Procedure

1. Press the **Clear 1**, **Clear 2**, **Clear 3**, or **Clear 4** soft key.
2. Press **DISP/ENTER**.
A confirmation window opens.
3. Select **Yes** and press **DISP/ENTER**.
The specified operation is executed, and the DX returns to the operation mode.
If you do not want to initialize, select **No** and press **DISP/ENTER**.

2.9 Outputting the DX Status via the Relay Contact (/F1 Option)

A signal is output to a dedicated relay when an error occurs in the DX CPU. In addition, a signal is output to a different relay when the a specified status occurs.
For a description of the FAIL/status output function, see section 1.7.

Setup Screen

- **Assigning Relay Operations**

Press **MENU** (to switch to setting mode), hold down **FUNC** for 3 s (to switch to basic setting mode), and select the **Menu** tab > **Status relay**> **Relay Action**.

On DXs without the /AS1 advanced security option

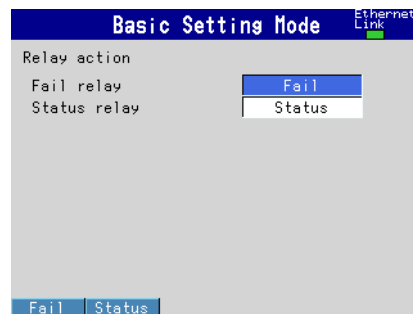

On DXs with the /AS1 advanced security option

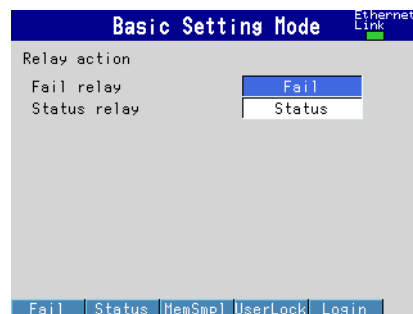

2.9 Outputting the DX Status via the Relay Contact (/F1 and /F2 Options)

- **Status Relay Details**

Press **MENU** (to switch to setting mode), hold down **FUNC** for 3 s (to switch to basic setting mode), and select the **Menu** tab > **Status Relay** > **Status Relay Details**.

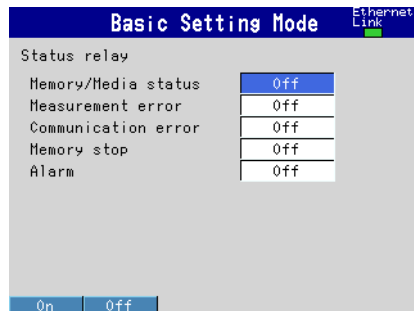

Setup Items

- **Relay Action > Fail Relay, Status Relay (Release numbers 4 and later)
On DXs without the /AS1 advanced security option**

Setting	Description
Fail	Outputs a fail relay.
Status relay	Outputs a status relay. Even if you set both relays to "Status relay," you cannot make them output different statuses.

On DXs with the /AS1 advanced security option

Setting	Description
Fail	Outputs a fail relay.
Status relay	Outputs a status relay. Even if you set both relays to "Status relay," you cannot make them output different statuses.
Mem. sample*	Relay output continues from memory start until memory stop.
Invalid user	Relay output continues from when a user is determined to be invalid until a Locked ACK command is executed.
Login	Relay output occurs whenever a user is logged in.

* When the multi batch function (/BT2 option) is being used, relay output starts when memory start occurs for any of the batches, and relay output stops when memory stop occurs for all the batches.

- **Status Relay Details > Memory/Media status**

On: The status of the internal memory and the CF card is relayed.

- **Status Relay Details > Measurement error**

On: A relay signal is output when a measurement error occurs.

- **Status Relay Details > Communication error**

On: A relay signal is output when a communication error occurs.

- **Status Relay Details > Memory stop**

On: A relay signal is output when memory sampling stops.

* When the multi batch function (/BT2 option) is being used, relay output starts when recording stops for all the batches.

- **Status Relay Details > Alarm (Release numbers 3 and later)**

On: Outputs a relay signal when one or more alarms occur. Alarms whose indications are hidden (see section 3.6 for details) do not cause relay signal output. Relay output ceases after all alarms are released (if no other relay output conditions are met).

Procedure

- **FAIL Output**

There are no operations that are required. A signal is output to the relay contact when a CPU error is detected. A signal is also output to the relay contact when the DX is turned OFF.

- **Status Relay**

A signal is output to the relay contact when a specified status occurs.

2.10 Controlling the DX with the Remote Control Terminal (/KB1 and /KB2 Options)

Handling Precautions

- If the infrared signal output section of the remote control terminal or the light-receiving section on the DX becomes dirty or receives scratches, it can hinder the transmission/reception of the infrared signal. Clean the infrared signal output section of the remote control terminal or the light-receiving section on the DX.
- When cleaning, wipe using a dry soft cloth. Do not use chemicals such as benzene or thinner, since these may cause discoloring and deformation.
- Do not apply shock to the remote control terminal.
- Do not operate the remote control terminal with wet hands.
- The transmission/reception sensitivity of the infrared signal may deteriorate if used in the following types of locations.
 - Location where the receiver of the DX is exposed to direct sunlight or fluorescent lamp.
 - Near magnetic field sources such as a transceiver.
- If you carry the remote control unit in your pocket, for example, keys may be pressed unintentionally and cause the DX to be controlled. Handle the remote control terminal properly so that keys are not pressed inadvertently.
- When you are near the DX, press the keys on the remote control terminal only when controlling the DX. If you are going to press the keys on the remote control terminal but do not wish to control the DX, take measures so that the signal does not reach the DX such as by covering the infrared signal output section of the remote control terminal.
- The distance at which the DX can be controlled using the remote control terminal varies depending on the operating environment such as the battery voltage and the presence or absence of external light.
- There is a possibility that DXs with the same remote controller ID be controlled simultaneously. It is recommended that different remote controller IDs be set on each DX.

Preparing the DX

Set the remote controller ID.

- **Setup Screen**

Press **MENU** (to switch to setting mode), hold down **FUNC** for 3 s (to switch to basic setting mode), and select the **Environment** tab > **Operating Environment**.

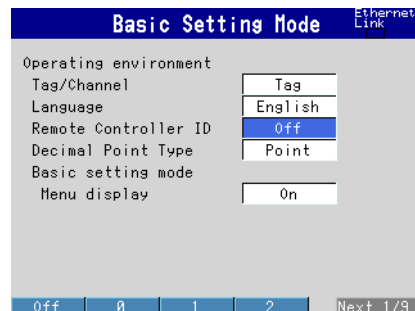

- **Operating environment > Remote Controller ID**

Select the remote controller ID from **0** to **31**. When not using the remote control terminal, select **Off**.

- **Checking the Remote Controller ID**

You can check the DX remote controller ID on the system information screen. See section 2.5.

Preparing the Remote Control Terminal

• Names of Parts

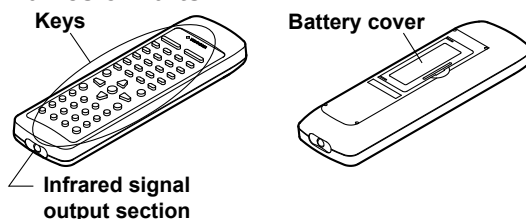

• Loading Batteries

1. While pressing the projection on the battery cover, open the cover.

2. Load the batteries.

3. Close the battery cover.

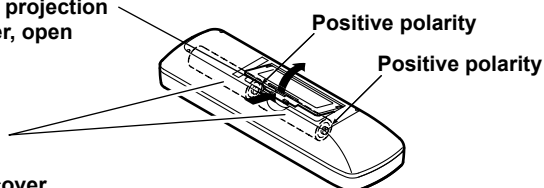

• Setting the ID Number

Set the ID number of the remote control terminal to match the remote controller ID of the DX that you are to operate.

The ID number of the remote control terminal is not displayed anywhere. If you are not sure which ID number the remote control terminal is set to, set the appropriate ID number according to the following procedure.

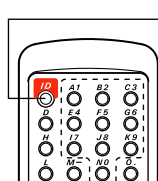

1. Press ID.

2. Enter the ID number (0 to 31) by pressing the keys from 1 (A1) to 0 (N0).

Example For ID number "16"
Operation: Press 1 (A1) and 6 (G6).

3. Press ID.

Note

- If you enter an ID number other than 0 through 31, the ID number retains the original setting.
- Pressing the ID key once causes the remote control terminal to enter the ID number setup mode. If none of the keys on the remote control terminal is pressed for 8 s, the remote control terminal automatically exits from the ID number setup mode. In this case, the ID number of the remote control terminal retains the original setting.
- If you remove the batteries, the ID number is reset to 0. After loading the batteries, set the appropriate ID number again.

• Affixing the ID Number Label

If you are using the remote control terminal with a fixed ID number (such as when there is a one-to-one correspondence between the DX to be controlled and the remote control terminal), you can enter the ID number on the label and affix the label on the remote control terminal.

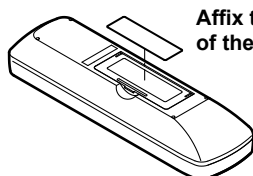

Affix the ID number label on the battery cover of the remote control terminal.

Controlling the DX

Control the DX by pointing the infrared output section of the remote control terminal to the light-receiving section on the DX. Control the DX while checking the results on the DX screen.

Note

- The remote control terminal cannot be used to control the Favorite key.
- When a specific key operation is possible on the DX, the corresponding key on the remote control terminal is activated. For example, the operation for entering a character string is activated when a window for entering a character string is displayed on the DX screen.
- You cannot control the DX using the remote control terminal, if the remote control terminal is in the ID number setup mode.
- On models with the /M1 math option or /PM1 pulse input option, use the keys on the DX to enter the computing equation of the computation channel. Computing elements are not assigned to the keys on the remote control terminal.

• **Correspondence with the DX Keys**

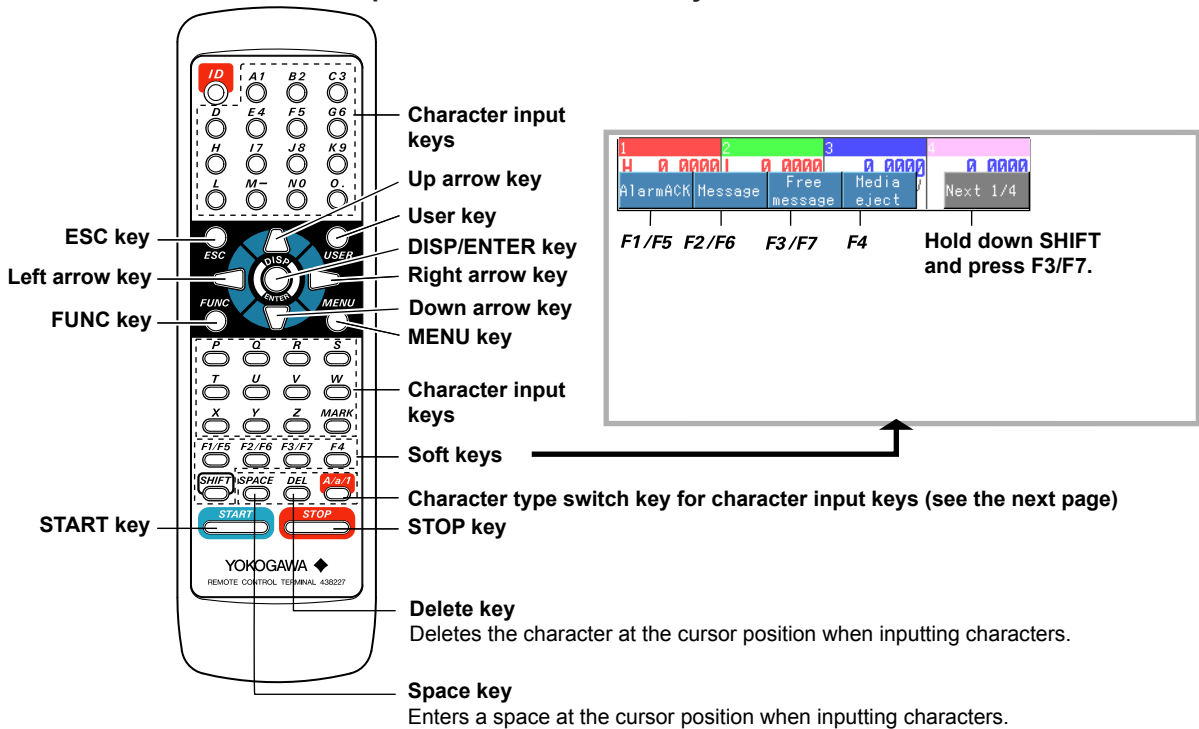

2.10 Controlling the DX with the Remote Control Terminal (/KB1 and /KB2 Options)

- **Entering Strings**

When a character input window is displayed on the DX screen, pressing the A/a/1 key switches the character type assigned to the character input keys as shown in the following figure.

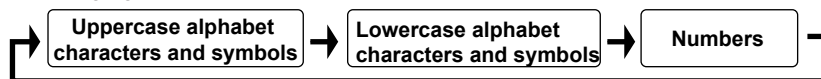

- **Uppercase Alphabet Characters and Symbols/Lowercase Alphabet Characters and Symbols**

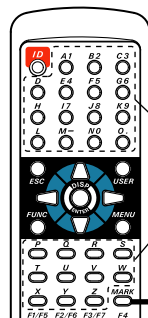

Alphabet (A to Z or a to z)

Press the MARK key to cycle through the following symbols:

Number of times the key is pressed	1	2	3	4	5	6	7	8	9	10	11	12	13
Symbol	%	#	°	@	_	()	:	[]	+	*	/

- **Numbers**

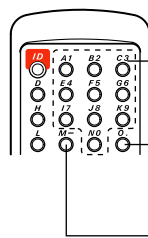

Number (1 to 9 and 0)

Decimal point

However, when setting a constant to be used in the computation on the DX with the /M1 or /PM1 option, the display switches in the order “.”, “+”, and “E” each time the key is pressed. The display switches in a cyclic pattern.

Minus sign

Troubleshooting

The DX does not react when you try to control it using the remote control terminal.

- **Are the correct batteries loaded in the remote control terminal?**
Check the voltage and polarity of the batteries.
- **Are the batteries flat?**
Replace the batteries with new ones.
- **Does the ID number of the remote control terminal match the remote controller ID of the DX that you are trying to control?**
Check the remote controller ID on the DX, and set the ID number of the remote control terminal to the same value.
- **Is the remote control terminal in ID number setup mode (condition in which the ID key is pressed once)?**
Wait 8 seconds without pressing any keys to exit from ID number setup mode.
- **Is the remote control terminal too far away from the DX?**
Get closer to the DX. Control from as close to the front of the DX as possible.
- **Is a strong light hitting the light-receiving section of the DX?**
Take measures to prevent strong light from hitting the light-receiving section of the DX.
- **Is there a magnetic field source such as a transceiver nearby?**
Move the magnetic field source away from the DX.
- **Is the infrared output section of the remote control terminal or the light-receiving section on the DX dirty?**
Clean them.
- **Is the DX in a condition that allows the relevant key operation?**
Check the condition of the DX, and start from an operation that is possible.

2.11 Controlling the DX with a Keyboard or Barcode Reader (/USB1 option)

This section explains how to connect and use a USB keyboard or barcode reader.

Barcode readers can be used if the DX release number is 3 or later.

Connecting and Disconnecting a Keyboard or Barcode Reader

• Connection

1. Connect the keyboard or barcode reader to a DX USB port.

A display appears asking whether you have connected a keyboard or a barcode reader.

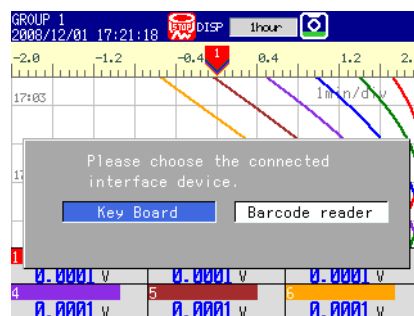
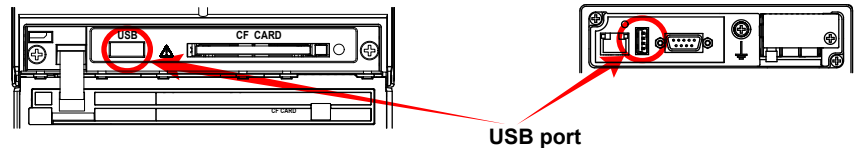

2. Select the type of device that you have connected, and then **DISP/ENTER**.

You can now use the device that you connected.

* If you change the display without selecting a device, the device type is automatically set to keyboard.

* This setting is unrelated to the connection of USB flash memory.

• Removal

Remove the keyboard or barcode reader cable from the DX USB port.

Note

- You can connect and remove keyboards and barcode readers at any time, regardless of the display and whether the DX is on or off.
- You can only connect one human interface device (HID) to the DX. You cannot use a keyboard and a barcode reader at the same time.
- Use a keyboard that matches the DX language setting.
- The statuses of the Caps Lock and Num Lock keys are retained even if the USB keyboard is removed (release number 2 and later). However, if a bar code reader is connected, the key statuses will be initialized to off.
- The device that is currently connected is indicated in the system information display (see section 2.5 for details).

Operating from the Keyboard

Use the keyboard while watching the DX screen. An operation that can be carried out on the DX can be carried out from the keyboard.

Example: Switch to setting mode

When the DX is in the operation mode, press Ctrl+M.

The DX switches to setting mode, and the setting menu appears.

- **Mapping of the Keys on the DX to the Keys on the Keyboard**

Keys on the Keyboard 104 Keyboard (US)for the PC	Keys on the DX
Enter	DISP/ENTER
←	Left arrow key
↑	Up arrow key
↓	Down arrow key
→	Right arrow key
Num Enter	DISP/ENTER
Esc	ESC
F1 to 5	Soft key 1 to soft key 5
F9	FUNC
F12	Hold down FUNC for 3 seconds
Left-Windows	MENU
Right-Windows	MENU
Application	Favorite key
Ctrl+S	START
Ctrl+P	STOP
Ctrl+U	USER
Ctrl+M	MENU
Ctrl+F	Favorite key
Tab, Shift+Tab	Arrow keys*

* Press **Tab** to move the cursor to the next item, or **Shift+Tab** to move to the previous item. However, this does not work in the following screens:
 Operation screens, Menu screens for Setting mode and Basic setting mode, screens for entering values and characters, "Menu customize" and "Save/Load" screens in Setting mode, and "Load setting, Initialize" screen in Basic setting mode

- **Entering Alphabets, Numbers, and Symbols**

When alphabets, numbers, and symbols can be entered on the DX, you can enter them from the keyboard. The operation is the same as with normal keys. However, symbols that cannot be used on the DX are invalid.

Symbols That Can Be Entered Using the Keyboard

The symbols below can be entered. However, symbols that cannot be used on the DX are invalid. For example, the characters *, /, :, and ? cannot be used in the data save destination directory name.

#	%	()	*	+	-	.	/	:	?	@	[]	^	_
---	---	-----	---	---	---	---	---	---	---	---	-----	---	---

* Press "A" on the keyboard to enter the temperature degree symbol.

- **Invalid Keys**

Keys enclosed in frames are invalid.

The 104 Keyboard for a PC (US)

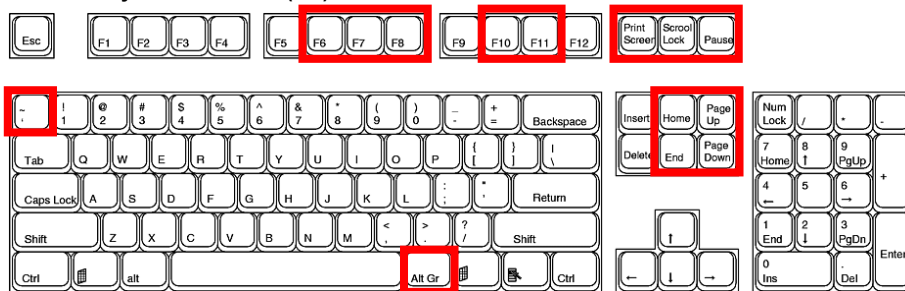

Barcode Reader Operations (Release number 3 or later)

When you scan communication commands with a barcode reader, the DX will respond as follows.

- The DX will accumulate key codes until it reaches a terminator. Then it will execute the accumulated character string. The terminator is the enter key code.
- The DX can accumulate up to 200 characters, not including the terminator. The DX will process a character string when it reaches 200 characters in length.
- The DX can read ASCII characters (128 characters: numbers, symbols, and uppercase and lowercase letters of the alphabet).

Note

- Barcode reader operations are treated as key operations.
 - Barcode reader operations except the operation using UD command are limited by the settings of the key lock and login functions.
-

- **Barcode Reader Settings**

Configure the barcode reader to the settings in the table below.

USB host parameter	Setting
USB device type	HID keyboard simulation
USB keyboard type	English (U.S.) standard USB keyboard

- **How to Use**

Follow the standard operating procedure for the barcode reader that you are using. Operate the barcode reader while checking the status of the DX. An operation can be carried out using the barcode reader when it can be carried out on the DX.

- **Commands**

Scan the communication commands encoded in bar codes to operate the DX with a barcode reader. The communication commands that you can use are listed in the table below. For information about communication command syntax, see the *Communication Interface User's Manual, IM 04L41B01-17E*.

Command	Description
KE	Performs key operations
PS	Starts or stops memory sampling
EV	Starts manual sampling Causes triggers to occur Takes snapshots Saves display data Saves event data
MS	Writes messages
TL	Starts or stops computation Resets computation Clears the computation data dropout display
IR	Resets the relative timer
AK	Releases alarm output (alarm ACK)
CV	Switches the trend interval
EM	Starts or stops e-mails
CU	Manually recovers the Modbus master or client
BJ	Writes free messages
BV	Inserts characters
BT	Sets batch names
BU	Sets batch comments
CL	Executes manual SNTP
LO	Reads the setting mode setup data
LI	Saves setup data
MA	Resets the single match time timer
YC	Clears measured and computed data and initializes setup data
EJ	Changes login passwords
YO	Loads setup files (for basic setting mode)
UD	Switches the screen
MH	Writes batch text fields (release numbers 4 and later)
BP	Enters login information (/AS1 option; release numbers 4 and later)
BQ	Invalid user ACK operation (/AS1 option; release numbers 4 and later)
EC	Initialization (/AS1 option; release numbers 4 and later)

- **Command Example**

The command to write message number 8 in group 1 is: MS8,GRPUP,1. There must be a terminator (an enter key code) at the end.

- **Note**

- You can read multiple commands (as many as 10) by putting sub delimiters (semicolons) between them.
Example: PS0;MS8,GRPUP,1
- When you enter commands using bar codes, you can enter them separated or all at once. You can separate commands however you want to. For example, you can separate the command to write message number 8 in group 1, *MS8,GRPUP,1*, into the following components: MS > 8 > , > GRPUP > , > 1 > ENTER key code.
- If you use a barcode reader that automatically attaches a footer and a header to every transmission, the result will be the same if MS is set to the header, the enter key code is set to the footer, and you scan *8,GRPUP,1*.
- When the DX receives an unsupported key code, it clears all of the key codes that it has accumulated so far.

2.12 Using the USB Flash Memory (/USB1 Option)

Connecting/Removing a USB Flash Memory

- **Connecting a USB Flash Memory**

If you are using the multi batch function (/BT2 option), see the *DX1000/DX1000N/DX2000 Multi Batch (/BT2) User's Manual, IM04L41B01-03E*.

1. Connect a USB flash memory to the USB port on the DX.
2. In operation mode, possible operations are shown. Select the desired operation using the **arrow keys** and press **DISP/ENTER**.

When set to auto save

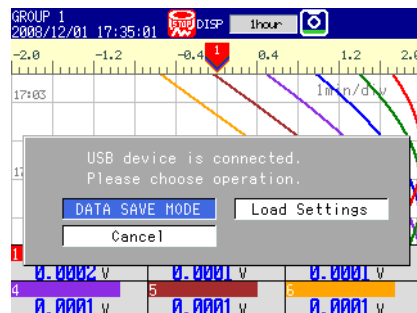

When set to manual save

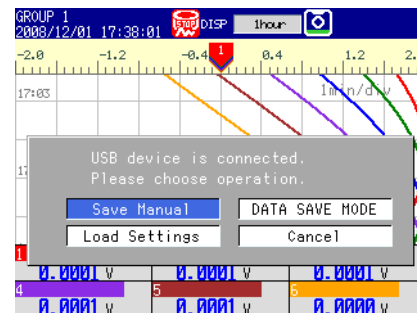

Setting	Description
Save Manual	Saves unsaved data in the internal memory to a USB flash memory device.
DATA SAVE MODE	Switches to the DATA SAVE MODE display. For the procedure to save the internal memory data, see section 4.8. This item only appears when the DX is configured to display DATA SAVE MODE in the display menu (release number 2 and later). You can change the item that is displayed here with the menu customize function.
Load Settings	Moves to the setup load display of setting mode. For the procedure to load the setup data, see section 6.9. Load Settings will not be displayed: <ul style="list-style-type: none"> • When Media/USB loading is locked (see chapter 8 for details). • When the DX is accessing storage media (formatting, saving, or FTP communication).
Cancel	Closes the operation selection window.

- **Removing the USB Flash Memory**

1. In the operation mode, press **FUNC**.
The FUNC key menu appears.
2. Press the **Media eject** soft key and then the **USB** soft key.
A message "Media can be removed safely." appears.
3. Remove the USB flash memory.

Note

- One USB flash memory can be connected.
- Be sure to carry out the procedure above when removing the USB flash memory. If you remove the USB memory without performing the above procedure, the data stored on it could be damaged.

Saving and Loading Data

The following data save/load and file operations can be carried out.

Save/Load setup data files (see section 6.9).

Save display data and event data files (see sections 4.8 and 6.4).

Load display data and event data files (see section 6.8).

List files and delete files (see section 6.7).

Format (see section 6.7).

2.13 Setting the Decimal Point Type (Release number 3 or later)

You can set the decimal point type for the display and files saved in text format.

Setup Screen

Press **MENU** (to switch to setting mode), hold down **FUNC** for 3 s (to switch to basic setting mode), and select the **Environment** tab > **Operating Environment**.

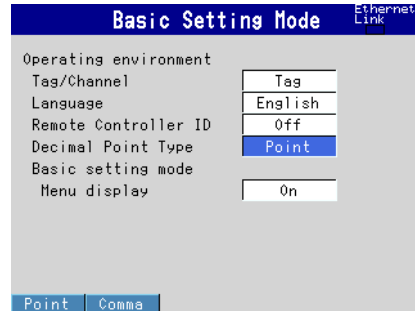

Setup Items

- **Decimal Point Types**

Setting	Display Example
Point	1234.56
Comma	1234,56

Explanation

- **Decimal Point Types**

The decimal point type setting affects the following kinds of files and displays. The decimal point of any file or setting not listed below (the setup screen for example) is displayed using a period.

Type	Item
File output	Manual sampled data file Report file
Display	Trend display Digital display Bar graph display Overview display Historical trend Report data display Custom display
Webpage	All channel display
E-mails	The instantaneous value data in alarm e-mails and scheduled e-mails. The report data in report e-mails

2.14 Showing or Hiding the Menu Item for Switching from Setting Mode to Basic Setting Mode (Release number 3 or later)

Set whether or not to display a menu item in the setting mode menu for switching to basic setting mode.

Setup Screen

Press **MENU** (to switch to setting mode), hold down **FUNC** for 3 s (to switch to basic setting mode), and select the **Environment** tab > **Operating Environment**.

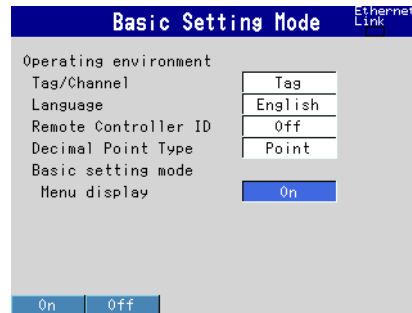

Setup Items

- **Basic Setting Mode > Menu display**

Setting	Description
On	Displays "Basic setting mode" in the setting mode menu.
Off	Basic setting mode is not displayed in the setting mode menu.

Operations

When "Basic setting mode" appears in the setting mode menu, you can perform the following operation:

1. Press **MENU** and select the **Menu** tab > **Basic setting mode**. Then press **DISP/ENTER**.
A confirmation window opens.
2. Select **Yes**, and press **DISP/ENTER**.
The basic setting mode menu appears.

Note

Regardless of this setting, you can switch from setting mode to basic setting mode by holding down the **FUNC** key for 3 seconds.

3.1 Setting the Scan Interval and the Integration Time of the A/D Converter

Select the scan interval and the integration time of the A/D converter.
 For a description of the scan interval and the integration time of the A/D converter, see section 1.1.

Setup Screen

Press **MENU** (to switch to setting mode), hold down **FUNC** for 3 s (to switch to basic setting mode), and select the **Menu** tab > **A/D, Memory**.

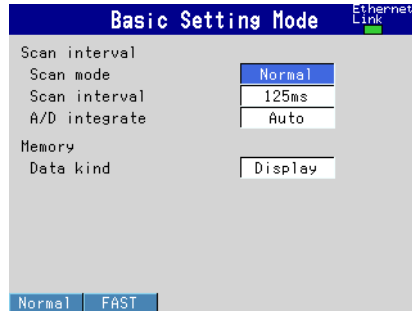

Setup Items

- Scan interval > Scan mode**
 Normal: Measures at the normal mode scan interval.
 * The scan mode is fixed at Normal when the multi batch function (/BT2 option; release numbers 3 and later) is being used.
 FAST: Measures at a scan interval of 25 ms (DX1002, DX1004, DX1002N, and DX1004N) or 125 ms (DX1006, DX1012, DX1006N, and DX1012N).
- Scan interval > Scan interval**
 The selectable settings appear.
- Scan interval > A/D integrate**
 When the scan mode is set to **Normal**, select the A/D integration time as necessary. Only the selectable settings are displayed.

Settings	Description
Auto	The DX automatically detects the power supply frequency and sets the integration time to 16.7 ms and 20 ms for 60 Hz and 50 Hz, respectively. Fixed to 20 ms on /P1 models that use the 24 VDC power supply.
50Hz	Sets the integration time to 20 ms.
60Hz	Sets the integration time to 16.7 ms.
100ms	Sets the integration time to 100 ms (when the scan interval is 2 s or 5 s).
600Hz	The A/D integration time for fast sampling mode. You cannot change this value.

3.2 Setting the Burnout Detection and the Reference Junction Compensation of the Thermocouple Input

Set the function that detects burnouts in the sensor for thermocouple input and 1-5V input and the reference junction compensation method of the thermocouple.

Setup Screen

Press **MENU** (to switch to setting mode), hold down **FUNC** for 3 s (to switch to basic setting mode), and select the **Menu** tab > **Burnout, RJC**.

The screenshot shows the 'Basic Setting Mode' screen with the following settings:

- First-CH: 001
- Last-CH: 001
- Burnout set: Off
- RJC Mode: External
- RJC Volt: 0 μV

At the bottom, there are navigation buttons for 'Input', '+1', and '-1'. An 'Ethernet Link' indicator is visible in the top right corner.

Setup Items

- **First-CH, Last-CH**

Select the target channels.

- **Burnout set**

Detects thermocouple and 1-5V input sensor burnouts.

Settings	Description
Off	Does not detect burnouts in the sensor.
Up	When the sensor burns out, the measured result is set to +over range. The measured value displays "Burnout." For 1-5V input, the DX assumes that the sensor has burned out when the measured value exceeds the scale upper limit by 10% of the scale width. (Example: When the measured value is greater than 110 when the scale is from 0 to 100)
Down	When the sensor burns out, the measured result is set to -over range. The measured value displays "Burnout." For 1-5V input, the DX assumes that the sensor has burned out when the measured value falls below the scale upper limit by 5% of the scale width. (Example: When the measured value is less than -5 when the scale is from 0 to 100)

- **RJC > Mode**

Sets the reference junction compensation method of the thermocouple input. Select **Internal** or **External**.

Settings	Description
Internal	Uses the reference junction compensation function of the DX.
External	Uses an external reference junction compensation function. When set to External , Volt is displayed.

- **RJC > Volt**

The compensation voltage to be added to the input. Set the value in the range of -20000 μV to 20000 μV .

3.3 Setting the Input Range

Set the input range for each channel.

Setup Screen

- **Temperature Unit**

Press **MENU** (to switch to setting mode), hold down **FUNC** for 3 s (to switch to basic setting mode), and select the **Environment** tab > **Operating Environment**.

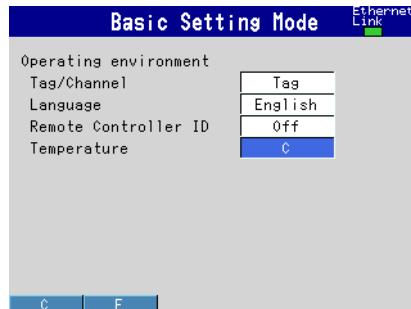

- **Input Range for Each Channel**

Press **MENU** (to switch to setting mode), and select the **Menu** tab > **Meas channel** > **Range, Alarm**.

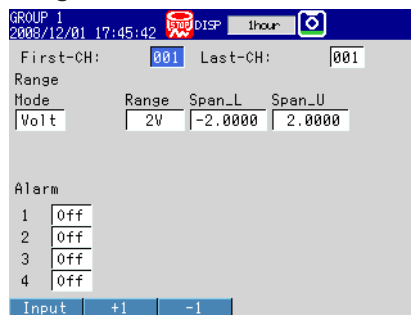

Setup Items

- **Temperature**

Select the temperature unit. The setting is applied to all temperature measurement channels.

Settings	Description
C	Use Celsius
F	Use Fahrenheit

3.3 Setting the Input Range

- **First-CH, Last-CH**
Select the target channels.

- **Range > Mode**

Settings	Description
Skip	Not measured.
Volt, TC, RTD, DI, 1-5V	Input type. Represents DC voltage, thermocouple, RTD, ON/OFF input, and 1-5V inputs, respectively.
Delta, Scale, Sqrt	Difference computation, linear scaling, and square root computation.

Set the items with check marks in the table below according to the mode value.

Setup Item	Mode								
	Volt	TC	RTD	DI	Delta	Scale	Sqrt	1-5V	Skip
Type					✓	✓			
Range	✓	✓	✓	✓	✓	✓	✓	✓	
Span Lower	✓	✓	✓	✓	✓	✓	✓	✓	
Span Upper	✓	✓	✓	✓	✓	✓	✓	✓	
Scale Lower						✓	✓	✓	
Scale Upper						✓	✓	✓	
Unit						✓	✓	✓	
Ref. CH					✓				
Low-cut							✓	✓	
Low-cut value							✓		

- **Range > Type**
Input type when **Mode** is **Delta** or **Scale**. See the description on Mode above.

- **Range > Range**

Input type details.

Setting	Input Type	Notes	Setting	Input Type	Notes
20mV	-20.000 mV to 20.000 mVDC	Standard	R	Type R	Standard
60mV	-60.00 mV to 60.00 mVDC				
200mV	-200.00 mV to 200.00 mVDC				
2V	-2.000 V to 2.000 VDC				
6V	-6.000 V to 6.000 VDC				
20V	-20.000 V to 20.000 VDC				
20V	-50.00 V to 60.00 VDC				
Pt	Pt100				
JPt	JPt100				
Level	ON/OFF(Voltage)				
Contact	ON/OFF(Contact)				
1-5V	0.800V to 5.200V				
S	Type S				
B	Type B				
K	Type K				
E	Type E				
J	Type J				
T	Type T				
N	Type N				
W	Type W				
L	Type L				
U	Type U				
WRe	type WRe				

Setting	Input Type	Notes	Setting	Input Type	Notes
Kp	Kp vs Au7Fe	/N3 option	Cu1	Cu10 (GE)	/N1 option
PLATI	PLATINEL				
PR	PR40-20				
NiMo	NiNiMo				
W/WRe	W/WRe26				
N2	Type N (AWG14)				
XK	XK GOST*1				
Pt50	Pt50				
Ni1	Ni100 (SAMA)				
Ni2	Ni100 (DIN)				
Ni3	Ni120				
J263	J263*B				
Cu53	Cu53				
Cu100	Cu100: a = 0.00425 at 0°C				
Pt25	Pt25				
Pt100G	Pt100 GOST*1				
Cu100G	Cu100 GOST*1				
Cu50G	Cu50 GOST*1				
Cu10G	Cu10GOST*1				
Pt46G	Pt46 GOST*1				
Pt200W	Pt200(WEED)*2				
Cu2	Cu10 (L&N)				
Cu3	Cu10 (WEED)				
Cu4	Cu10 (BAILEY)				
Cu5	Cu10: a = 0.00393 at 20°C				
Cu6	Cu10: a = 0.00393 at 20°C				
Cu25	Cu25: a = 0.00425 at 0°C				

*1 A function available on DXs with release number 3 or later.

*2 This function is available for release numbers 4 and later.

- **Range > Span_L, Span_U**

Input range. The selectable range is displayed on the screen.

Note

- You cannot set the same value to **Span Lower** and **Span Upper**.
- When the **Mode** is **1-5V** or **Sqrt**, **Span Lower** must be less than **Span Upper**.

- **Range > Scale_L, Scale_U**

Input range after converting the unit.

The selectable range is from -30000 to 30000. The decimal place is determined by the **Scale Lower** setting. It can be set to the following positions: "X.XXXX," "XX.XXX," "XXX.XX," "XXXX.X," or "XXXXX."

Note

- The DX converts the measured value to a value obtained by removing the decimal point from the value span specified by **Scale Lower** and **Scale Upper**. For example, if the scale setting is "-5 to 5," the value is converted to a value within the span of "10"; if the scale setting is "-5.0 to 5.0," the value is converted to a value within a span of "100." In this case, the resolution of the value converted to a span of "10" is lower than the value converted to a span of "100." To prevent the display from becoming rough, it is recommended that the scale be set so that this value is greater than 100.
- You cannot set the same value to **Scale Lower** and **Scale Upper**.
- When the **Mode** is **1-5V** or **Sqrt**, **Scale Lower** must be less than **Scale Upper**.

- **Range > Unit**

Set the unit (up to 6 characters, $[A][a][\#][1]$).

- **Range > Ref. CH**

The reference channel for difference computation.

- **Range > Low-cut**

Select **On** to use the low-cut function.

* The low-cut value for 1 to 5 V input is fixed to 0% value of the input span.

- **Range > Value**

On a square root computation channel, set the low-cut value in the range of 0.0% to 5.0% of the input span.

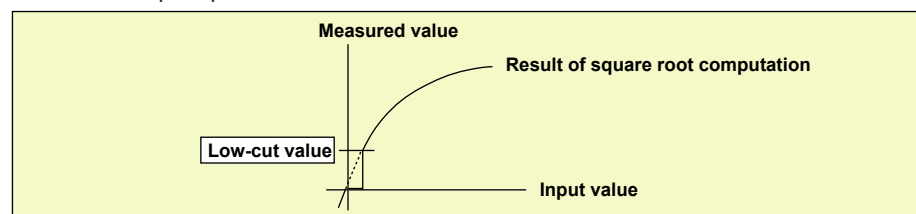

3.4 Setting the Moving Average of the Input

Set the moving average function of the measurement channel. This function suppresses the effects of noise.

For a description of the function, see section 1.1.

Setup Screen

Press **MENU** (to switch to setting mode), and select the **Menu** tab > **Meas channel** > **Moving average**.

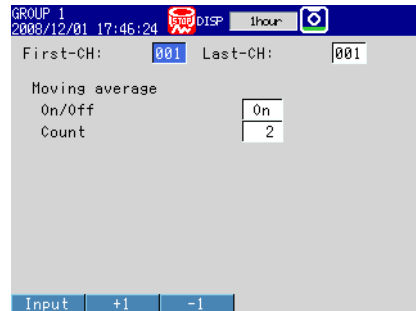

Setup Items

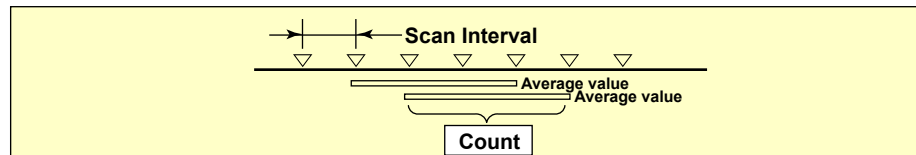

- **First-CH, Last-CH**
Select the target channels.
- **Moving average > On/Off**
To use moving average, select **On**.
- **Moving average > Count**
Set the number of data points of the moving average in the range of 2 to 400.

3.5 Setting the Auxiliary Alarm Function

Setup Screen

Press **MENU** (to switch to setting mode), hold down **FUNC** for 3 s (to switch to basic setting mode), and select the **Menu** tab > **Alarm** > **Basic settings; Switch, Relay;** or **Hysteresis**.

- Basic settings

The screenshot shows the 'Basic Setting Mode' screen with the following settings:

Setting	Value
Reflash	Off
Rate of change	
Decrease	1
Increase	1
Indicator	Nonhold

At the bottom, there are buttons for 'On' and 'Off'.

- Switch, Relay

The screenshot shows the 'Basic Setting Mode' screen with the following settings:

Setting	Value
Internal Switch	
AND	None
Relay	
AND	None
Action	Energize
Hold	Nonhold
Relay Action on ACK	Normal

At the bottom, there are buttons for 'None', 'S01', 'S01-S02', 'S01-S03', and 'Next 1/8'.

- Hysteresis

The screenshot shows the 'Basic Setting Mode' screen with the following settings:

Setting	Value
Meas CH	
High/Low	0.5
Delta High/Low	0.0
Math CH	
High/Low	0.0

At the bottom, there is an 'Input' button.

Setup Items

- **Basic settings > Reflash**

To set the reflash operation on the alarm output relay, select **On**. The reflash function is set on the first three output relays.

Setting	Description
Off	Reflash is not used.
On	Reflash is used. The relays are deactivated for approximately 500 ms.
On-1s	Reflash is used. The relays are deactivated for approximately 1 s.
On-2s	Reflash is used. The relays are deactivated for approximately 2 s.

- **Basic settings > Rate of change**

- **Decrease**

Set the interval for the rate-of-change calculation of the low limit on rate-of-change alarm in terms of the number of sampled data points (1 to 32). The actual interval is obtained by multiplying the value specified here by the scan interval.

- **Increase**

Set the interval for the rate-of-change calculation of the high limit on rate-of-change alarm in the same manner as the interval for the low limit on rate-of-change alarm.

3.5 Setting the Auxiliary Alarm Function

- **Basic setting > Indicator**

You can choose to make the alarm displays behave in the following ways. When you use the alarm annunciator function (release number 3 or later), the setting follows the annunciator sequence.

Settings	Description
Nonhold	Clears the alarm indication when the alarm condition is released (returns to normal condition).
Hold	Holds the alarm indication until an alarm acknowledge operation is performed.

- **Switch, Relay**

- **Internal Switch > AND**

Select the internal switches that are to operate using AND logic. Set the range of internal switches (from the first internal switch) to take the AND logic. All subsequent switches will be set to OR logic.

- **Relay > AND**

Select the relays that are to operate using AND logic. Set the range of relays (from the first alarm relay) to take the AND logic. All subsequent relays will be set to OR logic. Available settings are **None**, **I01** (I01 only), **I01-I02** (I01 and I02), **I01-I03** (I01 to I03), etc. Only alarm output relays that are installed are valid.

Note

When reflash is turned ON, the operation of the first three output relays is fixed to OR logic. Specifying **AND** produces no effect.

- **Relay > Action**

Select whether the alarm output relay is energized or de-energized when an alarm occurs. The setting applies to all alarm output relays.

- **Relay > Hold**

You can choose to make the alarm output relays behave in the following ways. This setting applies to all relays. When you use the alarm annunciator function (release number 3 or later), the setting follows the annunciator sequence.

Settings	Description
Nonhold	Turns the output relay OFF when the alarm condition is released (returns to normal condition).
Hold	Holds the output relay at ON until an alarm acknowledge operation is performed.

Note

When reflash is turned ON, the operation of the first three output relays is set to nonhold. Specifying **Hold** produces no effect.

- **Relay > Relay Action on Ack**

You can select the relay output status that is enabled after the AlarmACK operation from the following two settings. When you use the alarm annunciator function (release number 3 or later), the setting follows the annunciator sequence.

Settings	Description
Normal	The relay is deactivated when the alarm ACK operation is executed. If the condition for activating the alarm output relay is met in the next scan interval, the relay is activated. This operation is valid only when the alarm output relay is set to Hold .
Reset	The relay is deactivated when the alarm ACK operation is executed. If a new condition for activating the alarm output relay is met, the relay is activated.

An example of the relay action when alarm ACK is executed is shown below. This example is for the case when the output relay **AND** item is set to **None**.

Normal

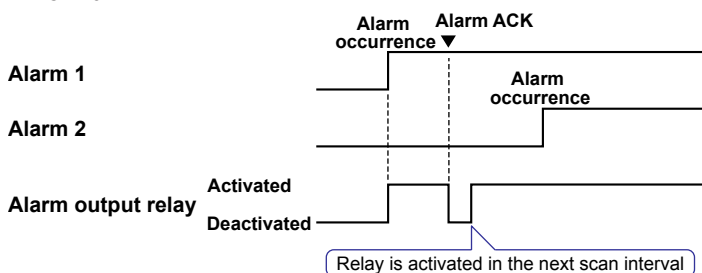

Reset

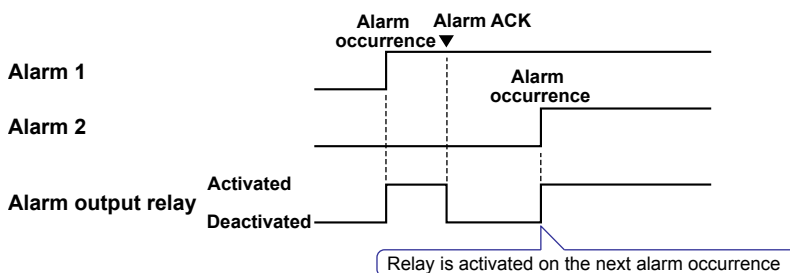

- **Hysteresis > Meas CH**

- **High/Low**

Sets the hysteresis width of the alarm occurrence/release of the high/low limit alarm specified on measurement channels.

Selectable range: 0.0% to 5.0% of the span or scaling width

- **Delta High/Low**

Sets the hysteresis width of the alarm occurrence/release of the difference high/low limit alarm specified on measurement channels.

Selectable range: 0.0% to 5.0% of the span

- **Hysteresis > Math CH (/M1 and /PM1 options)**

Sets the hysteresis width of the alarm occurrence/release of the high/low limit alarm specified on computation channels.

Selectable range: 0.0% to 5.0% of the measurement span

3.6 Hiding the Alarm Indication

Select whether to enable the alarm hide function.

Setup Screen

Press **MENU** (to switch to setting mode), hold down **FUNC** for 3 s (to switch to basic setting mode), and select the **Environment** tab > **Alarm** > **Action**.

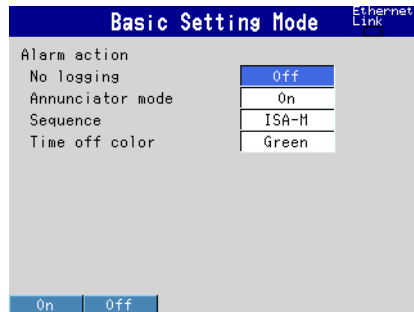

Setup Items

- **Alarm action > No logging**

To enable the function that turns off the alarm indicator and logging, select **On**. The **Detect** setup item is displayed in the alarm setting screen (see section 3.7).

This function disables the alarm indicator and the logging of alarm events to the alarm summary. Alarms are also not displayed by the alarm annunciator (release number 3 or later).

- **Settings for Each Channel and Each Alarm**

See section 3.7.

3.7 Setting Alarms on Channels

Set the alarms after setting the range. All alarm settings of a channel are cancelled in the following cases.

- When the input type (**Volt**, **TC**, etc.) is changed.
- When the input range is changed.
- When the upper or lower limit of the span or scale is changed on channels that are set to linear scale, square root computation, or 1-5 V (including changes in the decimal point position).

Setup Screen

• Alarms for Each Channel

Press **MENU** (to switch to setting mode), and select the **Menu** tab > **Meas channel** > **Range, Alarm**.

Mode	Range	Span_L	Span_U
Volt	2V	-2.0000	2.0000

No.	Type	Value	Relay	No.	
1	On	H	0.5000	On	101
2	Off	H	0.5000	On	101
3	Off	H	0.5000	On	101
4	Off	H	0.5000	On	101

• Alarm Delay Time

Press **MENU** (to switch to setting mode), and select the **Menu** tab > **Meas channel** > **Tag, Memory, Delay**.

On DXs without the /AS1 advanced security option

On DXs with the /AS1 advanced security option

3.7 Setting Alarms on Channels

- **Alarm Levels and Colors (Release number 3 or later)**

Press **MENU** (to switch to setting mode), hold down **FUNC** for 3 s (to switch to basic setting mode), and select the **Environment** tab > **Alarm** > **Alarm level/color**.

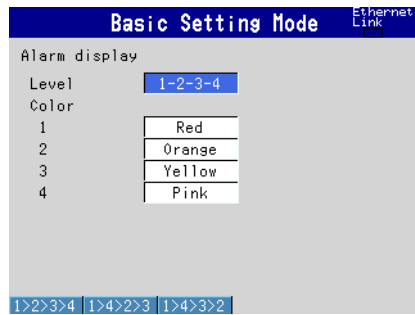

Setup Items

- **First-CH, Last-CH**
Select the target channels. The target channels are common with the other items that are displayed on the screen.
- **Alarm > 1, 2, 3, and 4**
For each alarm, 1 to 4, select **On** to enable it.
- **Alarm > Type**
Select the alarm type.

Settings Name	Description
H High limit alarm	–
L Low limit alarm	–
h Difference high limit alarm	Can be specified on channels set to difference computation.
l Difference low limit alarm	Can be specified on channels set to difference computation.
R High limit on rate-of-change alarm	–
r Low limit on rate-of-change alarm	–
T Delay high limit alarm	–
t Delay low limit alarm	–

Alarms on channels set to difference computation are inserted at the following positions.

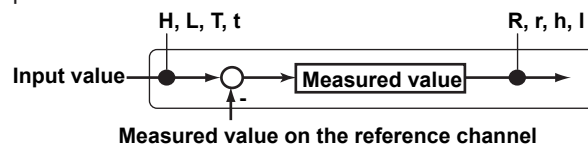

- **Alarm > Value**
Set the alarm value for the selected alarm type.

When the Mode of the Channel Is Set to Volt, TC, RTD, or DI

Type	Value	Example of a Range of Alarm Values
H, L	Value in the measurable range	–2.0000 to 2.0000 V for 2 V range
R, r	1 digit to the upper limit of the width of the measurable range However, less than or equal to 30000 excluding the decimal point.	0.0001 to 3.0000 V for 2 V range 0.1 to 1760.0°C for thermocouple type R
T, t	Same as H and L.	Same as H and L.

When the Mode of the Channel Is Set to Delta

Type	Value	Example of a Range of Alarm Values
H, L	Value in the measurable range	–2.0000 to 2.0000 V for 2 V range
h, l	Value in the measurable range	–1760.0 to 1760.0°C for thermocouple type R
R, r	1 digit to the width of the measurable range However, less than or equal to 30000 excluding the decimal point.	0.0001 to 3.0000 V for 2 V range 0.1 to 1760.0°C for thermocouple type R
T, t	Same as H and L.	Same as H and L.

When the Mode of the Channel Is Set to Scale, Sqrt, or 1-5V

Type	Value	Example of a Range of Alarm Values
H, L	–5% to 105% of the scale width. However, within –30000 to 30000 excluding the decimal point.	–5.0 to 105.0 when the scale is 0.0 to 100.0 –120.00 to 300.00 when the scale is –100.00 to 300.00
R, r	Within 1 to 30000 excluding the decimal point.	0.1 to 3000.0 when the scale is 0.0 to 100.0 0.01 to 300.00 when the scale is –100.00 to 300.00
T, t	Same as H and L.	Same as H and L.

3.7 Setting Alarms on Channels

- **Alarm > Relay**
Select whether to turn **On** or **Off** the relay output.
- **Alarm > No.**
Set the output relay number or internal switch number when performing relay output.
- **Alarm > Detect**
This item appears when the alarm hide function (see section 3.6) is turned **On**. Select whether to show or hide the alarm indication when an alarm occurs. If set to **Off**, a signal is output to the alarm output relay or internal switch when an alarm occurs, but it is not indicated on the screen. The alarm is also not recorded in the alarm summary, and alarms are not displayed by the alarm annunciator (release number 3 or later).
- **Alarm delay > Time (for delay high/low limit alarms)**
Set the alarm delay time using an integer in the range of 1 to 3600 s.
On DXs with the /AS1 advanced security option, you can set the delay time to a value within the range of 1 to 3600 seconds or 1 to 24 hours.

Note

- The alarm delay time takes on a value that is an integer multiple of the scan interval. For example, if the alarm delay time is set to 5 s when the scan interval is 2 s, the actual delay time is 6 s.
 - The delay alarm has the following special operations.
 - If the computation is stopped in a condition in which the computed value is exceeding the alarm setting when a delay alarm is set on a computation channel, the alarm is turned On after the specified period (delay period) elapses.
 - The alarm detection operation is reset if a power failure occurs. The operation restarts after the power recovers.
 - If the alarm setting of the delay high limit alarm is changed when an alarm is already activated and the input is greater than or equal to the new setting, the alarm continues. For all other cases, the alarm detection operation starts at the new setting. This is also true for the delay lower limit alarm.
-

- **Alarm delay > Unit (For delay high/low limit alarms)**
This setting is only available on DXs with the /AS1 advanced security option. Set the unit of the alarm delay time. You can select seconds or hours.
- **Alarm display > Level (Release number 3 or later)**
When multiple alarms occur, the display of alarms with higher levels is given higher priority. This setting applies to all channels.

Setting	Description
1>2>3>4	The order of alarm level preference, from highest to lowest preference, is 1, 2, 3, 4.
1>4>2>3	The order of alarm level preference, from highest to lowest preference, is 1, 4, 2, 3.
1>4>3>2	The order of alarm level preference, from highest to lowest preference, is 1, 4, 3, 2.

- **Alarm display > Color (Release number 3 or later)**
Determines the alarm color for each alarm level. This setting applies to all channels.

Item	Setting
1	Sets the alarm level 1 color to red, orange, yellow, or pink.
2	Sets the alarm level 2 color.
3	Sets the alarm level 3 color.
4	Sets the alarm level 4 color.

3.8 Releasing the Alarm Output (Alarm ACK Operation)

This operation is valid when the DX is set as follows:

DX with release number 3 or later

- When **Annunciator mode** is set to **On** in the basic setting mode.
- When **Annunciator mode** is set to **Off**, the operation is the same as described for DX with release number 2 below.

DX with release number 2

- When **Indicator** is set to **Hold** in the basic setting mode.
- When **Relay Hold** is set to **Hold** and **Relay action on ACK** is set to **Normal** in the basic setting mode.
- When **Relay action on ACK** is set to **Reset** in the basic setting mode.

DX before release number 2

- When **Indicator** is set to **Hold** in the basic setting mode.
- When **Relay Hold** is set to **Hold** in the basic setting mode.

For the procedure to set the relay action, see section 3.5.

On a DX with advanced security (/AS1 option; release numbers 4 and later), you can perform separate alarm ACK operations on each alarm.

For information about individual alarm ACK operations, see section 4.4.

Procedure

This operation is carried out after an alarm occurs.

1. In the operation mode, press **FUNC**.
The FUNC key menu appears.
2. Press the **AlarmACK** soft key.
The alarm output is released.

Explanation

• Alarm Acknowledge (ACK) Operation

When an alarm acknowledge operation is carried out, the indications and outputs (relays and switches) of all activated alarms are cleared.

In annunciator mode (release number 3 or later), the alarm indications and outputs follow the annunciator sequence.

3.9 Performing Calibration Correction (/CC1 Option)

The input value is corrected using segments, and the result is used as a measured value. For a description of the function, see section 1.1.

Setup Screen

Press **MENU** (to switch to setting mode), and select the **Menu** tab > **Meas channel** > **Calibration correction**.

	MES_val	True_val
1	0.0000	0.0000
2	0.5000	0.5100
3	1.0000	1.0200
4	1.5000	1.5500
5	2.0000	1.9900

Setup Items

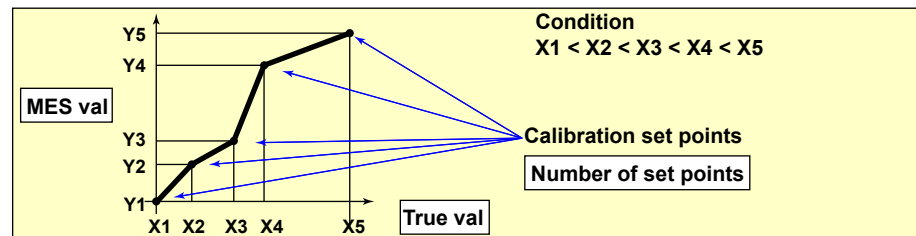

- **First-CH, Last-CH**
Select the target channels. You can set consecutive channels whose range is set to the same value as the first channel.
- **Number of set points**
Select the number of points that make up the segments (including the start and end points) in the range of 2 to 16.
To disable calibration correction, select **Off**.
- **Number of set points > MES val, True val**
Press the **Input** soft key and enter the value.
For the MES value, set a value that is greater than the previous value.
Press the **Measure** soft key to set the measured value at that point to MES val. If you press the **Measure** soft key when setting multiple channels simultaneously, the measured value of the first channel are set to the MES val of all channels.

Selectable Range of MES and True Values

- **Channels on which linear scaling is specified**
–30000 to 30000 (the decimal place is the same setting as the scale value)
- **Other channels**
Value in the measurable range of the selected range
Example: –2.0000 to 2.0000 for 2 V range

Note

- The calibration correction setting is set to **Off** if you change the **Mode** or **Range** setting.
- Calibration correction cannot be specified on channels set to **Skip**.

3.10 Counting Pulses (/PM1 Option)

The pulses applied to the pulse input terminal are counted on a computation channel. For a description of the function, see section 1.1.

Setup Screen

Press **MENU** (to switch to setting mode), and select the **Menu** tab > **Math channel** > **Expression, Alarm**

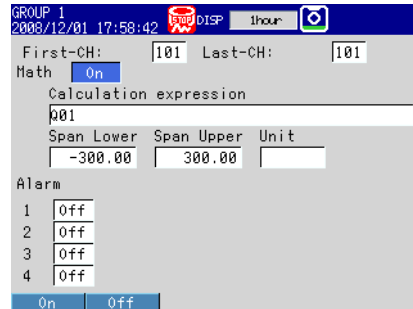

Setup Items

- **First-CH, Last-CH**
Select the target computation channels.
- **Math**
Select **On**.
- **Math > Calculation expression**
Enter the equation using symbols.
Q01 to Q08: Displays the number of pulses per second.
P01 to P08: Displays the number of pulses per scan interval.
* The numbers 01 to 08 correspond to the pulse input terminal numbers.
For the procedure to set the computation channels, see section 9.1.

The procedure is explained below using an example.

- **Example 1: Pulse Sum Value**

Display the sum value of the pulse signal applied to pulse input terminal number 6.

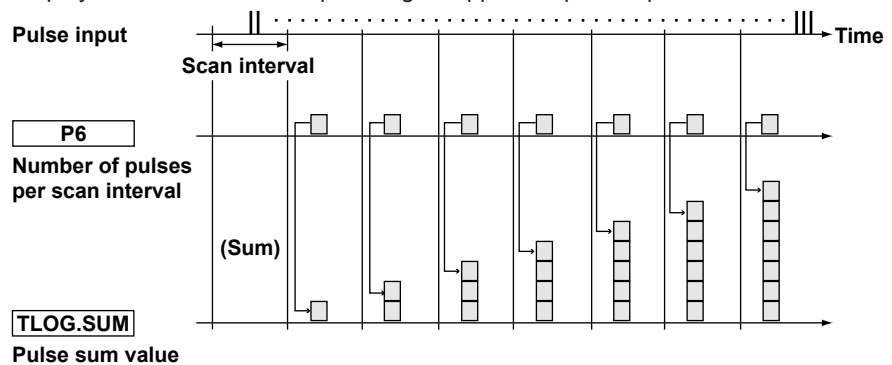

Expression

Assign the computation channel and set the expression. Set the span lower/upper limit and unit according to the application.

Channel	Equation	Description
101	TLOG.SUM(P6)	Sum of the number of pulses per scan interval

3.10 Counting Pulses (/PM1 Option)

- **Example 2: Number of Pulses per Minute**

Count the pulse signal applied to pulse input terminal number 6 on the DX1002 (scan interval set to 250 ms), and calculate and display the number of pulses per minute.

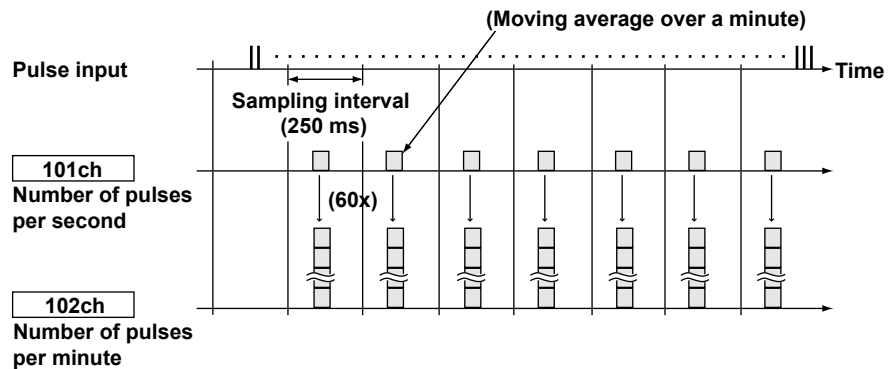

Expression

Assign the computation channel as shown below and set the expressions. Set the span lower/upper limit and unit according to the application.

Channel	Equation	Description
101	Q6	Number of pulses per second
102	101*K01	Number of pulses per minute

Constant	Value	Description
K01	60	Coefficient for converting the number of pulses per second to the number of pulses per minute

Channel	Rolling average	Description
101	Sampling interval: 1s Number of samples: 60	Moving average over a minute

Channels

The computation is performed in order from the channel with the smallest channel number in one scan interval.

Use a channel of a channel number larger than that of the channel counting the number of pulses per second for the computation channel that is to calculate the number of pulses per minute.

- **Example 3: Reset When the Pulse Sum Value Exceeds a Certain Value**

Reset the sum value when the pulse sum value exceeds a specified value (reset value) and carry over the value exceeding the reset value to the sum after the reset. Count the number of resets and calculate the total sum value up to that point.

Expression

Assign expressions to the computation channels as shown below and set the constants.

Channel	Expression	Application
101	((102+P01).GE.K01)+101	Pulse sum value reset count
102	CARRY(K01):TLOG.SUM(P01)	Pulse sum value
103	K01*101+102	Total sum value

Symbol	Description
P01	Counts the number of pulses per scan interval.
K01	Constant. The reset value. The sum value is reset when this value is exceeded.

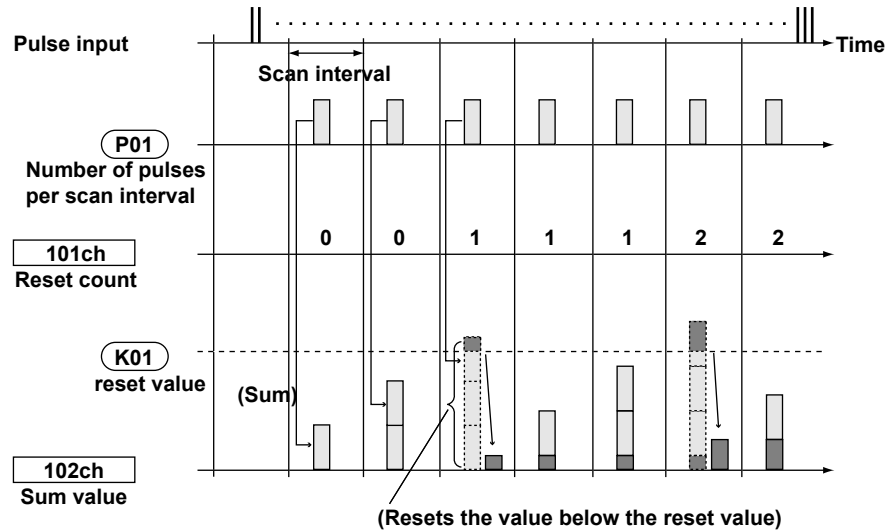

Channel 101: Reset Count

Calculates the number of times the pulse sum value is reset.

The expression “((102+P01).GE.K01)” is set to 1 when “the previous pulse sum value (102) + the current pulse count (P01)” is greater than the reset value (K01). Otherwise, the expression is set to 0. The value of channel 101 is incremented when the pulse sum value exceeds the reset value.

Channel 102: Pulse Sum Value

Calculates the pulse sum value.

Under normal conditions, the pulse sum value TLOG.SUM (P01) is calculated. When the pulse sum value is greater than or equal to the reset value (K01), the pulse sum value is set to the amount exceeding K01.

Channel 103: Total Sum Value

Multiplies the reset value (K01) by the reset count (101) and adds the pulse sum value (102) to derive the total sum value.

Note

- The computation is performed in order from the channel with the smallest channel number in one scan interval. If the channel number in the expression is greater than or equal to the channel number in which the expression is assigned, the previous computed result (previous value) is used for the channel in the expression.
- If the pulse input value of the scan interval is greater than the reset value, correct computation cannot be achieved.

3.11 Setting the Method of Detecting Over-Range Values of Linearly Scaled Measurement Channels

Setup Screen

Press **MENU** (to switch to setting mode), hold down **FUNC** for 3 s (to switch to basic setting mode), and select the **Environment** tab > **Input, Tag**.

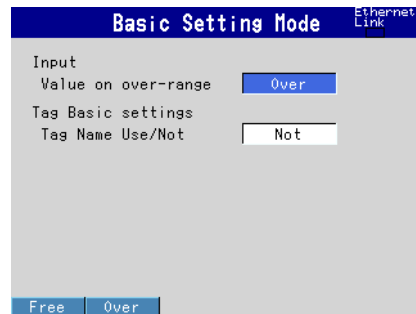

Setup Items

- **Input > Value on over-range**

Settings	Description
Free	The value is set to –over range if the value is less than –30000 and +over range if the value is greater than 30000 excluding the decimal point. The value is displayed as –Over and +Over, respectively.
Over	The value is set to –over range if the value is less than –5% of the scale and +over range if the value is greater than 105%. The value is displayed as –Over and +Over, respectively. Example: If the scale is 0.0 to 200.0, the value is set to –over range if the value is less than –10.0 of the scale and +over range if the value is greater than 210.0.

Note

For computations such as TLOG, CLOG, and report, the handling of the scale over-range value can be set in advance.

See section 9.1.

3.12 Using the Alarm Annunciator Function (Release number 3 or later)

This section explains how to use the alarm annunciator function.
For a description of the function, see section 1.2.

Setup Screen

- **Annunciator Mode**

Press **MENU** (to switch to setting mode), hold down **FUNC** for 3 s (to switch to basic setting mode), and select the **Environment** tab > **Alarm** > **Action**.

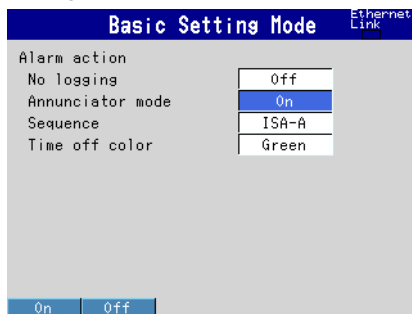

- **Alarm Levels and Colors**

See section 3.7.

- **Display**

Press **MENU** (to switch to setting mode), and select the **Menu** tab > **Display** > **Annunciator**.

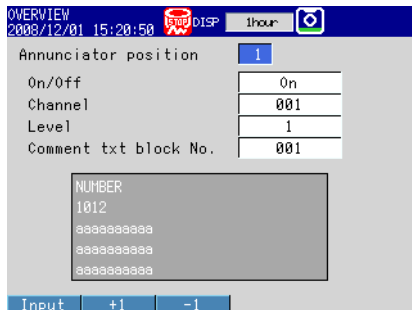

Setup Items

- **Alarm action > Annunciator mode**
Select **On** to use the annunciator function.

- **Alarm action > Sequence**

Select the annunciator sequence. For details about the annunciator sequence, see "Explanation" in this section.

Setting	Description
ISA-A-4	A no lock-in sequence.
ISA-A	A lock-in sequence.
ISA-M	A double lock-in sequence.

3.12 Using the Alarm Annunciator Function (Release number 3 or later)

- **Alarm action > Time off color**
The window display color when no alarms are activated. You can select white or green.
- **Levels and Colors**
See section 3.7.
- **Annunciator position**
The position of the annunciator window. See the explanation for the next item.
- **Annunciator position > On/Off**
Set the annunciator position that you want to use to **On**.
Starting with 1, consecutively set all annunciator positions that you want to use to On. After a position has been set to Off, all of the positions after it will also be turned off even if they are set to On. The annunciator display changes depending on how many annunciator windows you use. For details, see "Explanation."
- **Annunciator position > Channel, Level**
You can assign alarms to annunciator windows by specifying channel numbers and alarm levels.
You can set Level to 1, 2, 3, 4, or All. If you select All, all of the alarms in the specified channel are assigned to the specified window.
- **Annunciator position > Comment txt block No.**
You can select a text string (label) to display in the annunciator window by selecting a comment text block number.
For information about how to set comment text blocks, see section 5.18.

Procedure

• **Opening the Display**

The annunciator display appears when you turn on the power. You can switch to the annunciator display from other displays by following the procedure below.

1. Press **DISP/ENTER** to show the display selection menu.
2. Use the **up and down arrow keys** to select **Annunciator**, and then press **DISP/ENTER**.

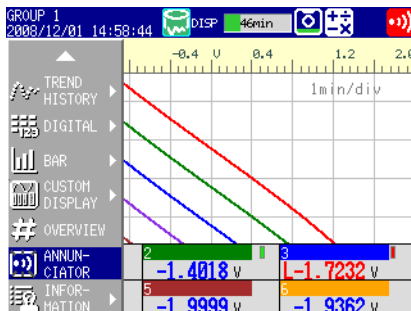

The display appears. The example below is for when there are four annunciator windows.

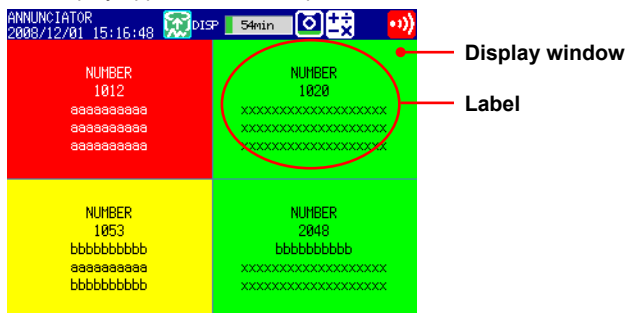

• **Alarm ACK**

Perform this operation after an alarm has occurred. This operation affects all alarms.

1. In operation mode, press **FUNC**.
The FUNC key menu appears.
2. Press the **AlarmACK** soft key.
The alarm indications and outputs are cleared according to the annunciator sequence. For details, see "Explanation."

• **Alarm Display Reset (When the annunciator sequence is set to ISA-M)**

The alarm display reset operation will not take place unless the alarm ACK operation is performed first. The alarm display reset operation affects all alarms.

1. In operation mode, press **FUNC**.
The FUNC key menu appears.
2. Press the **AlarmDispRST** soft key.
The alarm displays are reset. They are reset according to the annunciator sequence. For details, see "Explanation."

3.12 Using the Alarm Annunciator Function (Release number 3 or later)

Explanation

- **Display Window Layouts and Labels**

The annunciator display layouts and labels change as indicated in the table below.

Displayed Windows	Window Layout Vertical × Horizontal	Labels (max number of displayable characters)		Font Size
		Lines	Characters	
4	2 × 2	5	26	6
6	3 × 2	5	26	6
8	4 × 2	4	26	6
10	5 × 2	3	26	6
12	6 × 2	3	26	6
16	8 × 2	2	26	6
20	5 × 4	3	13	6
24	8 × 3	2	17	6

Display Positions

Annunciator windows are assigned to positions starting with the left column.

Annunciator windows are assigned in ascending order. The example below is for an annunciator display with eight windows.

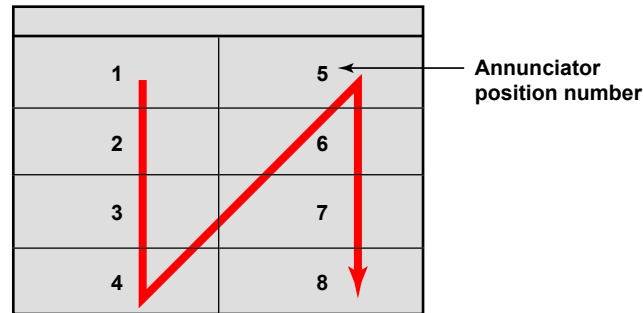

Labels

The number of characters that can be displayed varies depending on the number of annunciator windows.

- **Window Colors**

State	Color
When an alarm is released	"Time off color" (green or white)
When an alarm is occurring	The alarm color. If multiple alarms are occurring, the window is displayed using the color of the alarm with the highest priority.
Displayed windows not in use	Gray

• Annunciator Sequence

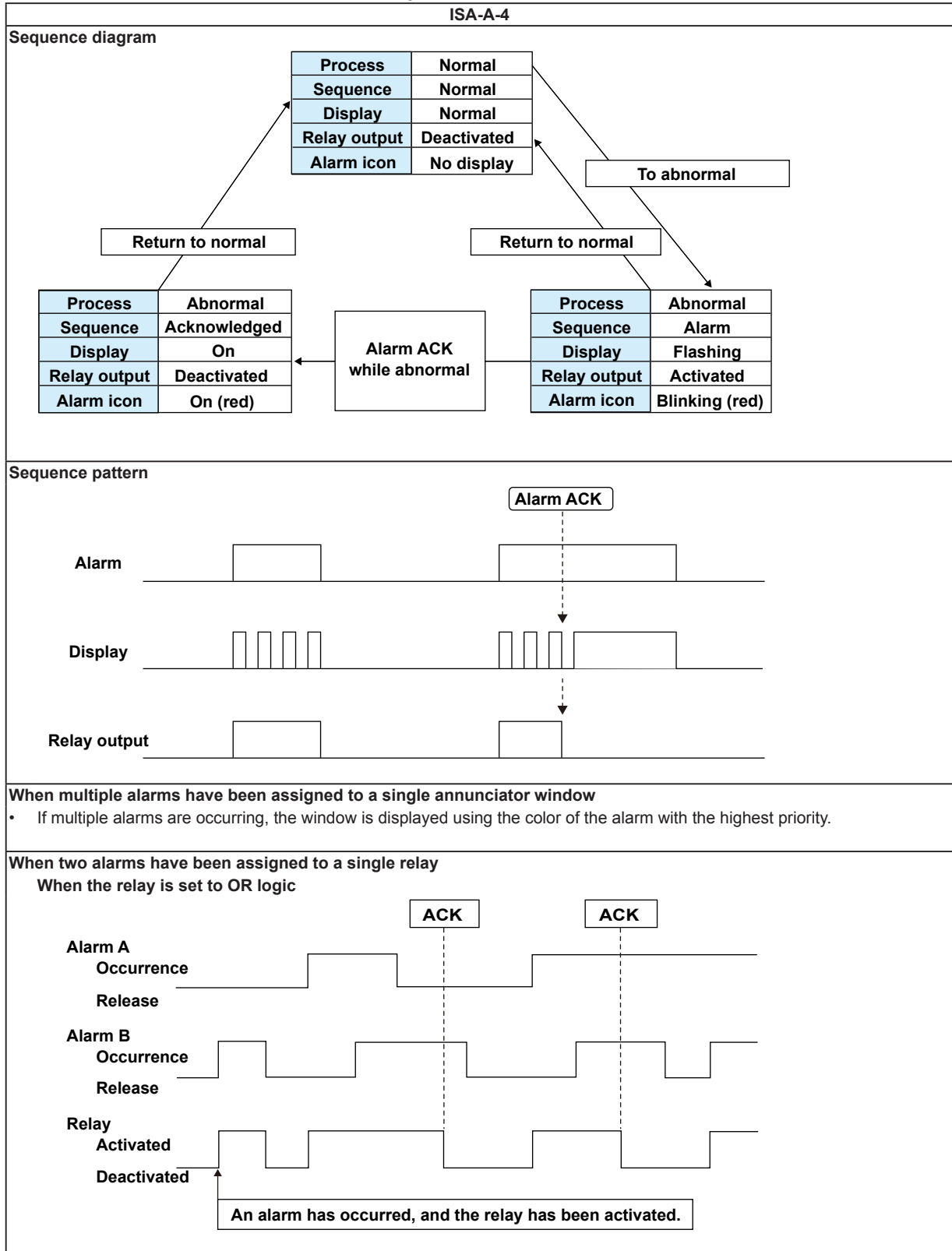

3.12 Using the Alarm Annunciator Function (Release number 3 or later)

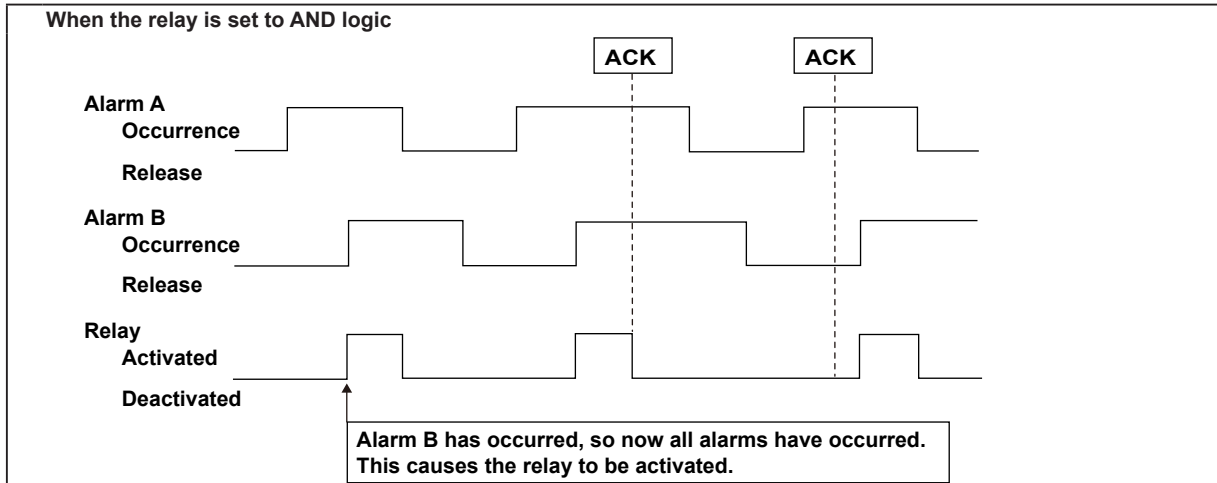

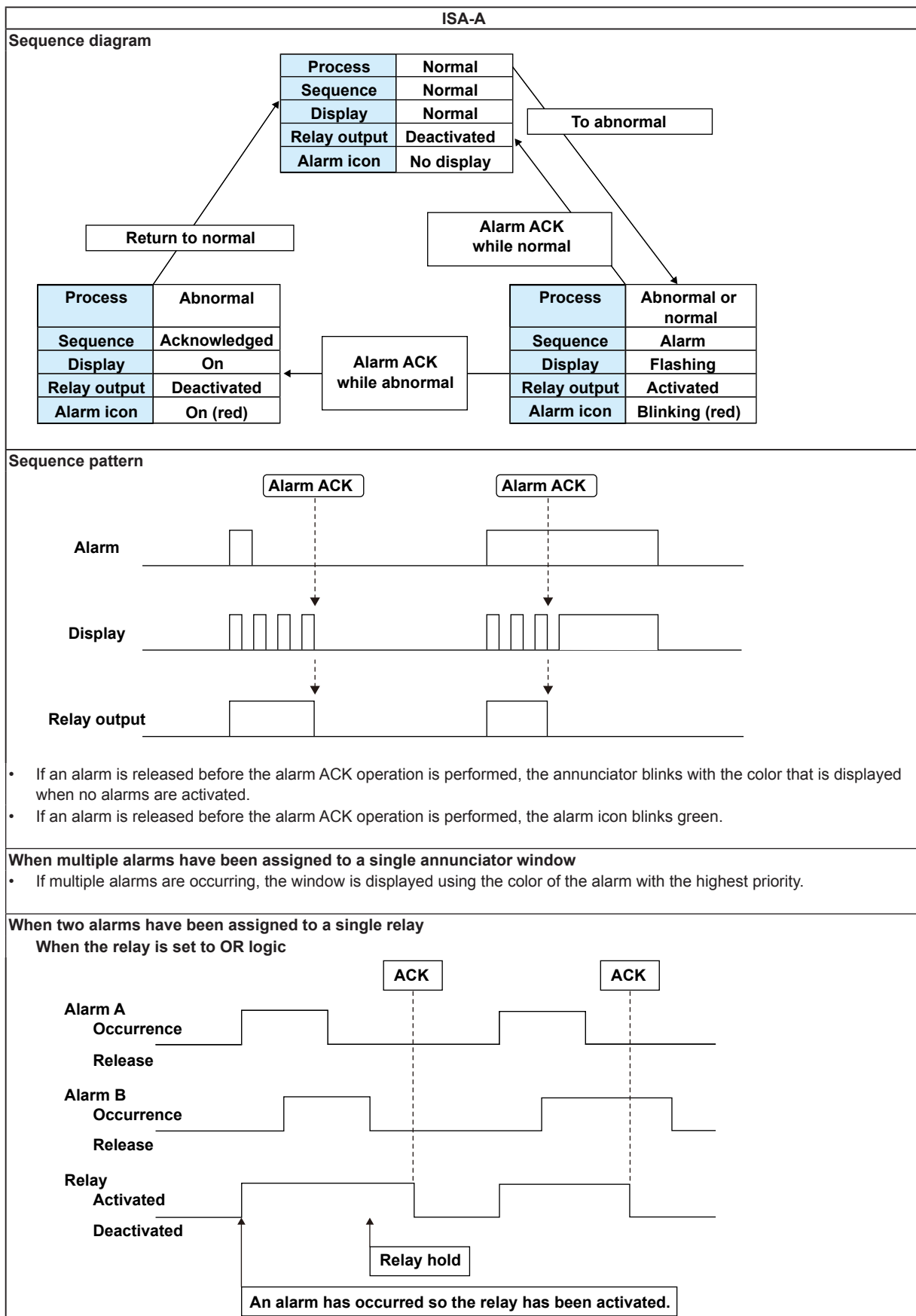

3.12 Using the Alarm Annunciator Function (Release number 3 or later)

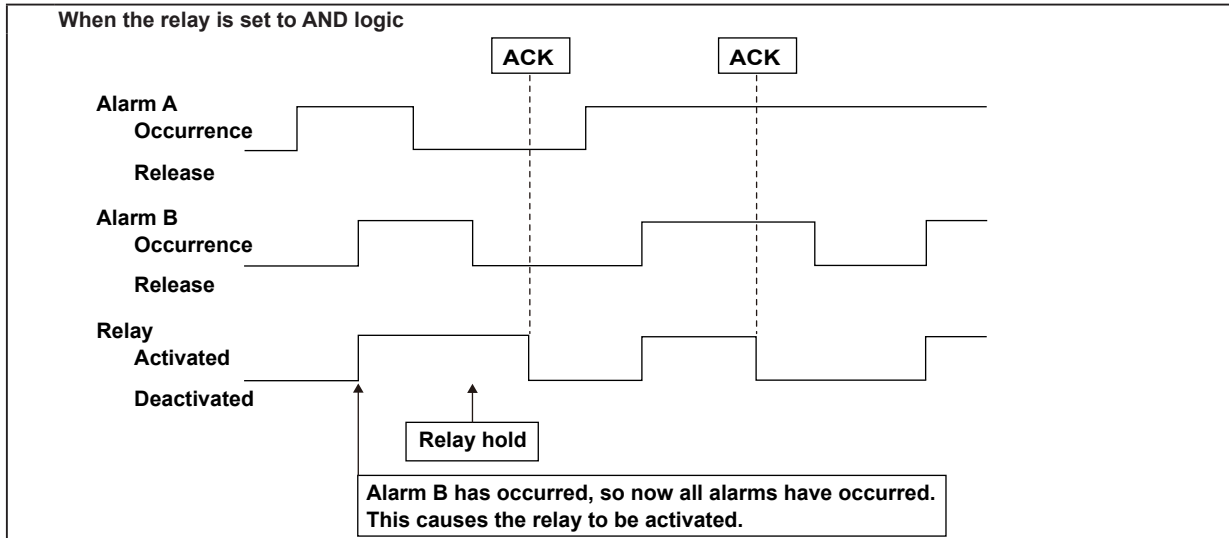

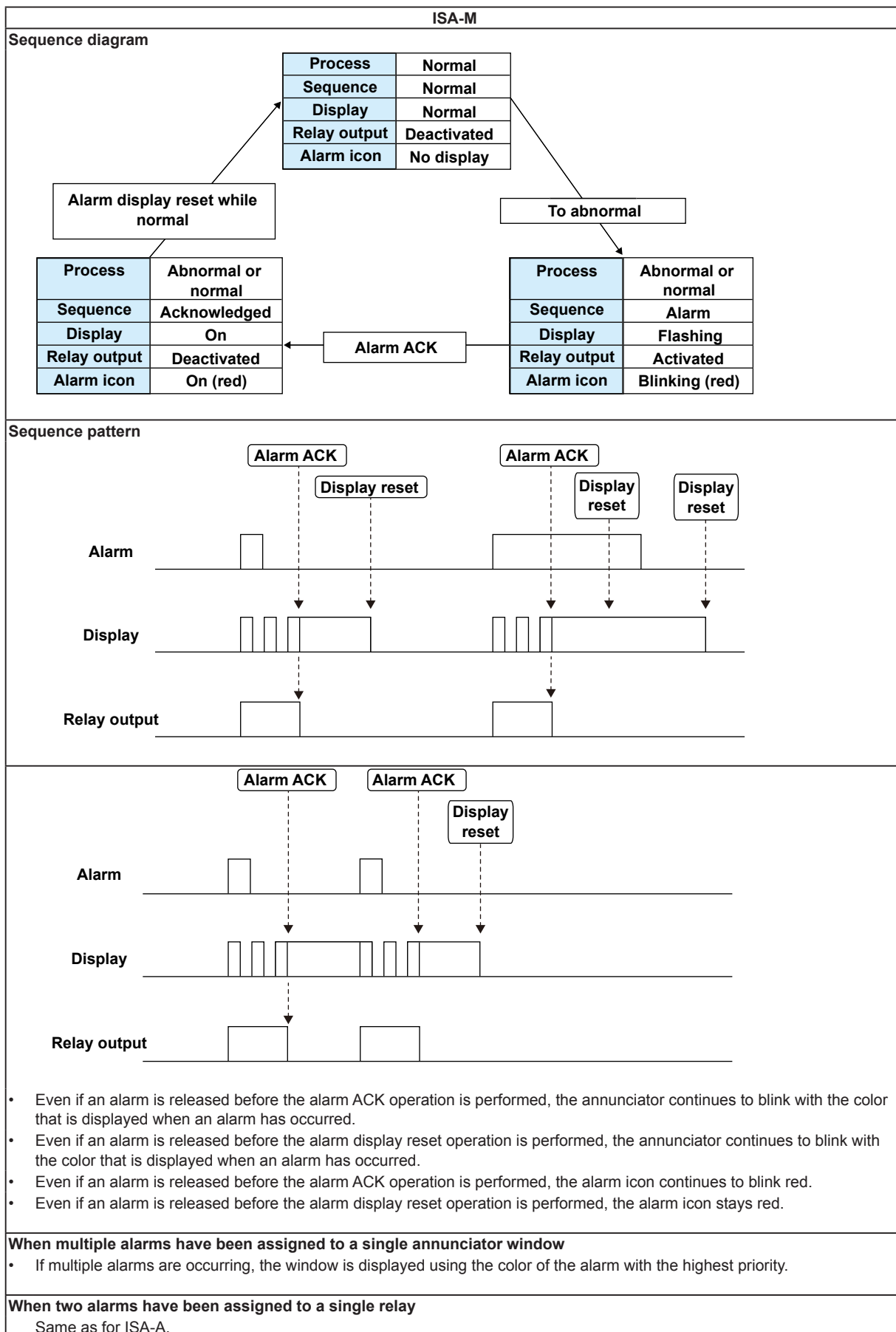

3.13 Managing the Input Calibration Interval (/CC1 option; release numbers 4 and later)

Manage the input calibration interval to make sure that calibration is performed regularly. For a description of the function, see section 1.1.

Setup Screen

Press **MENU** (to switch to setting mode), hold down **FUNC** for 3 s (to switch to basic setting mode), and select the **Menu** tab > **Set Calibration**.

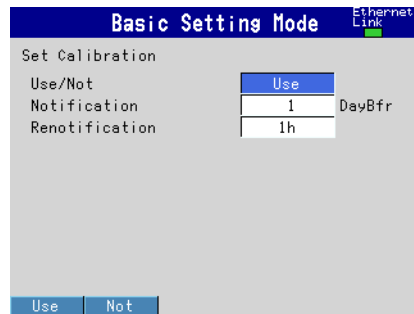

Setup Items

- **Set Calibration > Use/Not**
Select whether to **Use** or **Not** use calibration management.
When you select Use, the Set Calibration tab appears in setting mode.
- **Set Calibration > Notification (DayBfr)**
You can specify how many days before the calibration due date you want to display the calibration notification screen. You can set the number of days to a value between 1 and 10.
- **Set Calibration > Renotification**
You can specify the period at which to display the calibration notification screen. The calibration notification screen will continue to appear until calibration is completed.

Setting	Description
10min	The screen will appear every 10 minutes.
30min	The screen will appear every 30 minutes.
1h	The screen will appear every hour.
8h	The screen will appear every 8 hours.
24h	The screen will appear every 24 hours.

Procedure

• **Viewing the Calibration Notification Screen**

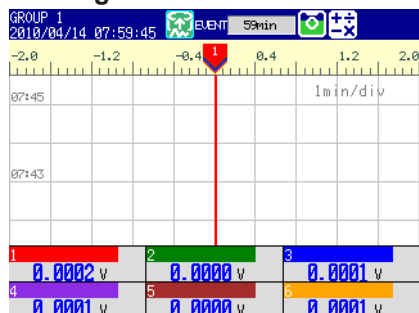

The calibration notification screen only appears over operation screens. It will continue to appear until you perform calibration (Finish Calibration).

You can close the calibration notification screen by pressing **ESC** or **DISP/ENTER**.

Operation Example

When Notification is set to 1 (DayBfr) and Renotification is set to 8h

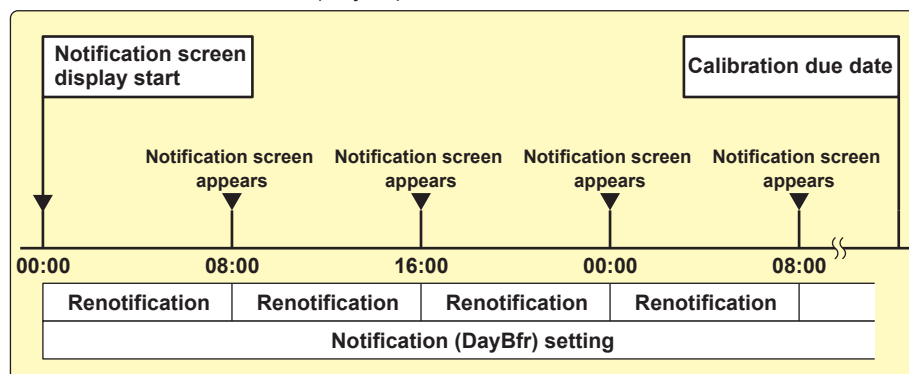

Note

- The calibration notification screen will close if you change screens while it is displayed.
- If the calibration due date passes before you complete calibration, that information will be recorded in the login log (the operation log on DXs with the /AS1 option).

3.13 Managing the Input Calibration Interval (/CC1 option; release numbers 4 and later)

- **Checking the Calibration Due Date**

Carry out the procedure below to show the display.

Press **MENU** (to switch to setting mode) > **Set Calibration** tab.

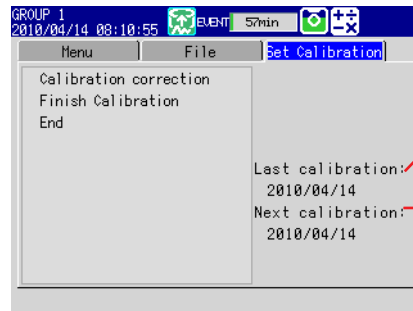

The date on which the last calibration was completed
Displayed according to the date format
(see section 2.4)

Due date for next calibration
Displayed according to the date format (see section 2.4)

- **Configuring Calibration**

Carry out the procedure below to show the display.

Press **MENU** (to switch to setting mode) > **Set Calibration** tab > **Calibration Correction**.

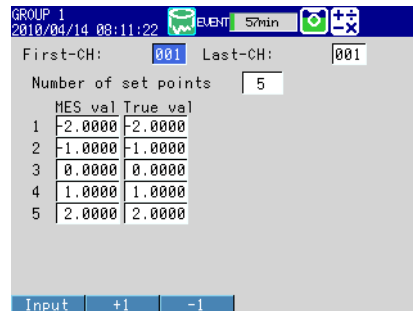

The setup items are the same as in section 3.9, "Performing Calibration Correction."

For the setting procedure, see section 3.9.

• **Finishing Calibration**

Set the next calibration due date.

1. Carry out the procedure below to show the display.

Press **MENU** (to switch to setting mode) > **Set Calibration** tab > **Finish Calibration**.

A window for setting the calibration due date appears.

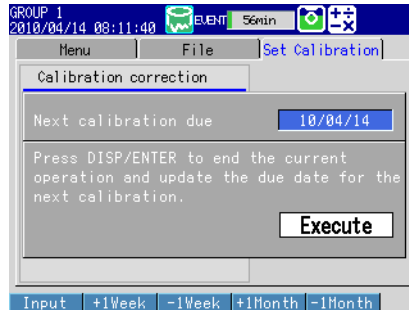

2. Set the next calibration due date, and press **DISP/ENTER**.

Soft Key	Description
Input	Enter the date directly.
+1 Week	Set the date by adding weeks to the current calibration due date.
-1 Week	Set the date by subtracting weeks from the current calibration due date.
+1 Month	Set the date by adding months to the current calibration due date.
-1 Month	Set the date by subtracting months from the current calibration due date.

3. Use the **arrow keys** to select **Execute**, and press **DISP/ENTER**.
Calibration is complete.

Note

- You cannot set the calibration due date to a date before the current day.
- Whenever you complete calibration, a log is added to the login log (the operation log on DXs with the /AS1 option).

4.1 Operations in Operation Mode

Switching the Screen with the DISP/ENTER Key and Arrow Keys

Press **DISP/ENTER** and **arrow keys** to show the display selection menu and sub menu to switch the display. The flow of operation is indicated below.

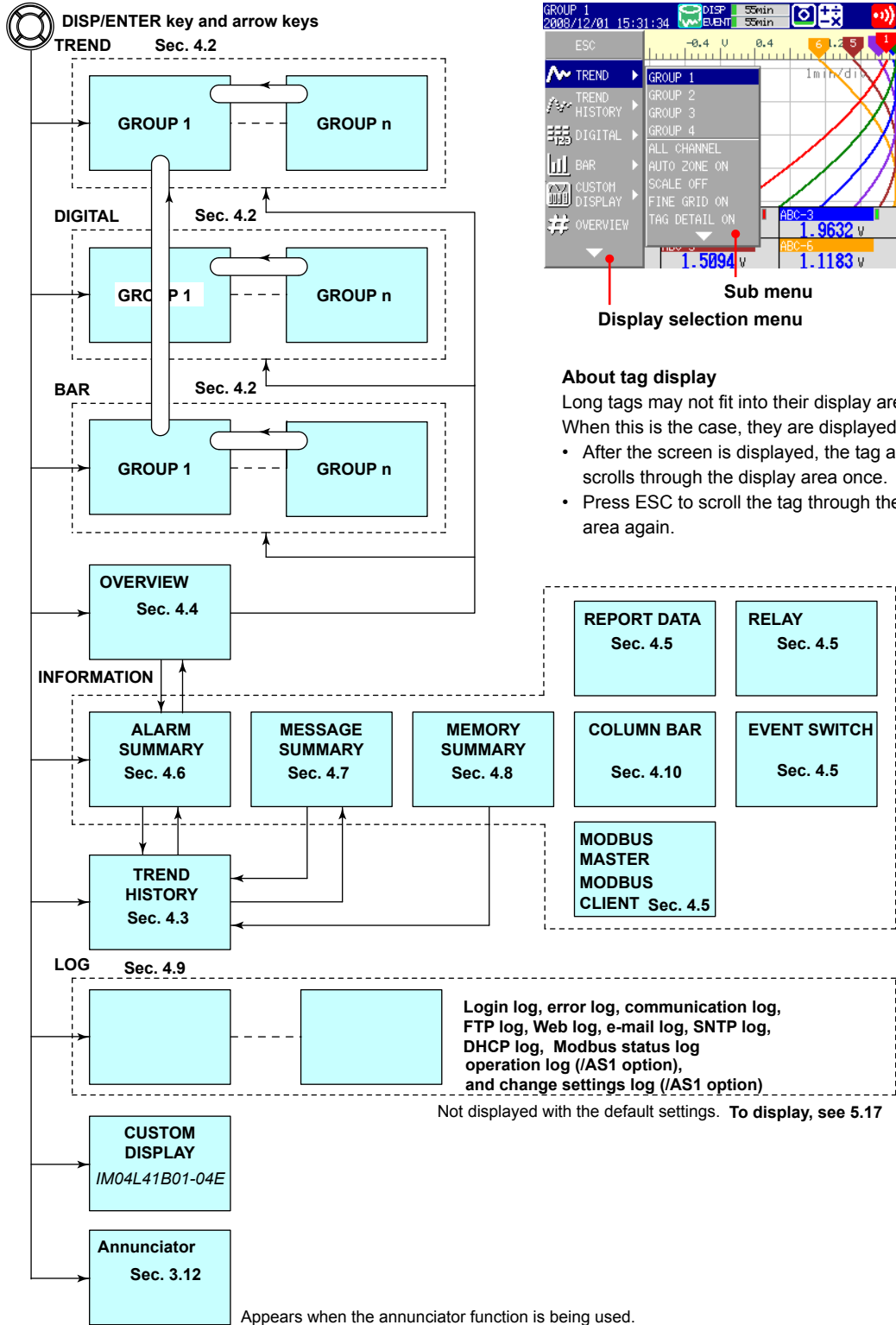

About tag display

Long tags may not fit into their display areas. When this is the case, they are displayed as follows:

- After the screen is displayed, the tag automatically scrolls through the display area once.
- Press ESC to scroll the tag through the display area again.

Operations Using Other Keys

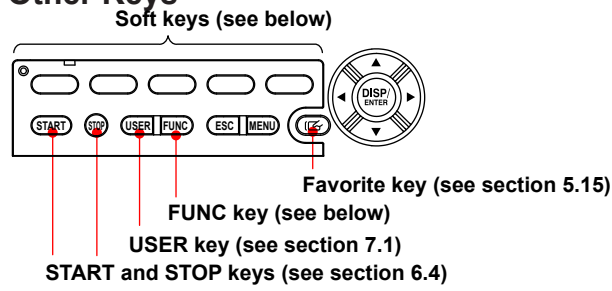

Operation Using the FUNC Key

Press **FUNC** to display the FUNC key menu at the bottom of the screen. Press the **Next** soft key to switch the menu. Press the desired **soft key**.

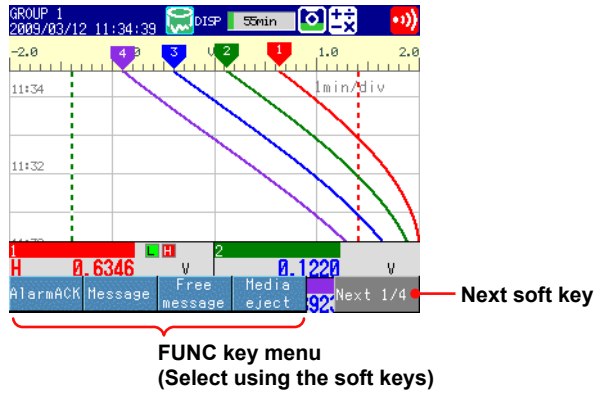

Menu Item	Refer to
Alarm ACK	Section 3.8
Alarm DispRST	Section 3.12
Message	Section 5.4
Free message	Section 5.4
Media eject	Sections 6.4 and 2.12
Snap shot	Section 6.6
Manual sample	Section 6.5
Trigger	Section 6.4
Save display	Section 6.4
Save event	Section 6.4
Save stop	Section 4.8
Math start/stop	Section 9.4
Math reset	Section 9.4
Math ACK	Section 9.4
Edge Switch	Section 7.1
Timer reset	Section 7.1
Match T Reset	Section 7.1
Keylock	Section 8.1
Logout	Section 8.3
Locked ACK	IM04L41B01-05EN
Password change	Section 8.3
Normal speed/Second speed	Section 5.3
Batch	Section 6.3
Text field	Section 6.3
Builder	IM04L41B01-04
Favorite regist	Section 5.15
Standard display	Section 5.14
System info	Section 2.5
Network info	Section 2.5
SNTP	IM04L41B01-17E
E-Mail start/stop	IM04L41B01-17E
E-Mail test	IM04L41B01-17E
FTP test	IM04L41B01-17E

Customizing the Menus

The display selection menu that appears when the **DISP/ENTER** key is pressed and the **FUNC** key menu that appears when the **FUNC** key is pressed can be changed. See section 5.17.

4.2 Displaying the Measured Data as Waveforms, Values, or Bar Graphs

This section explains how to use the trend, digital, and bar graph displays. For a description of the function, see section 1.3.

Procedure

- **Showing the Display**

1. Press **DISP/ENTER** to show the display selection menu.
2. Press the **arrow keys** to select **TREND**, **DIGITAL**, or **BAR**, and press **DISP/ENTER**.

The selected display appears.

- **Changing the Displayed Contents**

1. Press **DISP/ENTER** to show the display selection menu.
2. Press the **right arrow key** to display the sub menu.
3. Press the **up and down arrow keys** to select the sub menu item.

Trend display sub menu

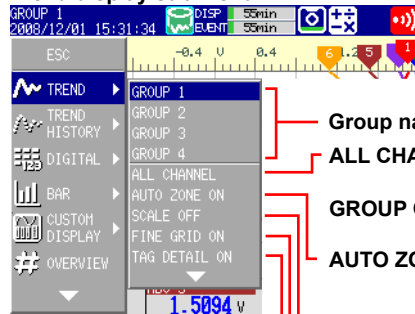

- Group name:** Displays the group
- ALL CHANNEL:** Displays the waveforms of all channels
- GROUP CHANNEL:** Displays the waveforms of the channels registered to groups
- AUTO ZONE ON:** Displays trend waveforms separately by assigning each channel in the group to separate display areas (zones)
- AUTO ZONE OFF:** Does not display waveforms in zones
- SCALE ON:** Displays the scale
- SCALE OFF:** Clears the scale
- FINE GRID ON:** Displays the fine grid
- FINE GRID OFF:** Clears the fine grid
- TAG DETAIL ON:** When a tag does not fit into the typical tag display space, the alarm and measured values are covered so that the tag can be displayed completely.
- TAG DETAIL OFF:** Priority is not given to tag display
- DIGITAL OFF:** Clears the numeric display section
- DIGITAL ON:** Displays the numeric display section
- MESSAGE DISP1:** Displays the messages using display method 1
- MESSAGE DISP2:** Displays the messages using display method 2
- TREND SPACE ON:** Inserts a space at the right edge (horizontal display) or the top edge (vertical display) in the waveform display area
- TREND SPACE OFF:** Does not insert a space (Not displayed with the default settings. To display, see section 5.17.)
- AUTO SCROLL ON:** Automatically switches the displayed groups
- AUTO SCROLL OFF:** Does not automatically switch the displayed groups



Digital display sub menu

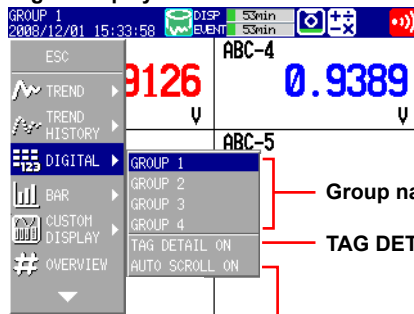

- Group name:** Displays the group
- TAG DETAIL ON:** When a tag does not fit into the typical tag display space, the alarm and measured values are covered so that the tag can be displayed completely.
- TAG DETAIL OFF:** Priority is not given to tag display.
- AUTO SCROLL ON:** Automatically switches the displayed groups
- AUTO SCROLL OFF:** Does not automatically switch the displayed groups

Bar graph display sub menu

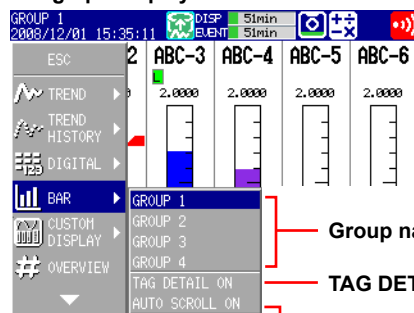

- Group name:** Displays the group
- TAG DETAIL ON:** When a tag does not fit into the typical tag display space, the alarm and measured values are covered so that the tag can be displayed completely.
- TAG DETAIL OFF:** Priority is not given to tag display.
- AUTO SCROLL ON:** Automatically switches the displayed groups
- AUTO SCROLL OFF:** Does not automatically switch the displayed groups

4. Press **DISP/ENTER** to change the displayed contents.
To close the menu without changing the displayed contents, press the **ESC** key.

- **Starting the Waveform Display of the Trend Display/Stopping the Waveform Updating**
Press **START** to start the waveform display of the trend display. Press **STOP** to stop the waveform updating.
- **Writing Messages**
See section 5.4.
- **Switching the Displayed Group Using Arrow Keys**
Press the **right arrow key** to switch the displayed group in ascending order. Press the **left arrow key** to switch the displayed group in reverse.
- **Switching the Trend, Digital, and Bar Graph Displays Using the Arrow Keys**
Press the **down arrow key** while showing the trend, digital, or bar graph display to switch the display in the order trend, digital, bar graph, trend, and so on. Press the **up arrow key** to switch the display in reverse order.

Explanation

- ALL CHANNEL/GROUP CHANNEL on the Trend Display**
 On the group display, the channels that are assigned to the group are displayed. In all channel display, the waveforms of all channels that are configured to record data are displayed on the current group display. The waveforms of channels that are not assigned to the group are displayed in the waveform display area, but the scales, current value marks, and digital values of the channels are not displayed.
- SCALE ON/OFF and DIGITAL ON/OFF on the Trend Display**
 Select whether to show or hide the scale and numeric display sections.
- AUTO SCROLL ON/OFF**
 The displayed groups can be automatically switched at a specified interval by selecting **AUTO SCROLL ON**. The display switches in ascending group order. For the procedure to set the auto scroll interval of groups, see section 5.13.
- MESSAGE DISP 1 and MESSAGE DISP 2 on the Trend Display**
 Switches the message display method.
- AUTO ZONE (Release number 3 or later)**
 Displays trend waveforms separately by evenly dividing display areas (zones) among a group's channels.

With AUTO ZONE OFF

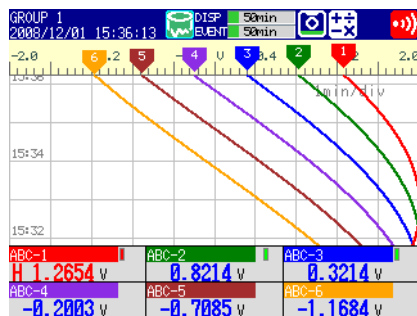

With AUTO ZONE ON

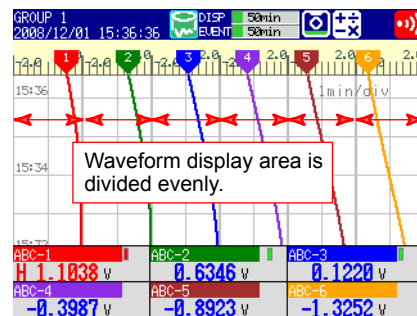

- FINE GRID (Release number 3 or later)**
 Display the fine grid when the normal grid is too wide for reading measured values. The fine grid can be used in the trend and historical trend displays. The fine grid places an additional four lines between the normal grid lines.

With FINE GRID OFF

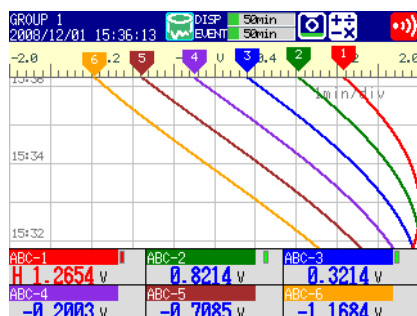

With FINE GRID ON

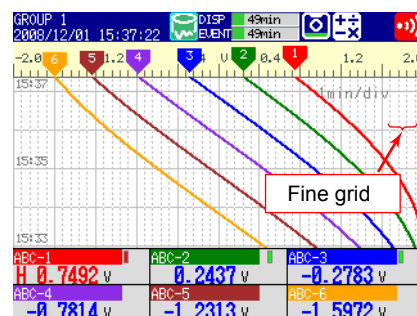

• **TAG DETAIL ON/OFF (Release number 3 or later)**

When TAG DETAIL is set to ON and a tag does not fit into the typical tag display space, it covers the alarm and measured values so that it can be displayed completely. Depending on display space limitations, it may not be possible to display the entire tag. If the tag comment and number do not fit within a display area, they can be scrolled. The TAG DETAIL setting made in one display affects the settings in all of the other displays.

The figure below shows an example for when six channels are being displayed.

When the Tag Number Is Not Displayed

If TAG DETAIL is on, the tag comment is displayed as much as possible.

With TAG DETAIL OFF

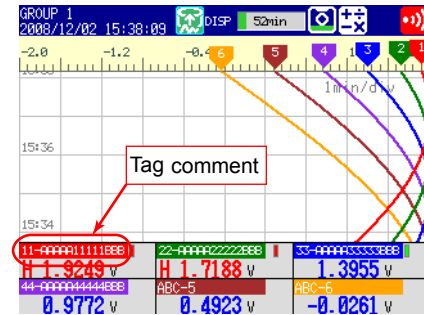

With TAG DETAIL ON

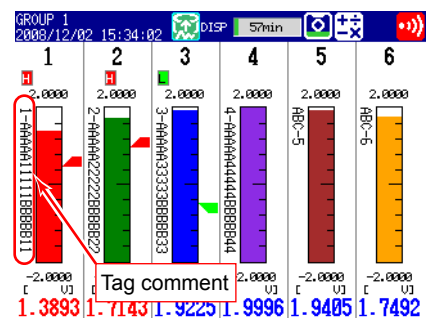
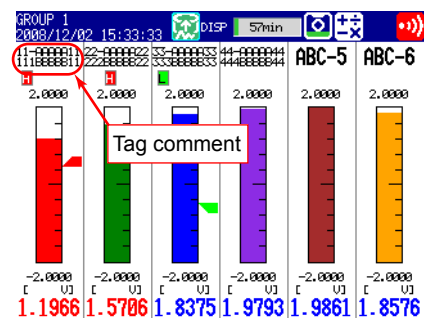
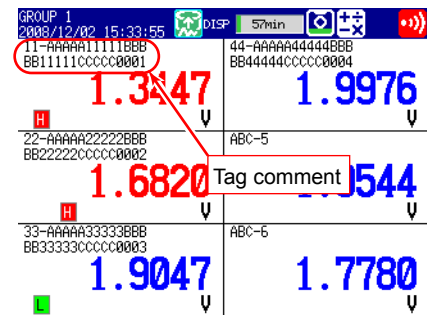
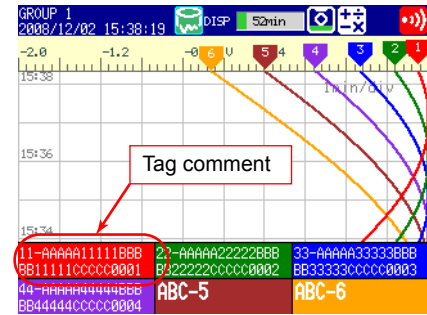

4.2 Displaying the Measured Data as Waveforms, Values, or Bar Graphs

When the Tag Number Is Displayed

When TAG DETAIL is set to off, display priority is given to the tag number. If TAG DETAIL is on, the tag number and comment are displayed as much as possible.

With TAG DETAIL OFF



With TAG DETAIL ON

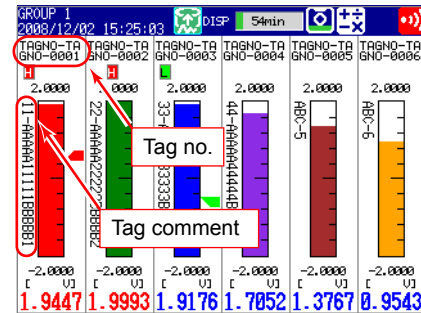
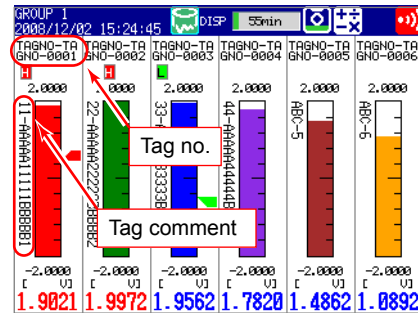
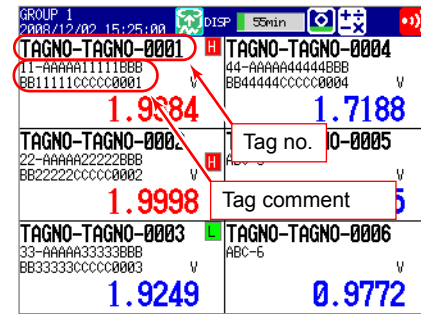
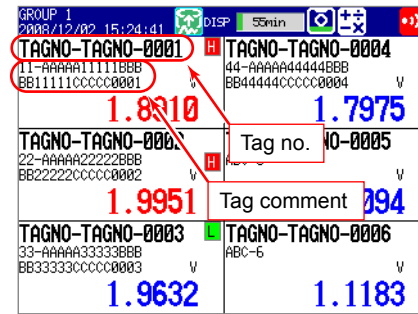
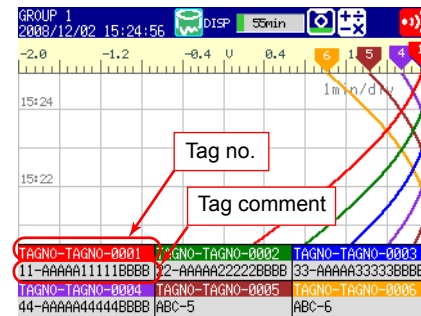

In the above digital value display example, because there is enough space for the tags, the display does not change whether TAG DETAIL is on or off.

In the above bar graph display example, because space is limited, the display does not change whether TAG DETAIL is on or off.

• TREND SPACE ON/OFF

With TREND SPACE ON

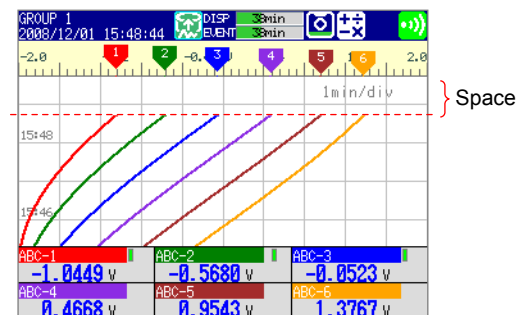

4.3 Displaying Past Measured Data (Historical Trend Display)

There are five methods to display the past measured data.

For a description of the function, see section 1.3.

Recall from the display selection menu (see this section).

Display from the alarm summary (see section 4.6).

Display from the message summary (see section 4.7).

Display from the memory summary (see section 4.8).

Show the measured data stored on an external storage medium (see section 6.8).

Procedure

• Showing the Display

Carry out the procedure below while memory sampling is in progress.

1. Press **DISP/ENTER** to show the display selection menu.
2. Press the **arrow keys** to select **TREND HISTORY**, and press **DISP/ENTER**. The display appears.

• Changing the Displayed Contents

1. Press **DISP/ENTER** to show the display selection menu.
2. Press the **right arrow key** to display the sub menu.
3. Press the **up and down arrow keys** to select the sub menu item.

Historical trend display sub menu

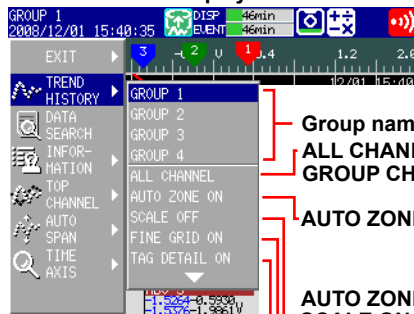

- Group name:** Displays the group
- ALL CHANNEL:** Displays the waveforms of all channels
- GROUP CHANNEL:** Displays the waveforms of the channels registered to groups
- AUTO ZONE ON:** Displays trend waveforms separately by assigning each channel in the group to separate display areas (zones)
- AUTO ZONE OFF:** Does not display waveforms in zones
- SCALE ON:** Displays the scale
- SCALE OFF:** Clears the scale
- FINE GRID ON:** Displays the fine grid
- FINE GRID OFF:** Clears the fine grid
- TAG DETAIL ON:** When a tag does not fit into the typical tag display space, the alarm and measured values are covered so that the tag can be displayed completely.

- TAG DETAIL OFF:** Priority is not given to tag display.
- MESSAGE DISP2:** Displays the messages using display method 2
- MESSAGE DISP1:** Displays the messages using display method 1
- CURSOR VALUE:** With display data, shows the maximum data value at the cursor position. With event data, shows the data at the cursor position.
- DIGITAL MAX/MIN:** Displays the maximum and minimum values at the cursor position and the maximum and minimum values within the displayed data in the digital value display area
- CURSOR TIME ON:** Shows the time at the cursor position in the top right of the display
- CURSOR TIME OFF:** Displays the date/time of the data at the right edge of the screen
- RELATIVE TIME:** Displays the time that has elapsed since memory start
- ABSOLUTE TIME:** Displays the time when data was recorded

4.3 Displaying Past Measured Data (Historical Trend Display)

Historical trend display sub menu

The screenshots show the following menu interactions:

- Screenshot 1:** The 'TREND' menu is open, showing options like 'DIGITAL', 'BAR', and 'TRENDS'. Annotations indicate that 'TREND' switches to the specified display and 'TRENDS' returns to the display shown before the historical trend.
- Screenshot 2:** The 'INFORMATION' menu is open, showing 'ALARM SUMMARY', 'MESSAGE SUMMARY', and 'INFORMATION'. Annotations indicate that 'ALARM SUMMARY' displays the alarm summary, 'MESSAGE SUMMARY' displays the message summary, and 'INFORMATION' displays information about the loaded data file.
- Screenshot 3:** The 'TOP CHANNEL' menu is open, listing channels ABC-1 through ABC-6. An annotation indicates that this menu displays the trend waveform and scale markers of the selected channel in front of all others.
- Screenshot 4:** The 'AUTO SPAN' menu is open, listing channels ABC-1 through ABC-6 and an 'OFF' option. An annotation indicates that this menu adjusts the display span of the selected channel, with 'OFF' returning to the original span.
- Screenshot 5:** The 'TIME AXIS' menu is open, showing 'ZOOM +', 'ZOOM -', and 'TRENDS'. An annotation indicates that this menu expands or reduces the time axis.

4.3 Displaying Past Measured Data (Historical Trend Display)

Sub menu when the alarm summary is being displayed

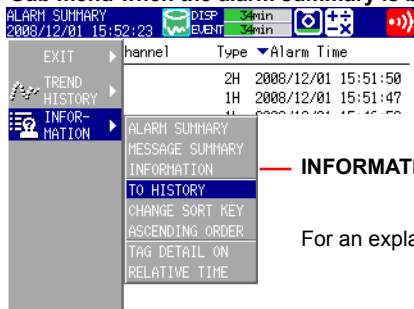

INFORMATION: Shows information about the measured data that is currently displayed

For an explanation of the other menu items, see section 4.6.

Sub menu when the message summary is being displayed

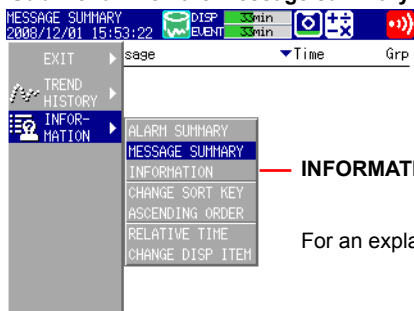

INFORMATION: Shows information about the measured data that is currently displayed

For an explanation of the other menu items, see section 4.7.

4. Press **DISP/ENTER** to change the displayed contents.
To close the menu without changing the displayed contents, press the **ESC** key.

4.3 Displaying Past Measured Data (Historical Trend Display)

- **Moving the Cursor and Scrolling the Waveform**

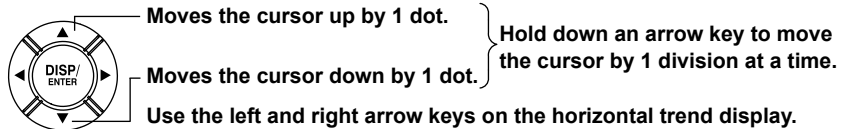
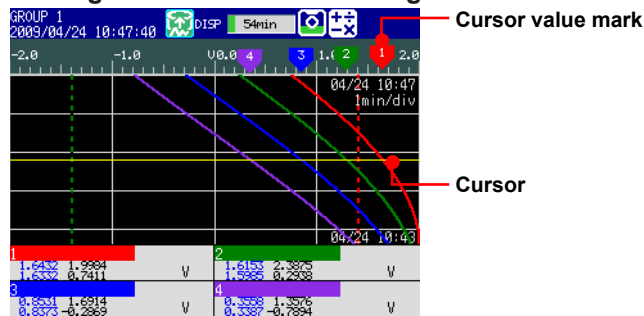

- **Displaying the Continuing Data**

Approximately one screen of data is shown on the historical trend display. The continuing data can be shown as follows:

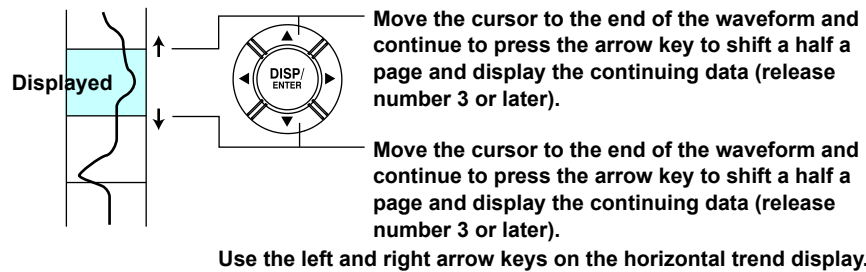

- **Specifying the Display Range**

Specify the display range. Items inside the parentheses are for the horizontal trend display.

* When you clear the scale (see page 4-9), the screen switching icons appear in its place.

1. Press the **right (up) arrow key**.

The waveform of the entire data range is displayed at the right (top) section of the screen.

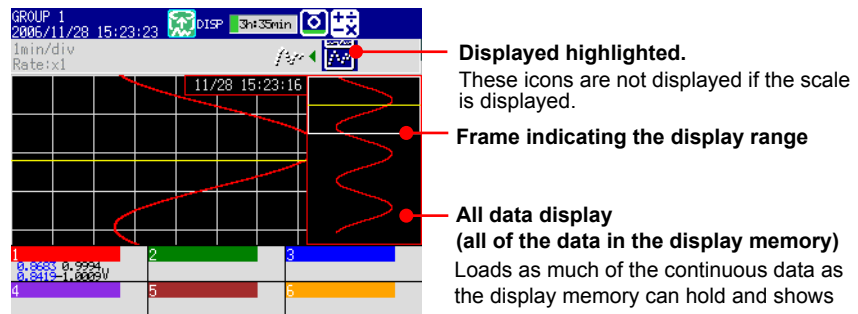

2. Press the **up and down (left and right) arrow keys** to set the display position by moving the frame that indicates the display range. If you hold down one of the arrow keys, the frame that indicates the display range will move continuously in the direction of the arrow that you hold down.

3. Press the **left (down) arrow key**.

The specified range is displayed.

- **If the Data Does Not Fit in the All Data Display (Release Number 2 or Later)**
Specify the range to be displayed in the all data display.
Below is the procedure to display data that is older than the data displayed currently.
Items inside the parentheses are for the horizontal trend display.

1. Press the **right (up) arrow key**.

The waveform of all the data in the display memory is displayed at the right (top) of the screen. At the same time, the data area in the internal memory that can be loaded is displayed. In addition, the data position of 8 MB that is displayed in the all data display is indicated using a rectangular frame in the loadable data area.

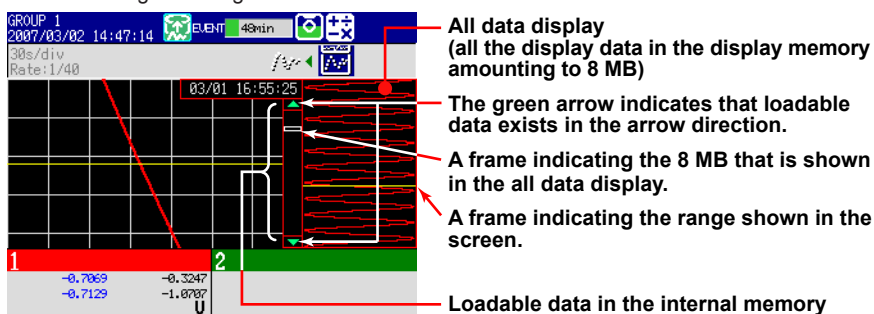

2. Press the **down (left) arrow key** to move the frame indicating the display range to the edge of the all data display. If you press the **down (left) arrow key** again, the message “Overwrite old data?” appears.
3. Select Yes and press **DISP/ENTER** to replace 4 MB of data in the display memory.
4. Press the **up/down (left/right) arrow key** to move the frame indicating the display range to specify the range you want to display.
5. Press the **left (down) arrow key**.
The specified range is displayed.

- **Dividing the Screen into Halves and Displaying the Current Trend and Historical Trend Simultaneously**

This operation is possible only when the historical trend of the display data is being displayed. Items inside the parentheses are for the horizontal trend display.

* This operation is not possible when the scale is displayed.

Press the **left (down) arrow key**.

The current trend is displayed in the top half (right half), and the historical trend is displayed in the bottom half (left half) of the screen.

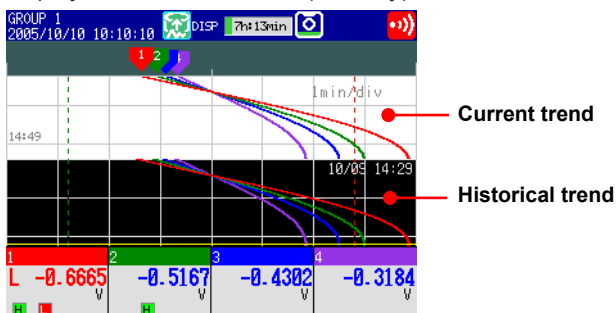

To revert to the original screen, press the **right (up) arrow key**.

- **Writing Add Messages**

For the operating procedure, see section 5.4.

4.3 Displaying Past Measured Data (Historical Trend Display)

- **Displaying Measured Data from the Specified Date and Time (Release number 3 or later)**

You can search for measured data from the specified date and time and display the results. You can search the display data or event data in the DX internal memory.

1. Press **DISP/ENTER** to show the display selection menu.
2. Select **DATA SEARCH** using the **arrow keys**, and then press **DISP/ENTER**.
A calendar appears for the month of the data at the cursor position.

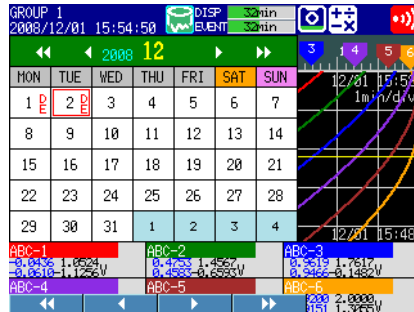

3. Use the **arrow keys** and the **soft keys** to change the date, and then press **DISP/ENTER**.

If there is display data and event data at that date, a data type selection window appears.

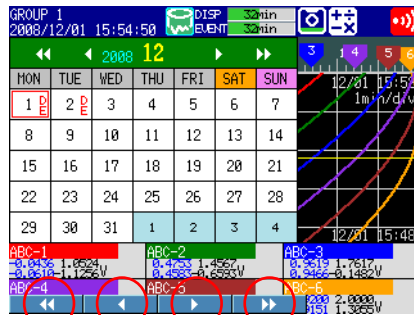

MON	TUE	WE
1 D E	2 D E	3
4	5	6
7	8	9
10	11	12
13	14	15
16	17	18
19	20	21
22	23	24
25	26	27
28	29	30
31		

Red square: Indicates the selected day
Use the **up, down, left, and right arrow keys** to move the red square and select a day.

D: Indicates that there is display data
E: Indicates that there is event data

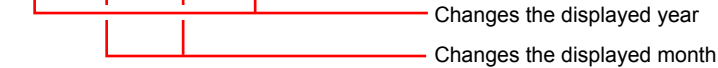

Searchable Range

You can search for data between the year 2000 and the year 2079.

Appearance of “D” and “E”

“D” appears when there is display data for the specified day and the DX is configured to record display data (see section 6.1 for details).

“E” appears when there is event data for the specified day and the DX is configured to record event data (see section 6.1 for details).

4. Select **Display** or **Event**, and press **DISP/ENTER**.

A search time input window appears.

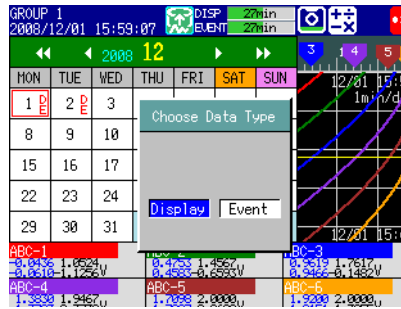

5. Enter the time you want to search for, and press **DISP/ENTER**.

If there is data for the time that you specify, the data appears in the historical trend display.

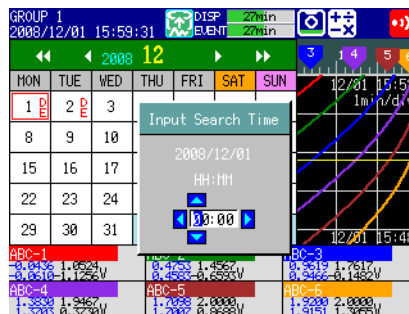

Display Example

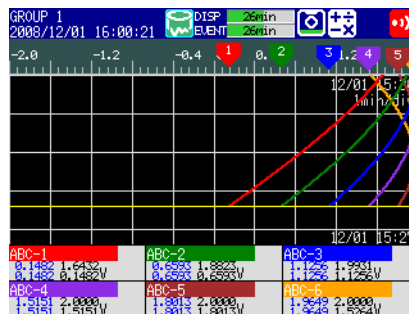

Display Conditions

- The cursor is located at the time that you specify for the search.
- All other display conditions are the same as those of the display before the search.
- If there is no data at the date and time that you specify, data from a later time in the same day is displayed. If there is no such data, an error message appears.
- If the display group that was being displayed before the search does not exist in the data that you have specified, the display group in the data with the lowest number is displayed.

4.3 Displaying Past Measured Data (Historical Trend Display)

- You can configure the calendar so that weeks start with Sunday or Monday.

Procedure

Press **MENU** (to switch to setting mode), hold down **FUNC** for 3 s (to switch to basic setting mode), and select the **Menu** tab > **Time Settings** > **Calendar display** > **1st weekday**.

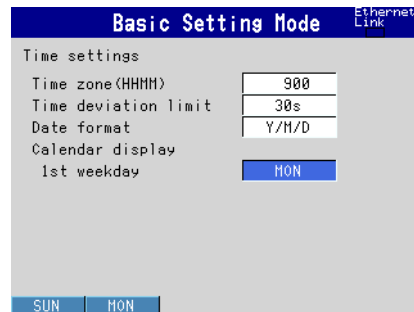

You can set the first weekday (the day that appears on the far left side of the calendar) to SUN (Sunday) or MON (Monday).

- Signature (Only on DXs with the /AS1 advanced security option)**
See the *Advanced Security Function (/AS1) User's Manual, IM 04L41B01-05EN*.

Explanation

• **ALL CHANNEL/GROUP CHANNEL**

In the group display, the waveforms of the channels that are registered to the group are displayed. In the all channel display, the waveforms of all channels that have been set to be recorded are displayed on the current group display. The waveforms of channels that are not registered to the group are displayed, without any additional information, in the waveform display area.

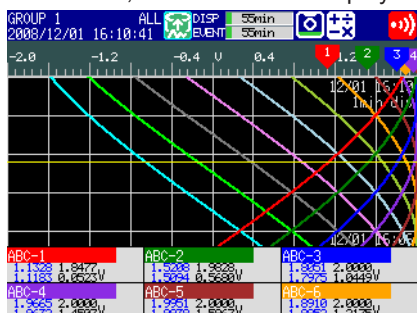

The waveforms of all channels are displayed.

• **AUTO ZONE**

Displays trend waveforms separately by assigning display areas (zones) to the set channels.

With AUTO ZONE OFF

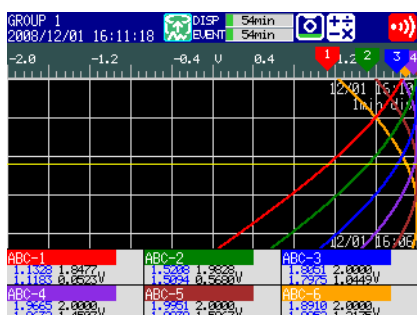

With AUTO ZONE ON

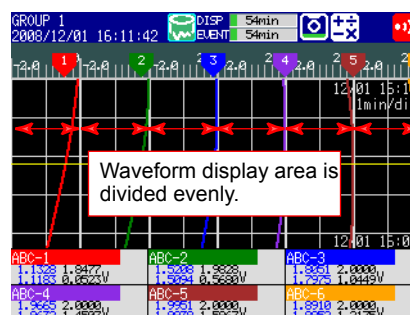

• **SCALE ON/OFF**

Select whether to display the scale. The current value mark of the scale indicates the value at the cursor position.

With SCALE ON

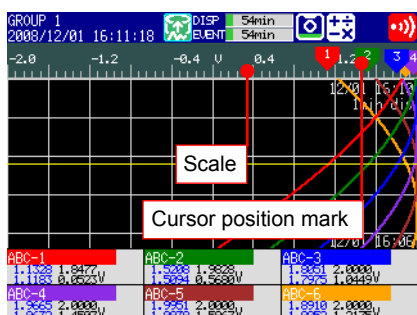

With SCALE OFF

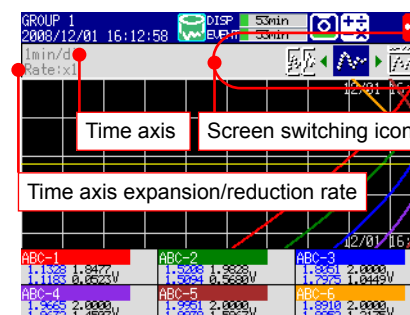

4.3 Displaying Past Measured Data (Historical Trend Display)

- FINE GRID**

With FINE GRID OFF

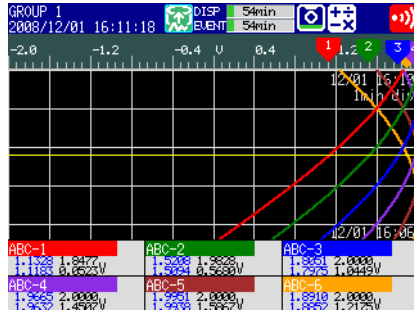

With FINE GRID ON

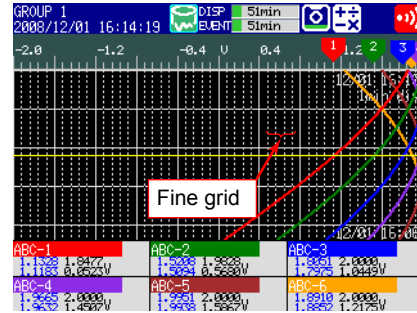

- TAG DETAIL**

When TAG DETAIL is set to ON and a tag does not fit into the typical tag display space, it covers the alarm and measured values so that it can be displayed completely. If the tag comment and number do not fit within a display area, they can be scrolled. The TAG DETAIL setting made in one display affects the settings in all of the other displays.

The figure below shows an example for when six channels are being displayed.

When the Tag Number Is Not Displayed

If TAG DETAIL is on, the tag comment is displayed as much as possible.

With TAG DETAIL OFF

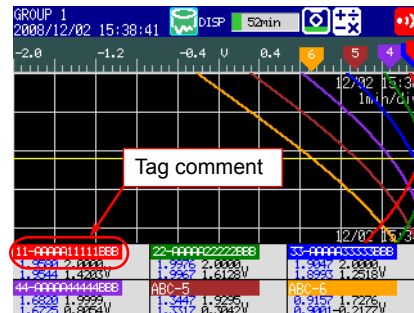

With TAG DETAIL ON

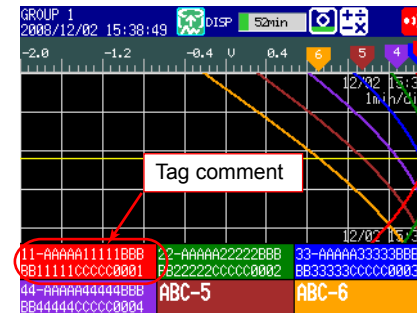

When the Tag Number Is Displayed

When TAG DETAIL is set to off, display priority is given to the tag number. If TAG DETAIL is on, the tag number and comment are displayed as much as possible.

With TAG DETAIL OFF

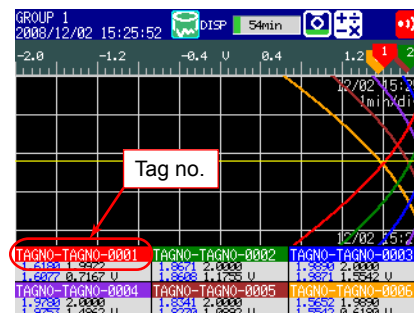

With TAG DETAIL ON

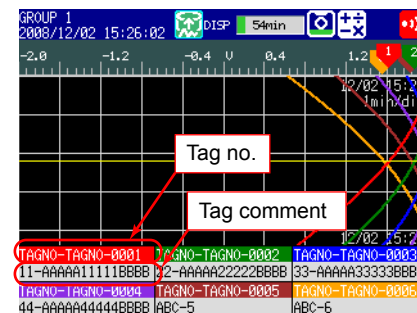

4.3 Displaying Past Measured Data (Historical Trend Display)

- **MESSAGE DISP 1, MESSAGE DISP 2**

Switch between message displays.

- **CURSOR VALUE/DIGITAL MAX/MIN**

Switch between numeric displays.

With DIGITAL MAX/MIN

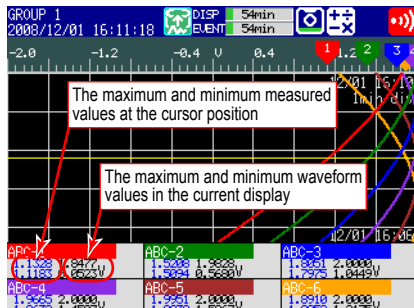

With CURSOR VALUE

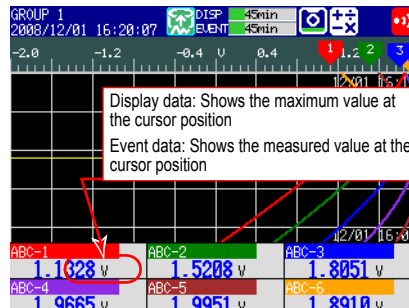

- **CURSOR TIME**

With CURSOR TIME ON

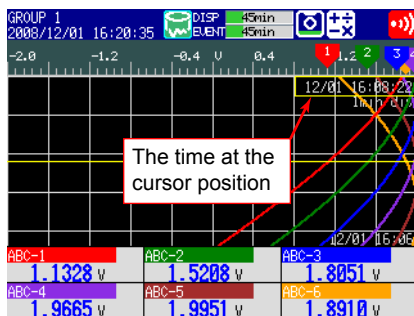

- **ABSOLUTE TIME/RELATIVE TIME**

With ABSOLUTE TIME

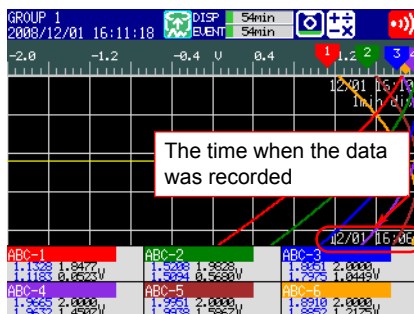

With RELATIVE TIME

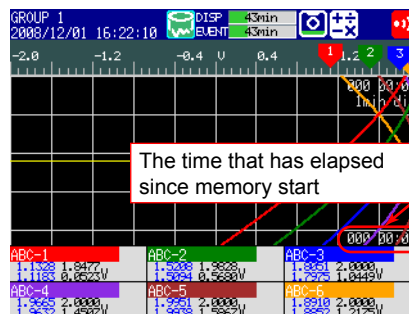

4.3 Displaying Past Measured Data (Historical Trend Display)

- **TOP CHANNEL (Release number 3 or later)**

The following example is for when the top channel is set to channel 3. The displayed scale marker and grid are those of the channel selected as the top channel.

If you switch from the trend history display to another display, the top channel setting is cleared. Channels other than the top channel are displayed in their assigned order within their group. (The order set by pressing **MENU** and then selecting the **MENU** tab > **Group set, Trip line**).

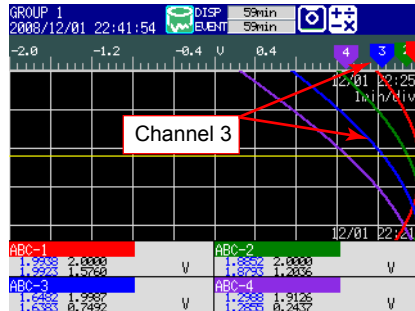

- **AUTO SPAN (Release number 3 or later)**

Before AUTO SPAN

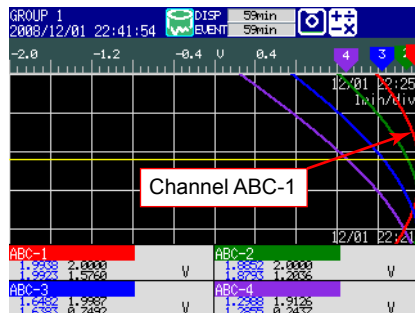

Using AUTO SPAN for channel ABC-1

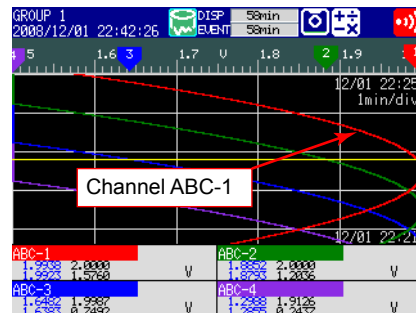

- **TIME AXIS > ZOOM+ and ZOOM-**

The time axis can be expanded or reduced around the cursor position.

- Display data: 2 times the trend display to 1/60 minimum
- Event data: Reduction only, up to 1/60 minimum

The minimum magnification and the factor by which the display can be expanded or reduced with one operation vary depending on the trend interval for the display data and on the sampling interval for the event data. To expand or reduce further, repeat the procedure.

With TIME AXIS ZOOM+

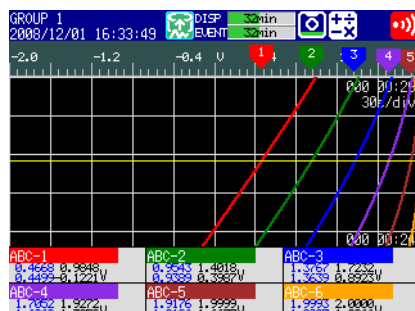

With TIME AXIS ZOOM-

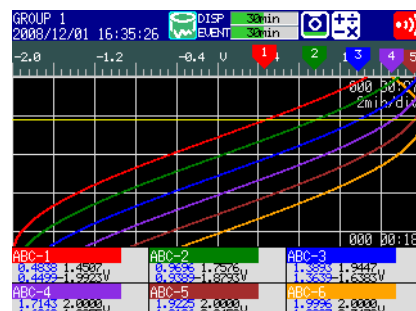

• **INFORMATION (Information on the Displayed Measured Data)**

The following information is displayed.

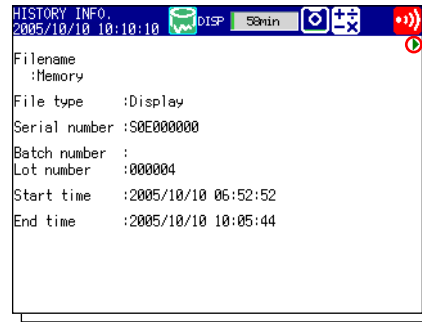

Page switch mark
Use the **left and right arrow keys** to switch the page.

Display	Description
File name	Data in the internal memory is displayed as "Memory." For a file on the external storage medium, the file name is displayed.
File type	Display corresponds to display data, and Event corresponds to event data.
Serial number	The serial number of the DX that was used.
Batch number, Lot number	Displayed when the file is created using the batch function.
Start time, End time	The start time and end time of recording.
User name	Name of the user who performed the operation. Displayed when the login function or /AS1 advanced security option was used.
Comment	A comment (when the batch function is in use).
Text field	A text field (when the batch function is in use).
Signature	Signature data (when the /AS1 advanced security option is in use).

Note

When measured data on the external storage medium is displayed, the serial number corresponds to that of the DX that was used to save the data.

• **Background Color of the Historical Trend**

You can change the background color of the historical trend.

For the procedure to change the background color of the historical trend, see section 5.13.

4.4 Display the Statuses of All Channels on One Screen (Overview Display)

This section explains how to use the overview display.
For a description of the function, see section 1.3.

Procedure

• Showing the Display

1. Press **DISP/ENTER** to show the display selection menu.
2. Press the **arrow keys** to select **OVERVIEW**, and press **DISP/ENTER**.
The display appears.

• Changing the Displayed Contents

1. Press **DISP/ENTER** to show the display selection menu.
2. Press the **right arrow key** to display the sub menu.
3. Press the **up and down arrow keys** to select the sub menu item.

Overview display sub menu

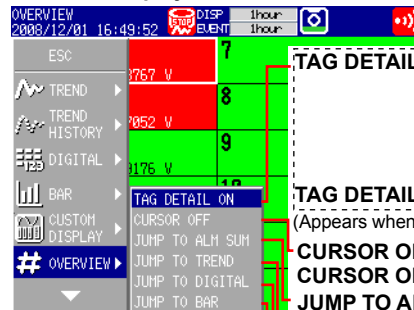

TAG DETAIL ON: When a tag does not fit into the typical tag display space, the alarm and measured values are covered so that the tag can be displayed completely.

TAG DETAIL OFF: Priority is not given to tag display.
(Appears when Tag Number is set to Use. See section 5.2 for details.)

CURSOR OFF: Clears the cursor

CURSOR ON: Displays the cursor

JUMP TO ALM SUM: Switches to the alarm summary

JUMP TO TREND: Switches to the trend display of the smallest group number that includes the channel selected with the cursor.

JUMP TO DIGITAL: Switches to the digital display of the smallest group number that includes the channel selected with the cursor.

JUMP TO BAR: Switches to the bar graph display of the smallest group number that includes the channel selected with the cursor.
(Not displayed with the default settings. To display, see section 5.17)

4. Press **DISP/ENTER** to change the displayed contents.
To close the menu without changing the displayed contents, press the **ESC** key.

• Showing the Trend, Digital, Bar Graph Display Containing the Specified Channel

1. Press the **arrow keys** to move the cursor, and select a channel.

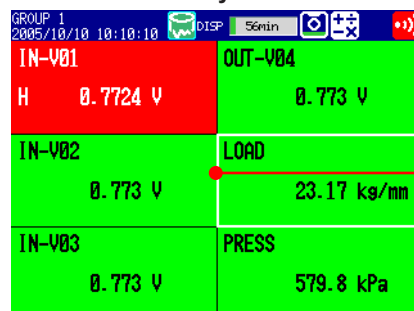

Cursor (white Frame)

2. Switch to the trend, digital, or bar graph display according to the procedure described in "Changing the Displayed Contents."

4.4 Display the Statuses of All Channels on One Screen (Overview Display)

- **Individual Alarm ACK Operation (Only on DXs with the /AS1 advanced security option)**

You can perform alarm ACK on individual alarms. This operation is referred to as “individual alarm ACK.” Individual alarm ACK can be performed when the settings are configured in the exact manner described below.

- Basic setting > Indicator is set to Hold.
For the setting procedure, see section 3.5.
- Relay > Relay Action on Ack is set to Reset.
For the setting procedure, see section 3.5 in the *DX2000 User's Manual*.
- Annunciator Mode is set to Off.
For the setting procedure, see section 3.12 in the *DX2000 User's Manual*.

1. Use the **arrow keys** to move the cursor to a channel with active alarms.
2. Press **DISP/ENTER** to show the display selection menu.
3. Press the **right arrow key** to display the submenu.
4. Use the **arrow keys** to select an alarm, and press **DISP/ENTER**.
The alarm output is released.

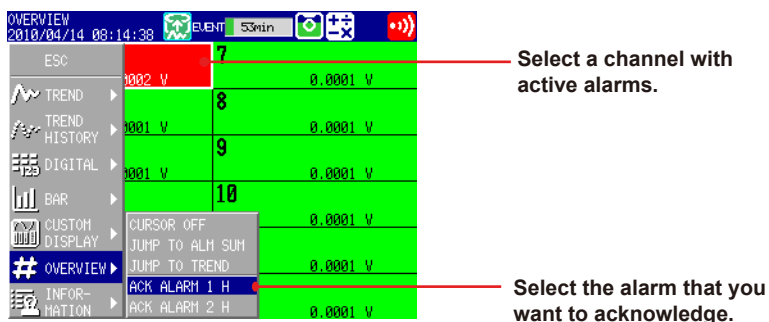

4.4 Display the Statuses of All Channels on One Screen (Overview Display)

- **TAG DETAIL**

The same as the TAG DETAIL setting in other displays.

The following example is for the DX1012 OVERVIEW display.

When the Tag Number Is Not Displayed (the TAG DETAIL does not appear)

Tag comments are displayed.

1-AAAAA1111BBBB BB11111CCCC0001 H 1.9990 V	7	0.0610 V
22-AAAAA2222BBBB BB22222CCCC0002 H 1.9467 V	8	
33-AAAAA3333BBBB BB33333CCCC0003 H 1.7617 V	9	-0.9465 V
44-AAAAA4444BBBB BB44444CCCC0004 H 1.4567 V	10	-1.3703 V
ABC-5 H 1.0524 V	11	-1.7007 V
ABC-6 H 0.5763 V	12	-1.9151 V

When the Tag Number Is Displayed

When TAG DETAIL is set to off, display priority is given to the tag number. If TAG DETAIL is on, the tag number and comment are displayed as much as possible.

With TAG DETAIL OFF

With TAG DETAIL ON

TAGNO-TAGNO-1111 H 1.9793 V	7	
TAGNO-TAGNO-2222 H 0.7894 V	8	
TAGNO-TAGNO-3333 H 1.2381 V	9	1.5706 V
TAGNO-TAGNO-4444 H 1.6025 V	10	1.1966 V
TAGNO-TAGNO-0005 H 1.0576 V	11	0.7411 V
TAGNO-TAGNO-0006 H 1.9861 V	12	0.2350 V

TAGNO-TAGNO-1111 H 1.9793 V	7	
TAGNO-TAGNO-2222 22-AAAAA2222BBBB BB22222CCCC0002 H 1.9467 V	8	
TAGNO-TAGNO-3333 33-AAAAA3333BBBB BB33333CCCC0003 H 1.7617 V	9	
TAGNO-TAGNO-4444 44-AAAAA4444BBBB BB44444CCCC0004 H 1.4567 V	10	
TAGNO-TAGNO-0005 ABC-5 H 1.0524 V	11	
TAGNO-TAGNO-0006 ABC-6 H 0.5763 V	12	

4.5 Displaying Various Information

This section explains how to display reports (/M1 and /PM1 options) and how to use the status display.

For a description of the function, see section 1.3.

Procedure

• Showing the Display

1. Press **DISP/ENTER** to show the display selection menu.
2. Press the **up and down arrow keys** to select **INFORMATION**.
3. Press the **right arrow key** to display the sub menu.
4. Press the **up and down arrow keys** to select the sub menu item.
To close the menu without changing the displayed contents, press the **ESC** key.

Information display submenu

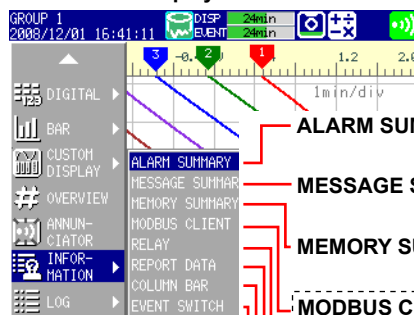

- ALARM SUMMARY:** Displays an alarm summary
See section 4.6.
- MESSAGE SUMMARY:** Displays a message summary
See section 4.7.
- MEMORY SUMMARY:** Displays a memory summary
See section 4.8.
- MODBUS CLIENT:** Displays the Modbus client status
- MODBUS MASTER:** Displays the Modbus master status
- RELAY:** Displays the relay status
(Not displayed with the default settings. To display, see section 5.17.)
- REPORT DATA:** Displays report data
- COLUMN BAR:** Displays report data using stacked bar graphs
- EVENT SWITCH:** Displays the status of the event level switches.

5. Press **DISP/ENTER**.
The display appears.

• Displaying the Report

• Switching the Displayed Report Data

The **Index** item on the report display shows “the number of the report data being displayed/the number of report data saved in the internal memory.” The largest report data number corresponds to the most recent report data.

Number of the report data being displayed

Number of report data saved to the internal memory

Ch	Unit	Sts	Ave	Max	Min	Sum
001	U	—	0.6496	0.9228	0.6923	1.572792E+02
002	U	—	0.6506	0.7066	0.5305	1.204333E+02
003	U	—	0.5377	0.5941	0.4383	9.954263E+01
004	U	—	0.4009	0.4355	0.3269	7.422102E+01

4.5 Displaying Various Information

Carry out the procedure below to switch the displayed report data.

- Up arrow key:** Report data being displayed + 1.
- Down arrow key:** Report data being displayed - 1.
- Left arrow key:** Report data being displayed + 10.
- Right arrow key:** Report data being displayed - 10.

Note

The display is not updated even if a new report is created while displaying the report data. Perform either of the operations below to display the most recent report data.

- Hold down the **left arrow key** until the latest report data is displayed.
- Press **DISP/ENTER** and display the report data again from the display selection menu.

Switching the Report Channels

Up to 12 report channels can be shown on one screen. If there are more than 12 report channels, you can switch the displayed report channels.

1. Press **DISP/ENTER** to show the display selection menu.
2. Press the **right arrow key** to display the sub menu.
3. Press the **up and down arrow keys** to select **CHANGE REPORT CH.**
4. Press **DISP/ENTER**.

The displayed report channels are switched.

Relay Status Display

Lists the statuses of the alarm output relays and internal switches. You cannot change the settings on this display.

Relay	Status	Relay	Status	Relay	Status
I01	Red	S01	Green	S16	Green
I02	Green	S02	Green	S17	Green
I03	Red	S03	Green	S18	Green
I04	Red	S04	Green	S19	Green
I05	Green	S05	Green	S20	Green
I06	Green	S06	Green	S21	Green
		S07	Green	S22	Green
		S08	Green	S23	Green
		S09	Green	S24	Green
		S10	Green	S25	Green
		S11	Green	S26	Green
		S12	Green	S27	Green
		S13	Green	S28	Green
		S14	Green	S29	Green
		S15	Green	S30	Green

Red: ON
Green: OFF

Modbus Status Display

Lists the statuses of the Modbus client or Modbus master commands.

For the operating procedure, see the *Communication Interface User's Manual, IM04L41B01-17E*.

No.	Status	Comm. Data	Server name	Registers
1	R ● Good	C01 - C08	modbus.dawstati	30001
2	W ○ None	1 - 4	192.168.1.80	40001
3	W ○ None	101 - 105	192.168.1.80	40010

Communication conditions: Read cycle : 1s, Connect.retry : 10min

Communication destination: Server name

DX channels: Comm. Data

Status: Status

Command: No.

- **Event Level Switch Status Display (Release number 3 or later)**

Displays the status of the event level switches. You cannot perform operations in this display.

Switch ID	Status	Switch ID	Status	Switch ID	Status
01	Red	11	Green	21	Green
02	Red	12	Green	22	Green
03	Red	13	Green	23	Green
04	Green	14	Green	24	Green
05	Green	15	Green	25	Green
06	Green	16	Green	26	Green
07	Green	17	Green	27	Green
08	Green	18	Green	28	Green
09	Green	19	Green	29	Green
10	Green	20	Green	30	Green

Red: On

Green: Off

4.6 Using the Alarm Summary

This section explains how to use the alarm summary.
For a description of the function, see section 1.3.

Procedure

- **Changing the Displayed Contents**

1. Press **DISP/ENTER** to show the display selection menu.
2. Press the **right arrow key** to display the sub menu.
3. Press the **up and down arrow keys** to select the sub menu item.

The screenshot shows the 'ALARM SUMMARY' menu with the following options: TAG DETAIL ON, ALARM SUMMARY, MESSAGE SUMMARY, MEMORY SUMMARY, MODBUS CLIENT, RELAY, REPORT DATA, COLUMN BAR, and EVENT SWITCH. A sub-menu is open showing: TO HISTORY (DISP), TO HISTORY (EV), TO OVERVIEW, CHANGE SORT KEY, and ASCENDING ORDER. Annotations explain the functions of these options:

- Sort symbol ▲ Ascending sort** and **▼ Descending sort**: Indicated by a red circle on the 'Alarm Time' header.
- TAG DETAIL ON:** When a tag does not fit into the typical tag display space, the alarm and measured values are covered so that the tag can be displayed completely.
- TAG DETAIL OFF:** Priority is not given to tag display.
- Display name:** Switches to the specified display.
- TO HISTORY (DISP):** Switches to the display data historical trend display.
- TO HISTORY (EV):** Switches to the event data historical trend display.
- TO OVERVIEW:** Switches to the overview display.
- CHANGE SORT KEY:** Sorts alarm information by channel or alarm time.
- ASCENDING ORDER:** Sorts in ascending order.
- DESCENDING ORDER:** Sorts in descending order.

4. Press **DISP/ENTER** to change the displayed contents.
To close the menu without changing the displayed contents, press the **ESC** key.

- **Moving the Cursor (➡) and Scrolling the Alarms**

The diagram shows the 'DISP/ENTER' key with four arrows pointing to its directions:

- Up arrow:** Scrolls the alarm information up by half a page. Moves the cursor up.
- Down arrow:** Moves the cursor down.
- Left arrow:** Moves the cursor left.
- Right arrow:** Scrolls the alarm information down by half a page.

- **Recalling the Historical Trend Display at the Point When the Alarm Occurred**

1. Select an alarm with the cursor.
2. Display the historical trend according to the procedure described in "Changing the Displayed Contents."

Explanation

- **CHANGE SORT KEY, ASCENDING ORDER, and DESCENDING ORDER**

The alarms are sorted in ascending or descending order by the following keys. The sort symbol is displayed next the sort item (see the figure above).

- **Channel number:** Sorts the alarms by channel number even if tags are being used. Alarms in a channel are sorted by the alarm level number.
- **Time of alarm occurrence/release**

• TAG DETAIL

The same as the TAG DETAIL setting in other displays.

When the Tag Number Is Not Displayed

When TAG DETAIL is on, tag comments are displayed in their entirety.

With TAG DETAIL OFF

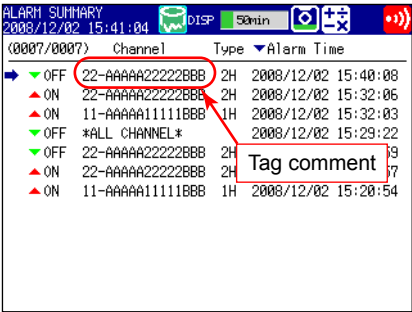

With TAG DETAIL ON



When the Tag Number Is Displayed

Tag numbers and comments are displayed.

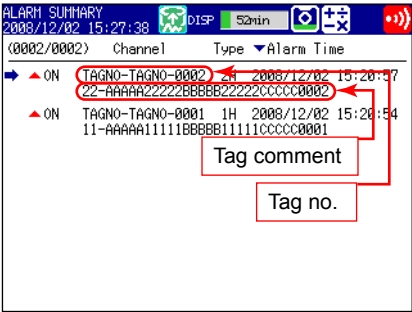

4.7 Using the Message Summary

This section explains how to use the message summary.
For a description of the function, see section 1.3.

Procedure

- **Changing the Displayed Contents**

1. Press **DISP/ENTER** to show the display selection menu.
2. Press the **right arrow key** to display the sub menu.
3. Press the **up and down arrow keys** to select the sub menu item.

The screenshot shows a terminal window with a menu. The menu items are: DIGITAL, BAR, CUSTOM DISPLAY, OVERVIEW, ANNUNCIATOR, INFORMATION, and LOG. The INFORMATION menu is expanded to show: ALARM SUMMARY, MESSAGE SUMMARY, MEMORY SUMMARY, MODBUS CLIENT, RELAY, REPORT DATA, COLUMN BAR, EVENT SWITCH, and TO HISTORY (DISP). The TO HISTORY (DISP) option is selected, and its sub-menu is shown: TO HISTORY (EV), DISP GROUP OFF, CHANGE SORT KEY, ASCENDING ORDER, and CHANGE DISP ITEM. A legend on the right explains the sort symbols and options.

Sort symbol
 ▲ Ascending sort
 ▼ Descending sort

Display name: Switches to the specified display
TO HISTORY (DISP): Switches to the display data historical trend display
TO HISTORY (EV): Switches to the event data historical trend display
DISP GROUP OFF: Displays the second of the tir when the messages were wri
DISP GROUP ON: Displays the groups to which the messages were written
CHANGE SORT KEY: Sorts messages by message number, time, group, or user name
ASCENDING ORDER: Sorts in ascending order
DESCENDING ORDER: Sorts in descending order
CHANGE DISP ITEM: Switches between displaying message times and groups and displaying the message user names

4. Press **DISP/ENTER** to change the displayed contents.
To close the menu without changing the displayed contents, press the **ESC** key.

- **Moving the Cursor (➡) and Scrolling the Messages**

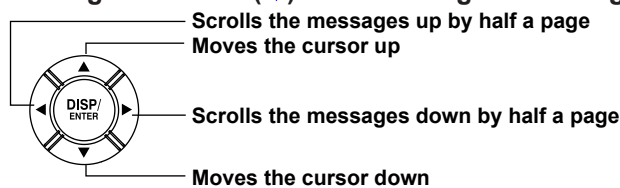

- **Recalling the Historical Trend Display at the Point When the Message Was Written**

1. Select a message with the cursor.
2. Display the historical trend according to the procedure described in "Changing the Displayed Contents."

Explanation

- **CHANGE DISP ITEM**
Switches between the following two message display methods.
 - Message, time, and group, or the second of the date and time when the message was written
 - Message, user name
- **CHANGE SORT KEY, ASCENDING ORDER, and DESCENDING ORDER**
The messages are sorted in ascending or descending order by the respective key. The sort symbol is displayed next the sort item (see the figure above).
- **DISP GROUP OFF/ON**
You can select what is displayed on the right of the screen: the groups that the messages were written to or the second of the time when the messages were written.

4.8 Using the Memory Summary

This section explains how to use the memory summary.
For a description of the function, see section 1.3.

Procedure

- **Changing the Displayed Contents**

1. Press **DISP/ENTER** to show the display selection menu.
2. Press the **right arrow key** to display the sub menu.
3. Press the **up and down arrow keys** to select the sub menu item.

The displayed data type is indicated with a green mark.

Display name:	Switches to the specified display
TO HISTORY:	Switches to the historical trend display
DATA SAVE MODE:	Switches to data save mode
SELECT SAVE:	Saves the selected file
M.SAMPLE SAVE:	Saves all manually sampled data.
REPORT SAVE:	Saves all report data
(Not displayed with the default settings. To display, see section 5.17.)	
ALL SAVE:	Saves all data
CHANGE DATA KIND:	Switches between display data and event data
FILENAME DISPLAY:	Displays the file name
TIME DISPLAY:	Displays the times of the first and last items of data in the file

4. Press **DISP/ENTER** to change the displayed contents.
To close the menu without changing the displayed contents, press the **ESC** key.

- **Moving the Cursor (➡) and Scrolling the Memory Information**

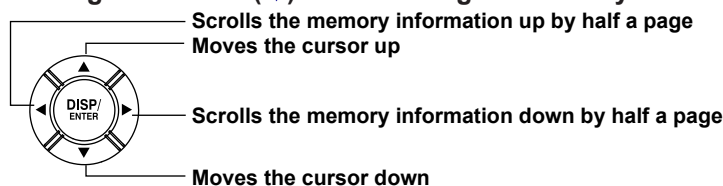

- **Displaying the Historical Trend for the Data Specified by Memory Summary**

1. Select the data with the cursor.
2. Display the historical trend according to the procedure described in “Changing the Displayed Contents.”

- **Saving the Data**

Save the data in the internal memory to the CF card or the USB flash memory (/USB1 option).

For a description of the function, see section 1.4.

1. Press **DISP/ENTER** to show the display selection menu.
2. Press the **right arrow** key to display the submenu.
3. Select **DATA SAVE MODE** with the **up and down arrow keys**.
4. Press **DISP/ENTER**.

The display switches to DATA SAVE MODE.

5. To save a specified file, select it with the cursor. This operation is not necessary in other cases.

Start Time	End Time	Data	Factor
12/02 15:12:24	12/02 15:13:16	27	Sample
12/02 15:12:14	12/02 15:12:16	2	Stop
12/02 15:03:42	12/02 15:12:06	253	Stop
12/02 15:02:28	12/02 15:03:10	22	Power Off
12/02 15:01:48	12/02 15:01:54	4	Power Off

Cursor
(move with the arrow keys)

6. Press **DISP/ENTER** to show the display selection menu.

End Time	Data	Factor
12/02 15:13:22	30	Sample
12/02 15:12:16	2	Stop
12/02 15:12:06	253	Stop
12/02 15:03:10	22	Power Off
12/02 15:01:54	4	Power Off

7. Use the **up and down arrow keys** to select **SELECT SAVE**, **ALL SAVE**, **M. SAMPLE SAVE**, or **REPORT SAVE**.

8. Press **DISP/ENTER**.

* If you are using a CF card and a USB flash memory (/USB1 option), the message "Which media do you want save to?" appears. Select the destination medium using the **arrow keys**, and press **DISP/ENTER**.

The measured data is saved.

Note

To abort the data saving operation in progress, carry out the procedure below.

Press **FUNC** and press the **Save Stop** soft key.

4.8 Using the Memory Summary

Progress Display When Saving All Data of the Internal Memory (Release Number 2 or Later)

If you carry out All Save* on the memory summary screen, a pop-up window appears showing the progress of the save operation.

* Function for saving all data in the internal memory to a CF card or USB flash memory.

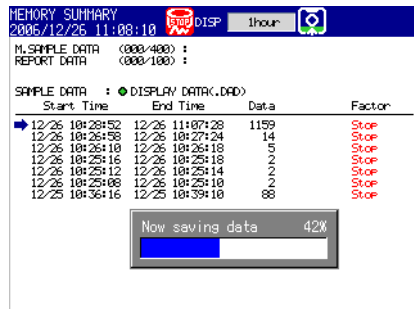

Note

- The pop-up window appears only when the memory summary display is showing.
- If you press the ESC key, the pop-up window clears temporarily and reappears approximately 10 seconds later.
- The time estimate for saving all data is indicated in the table below (when the memory is full of data). It may take longer depending on the operating conditions of the DX.

Save Destination	Time to Save All Data (Estimate)	
	CF Card	USB Flash Memory
Standard memory (internal memory size suffix code -3)	20 minutes	40 minutes

- To abort the data saving operation in progress, carry out the procedure below.
Press **FUNC** and press the **Save Stop** soft key.

• Displaying File Information (Only on DXs with the /AS1 advanced security option)

See the *Advanced Security Function (/AS1) User's Manual, IM 04L41B01-05EN*.

Explanation

• Save directory

- The data is saved by creating a directory each time the save operation is carried out.
Directory name: Specified string_Y YMMDD_HHMMSS (where YY to SS is the date of operation)

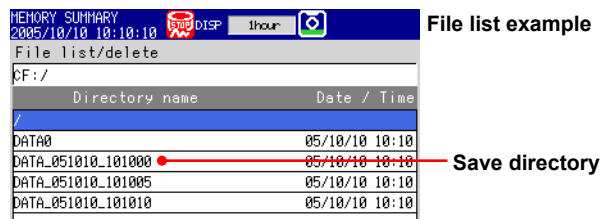

- Display data or event data that is in the process of adding data cannot be saved.
- The save operation explained here merely copies the data in the internal memory. It does not save the unsaved data in the internal memory (see section 1.4).
- Data saving is aborted when there is insufficient free space on the storage medium. Use a storage medium with sufficient free space when saving data.

4.9 Displaying a List of Operation Logs

Displays the following operation logs.

Login log^{*1}, error log, communication log, FTP log, Web log, e-mail log, SNTP log, DHCP log, Modbus status log, operation log^{*2}, and change settings log^{*2}

*1 Only on DXs without the /AS1 advanced security option

*2 Only on DXs with the /AS1 advanced security option

Procedure

• Displaying the Log

1. Press **DISP/ENTER** to show the display selection menu.
2. Press the **up and down arrow keys** to select **LOG**.
* To show **LOG** on the menu, see section 5.17.
3. Press the **right arrow key** to display the sub menu.
4. Press the **up and down arrow keys** to select the sub menu item.
To close the menu without changing the displayed contents, press the **ESC** key.
Sub menu items are **LOGIN**, **ERROR**, **COMMUNICATION**, **FTP**, **MAIL**, **WEB**, **SNTP**, **DHCP**, and **MODBUS**.
5. Press **DISP/ENTER**.
The display appears.

Explanation

• Login Log

This log is only for DXs without the /AS1 advanced security option. DXs with the /AS1 advanced security option use the operation log.

The log number of the last line and the total number of logs

User name

Operation method (see the table below)

Operation (see the table below)

Date/time

Action	Description
Login	Login
Logout	Logout
NewTime	Time change while memory is stopped
TimeChg	Time change through key operation
PowerOff	Power OFF (power failure occurred)
PowerOn	Power ON (recovered from a power failure)
TrevStart	Start the operation of gradually adjusting the time
TRevEnd	End the operation of gradually adjusting the time
TimeDST	Switch the daylight savings time
SNTPtimset	Time change by SNTP
TimeDST	Switch to or out of daylight saving time
CCSetEnd	Completion of calibration correction
CCExpire	Passing of the calibration due date without calibration having been completed

4.9 Displaying a List of Operation Logs

Factor	Description
KEY	Key operation
COM	Operations via communication
REM	Operation through the remote control function
ACT	Operation through event action
SYS	Operation by the system

• Error Log



(012/013) Time	No.	Message
2005/10/09 15:11:07	232	There is no available da..
2005/10/09 15:10:59	120	Measured value is incorr..
2005/10/09 15:07:15	151	This action is not possi..
2005/10/09 15:05:33	210	Media has not been inser..
2005/10/09 15:04:03	294	No time correction becau..

Error message*

Error code*

Date/time

* See section 10.1, "A List of Messages."

• Communication Log

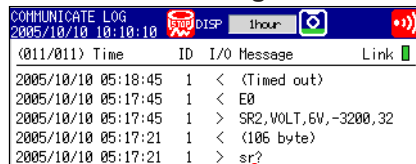

(011/011) Time	ID	I/O	Message	Link
2005/10/10 05:18:45	1	<	(Timed out)	
2005/10/10 05:17:45	1	<	E0	
2005/10/10 05:17:45	1	>	SR2,VOLT,6V,-3200,32	
2005/10/10 05:17:21	1	<	(106 byte)	
2005/10/10 05:17:21	1	>	sr?	

Message*

Input/output symbol (>: input, <: output)

User ID number (0: serial, 1 to 3: Ethernet)

Date/time

* See the *Communication Interface User's Manual, IM04L41B01-17E*.

• FTP Log

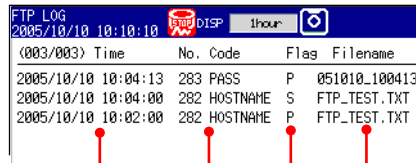

(003/003) Time	No.	Code	Flag	Filename
2005/10/10 10:04:13	283	PASS	P	051010_100413
2005/10/10 10:04:00	282	HOSTNAME	S	FTP_TEST.TXT
2005/10/10 10:02:00	282	HOSTNAME	P	FTP_TEST.TXT

File Name

FTP connection destination
(P: primary, S: secondary)

Error message (detail code)*

Date/time

* See section 10.1, "A List of Messages."

• Web Log

Time	Request	No.	Parameter
10/10 10:10:10	Message		STOP
10/10 10:10:00	Message		BATTERY
10/10 10:08:50	Screen		TREND GROUP=1
10/10 10:07:40	Screen		HISTORY GROUP=1
10/10 10:07:30	Message		HIGH VOLTAGE
10/10 00:37:50	Message	155	HIGH VOLTAGE

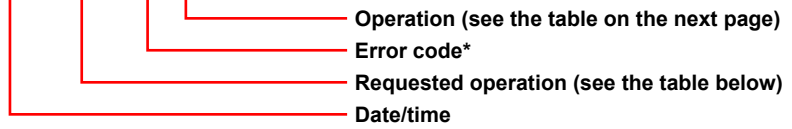

* See section 10.1, "A List of Messages."

Request	Description
Screen	Screen switch
Key	Key operation
Message	Message assignment/write
Batch Screen	Multi batch function (/BT2 option) screen change

Parameter	Description
TREND	Trend display
DIGIT	Digital display
BAR	Bar graph display
HIST	Historical trend display
OV	Overview display
DISP	DISP/ENTER key
UP	Up arrow key
DOWN	Down arrow key
LEFT	Left arrow key
RIGHT	Right arrow key
FAVOR	Favorite key
Messages	Character strings that have been written
Data Ref	Searches for data from a specific date and time and displays the data in the historical trend display.

• E-mail Log

Time	Type	No.	Recipient / Error
10/09 16:40:00	Time	2	user2
10/09 16:38:59	Alarm	1	user1
10/09 16:36:20	Test	2	user2
10/09 15:31:40	Test	1	user1
10/09 15:30:40	Test	261	SMTPサーバが見つか...

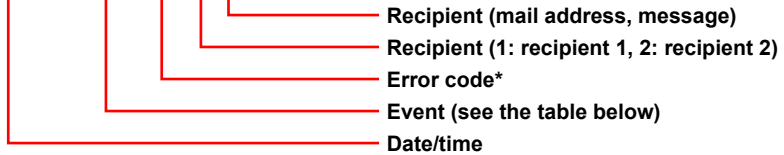

* See section 10.1, "A List of Messages."

Type	Description
Alarm	Alarm mail
Time	Scheduled mail
Report	Report timeout mail
Fail	Power failure recovery mail
Full	Memory full mail
Test	Test mail
Error	Error message mail
User locked	Invalid user mail (only on DXs with the /AS1 advanced security option)

4.9 Displaying a List of Operation Logs

• SNTP Log

(004/004) Time	No.	Code
2005/10/10 10:10:10		SUCCESS
2005/10/10 09:10:10		SUCCESS
2005/10/10 08:10:10	294	OVER
2005/10/10 07:10:20	291	TIMEOUT

Error message (detail code)*
 Error code*
 Date/time

* See section 10.1, "A List of Messages."

• DHCP Log

(004/004) Time	No.	Code
2005/10/10 08:15:24	297	NONAHE
2005/10/10 08:15:24	565	IPCONFIG
2005/10/10 08:08:24	564	RENEWED
2005/10/10 08:08:18	565	IPCONFIG

Error message (detail code)*
 Error code*
 Date/time

* See section 10.1, "A List of Messages."

• Modbus Status Log

(012/200) Time	Kind	Factor	Command
2005/10/10 06:36:36	M	NONE	03 W
2005/10/10 06:36:36	M	Dropout	
2005/10/08 18:50:06	C	GOOD	02 R
2005/10/08 18:50:06	C	GOOD	01 R
2005/10/08 18:50:06	C		02 R

Command number, command type
 (R: read, W: write)
 Communication status*
 Communication type (C: client, M: master)
 Date/time

* See the *Communication Interface User's Manual, IM04L41B01-17E*.

4.10 Displaying Stacked Bar Graphs (/M1 and /PM1 options; release number 3 or later)

- Operation Log (Only on DXs with the /AS1 advanced security option)

Cursor (blue arrow)
Move the cursor with the **arrow keys**.

Operation type*
User name
Operation*
Date and time

To switch displays, in the display selection menu, select **LOG > CHANGE DISP ITEM**, and press **DISP/ENTER**.

Detailed display

Additional information display

When you move the cursor to an item that has additional information, the **Add.info.** soft key appears at the bottom of the screen. Press the **soft key** to display the additional information. The additional information is displayed using the command syntax. See the *Communication Manual, IM04L41B01-17E*.

Press **ESC** to close the additional information display.

* See the *Advanced Security Function (/AS1) User's Manual, IM 04L41B01-05EN*.

- Change Settings Log (Only on DXs with the /AS1 advanced security option)

Operation type (see the table below)
User name
Saved setup file name
Date and time

Operation type	Description
K	Key operations
C	Communication operations

4.10 Displaying Stacked Bar Graphs (/M1 and /PM1 options; release number 3 or later)

This section explains how to use stacked bar graphs.

Procedure

- **Changing the Displayed Contents**

1. Press **DISP/ENTER** to show the display selection menu.
2. Press the **right arrow** key to display the submenu.
3. Press the **up and down arrow** keys to select the sub menu item.

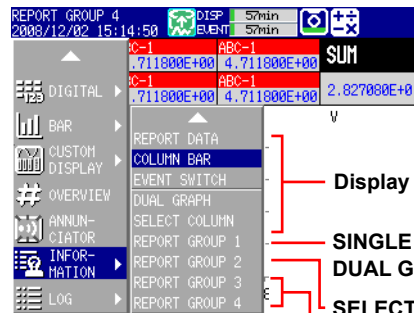

- Display name:** Switches to the specified display
- SINGLE GRAPH:** Displays a single graph
- DUAL GRAPH:** Displays two graphs
- SELECT GROUP:** Use the arrow keys to switch between displayed report groups.
- SELECT COLUMN:** Use the arrow keys to select a bar graph.
- REPORT GROUP 1 through 6*:** Select the report group that you want to display.

* Varies according to the model. For information about report groups, see section 9.5.

4. Press **DISP/ENTER** to change the display setting.

To close the menu without changing the display contents, press **ESC**.

- **Changing Groups, Selecting Bar Graphs, and Moving the Cursor**

The amount of data that the up and down arrow keys scroll through depends on the type of report data. For example, with an “H+D” report, you can use the arrows to scroll through the data one day at a time.

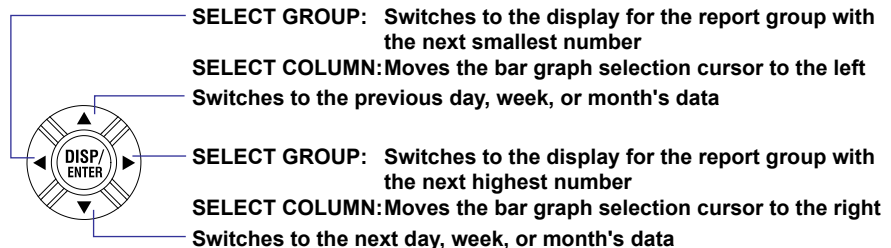

Explanation

• **SINGLE GRAPH/DUAL GRAPH**

You can display one or two bar graphs. The sums of the first channel in a group and of all other channels that have the same unit as it are displayed.

• **SINGLE GRAPH**

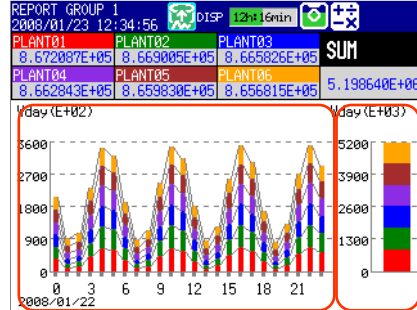

Numeric display section

Display area 1

Display area 2

The displayed report data varies depending on the report kind, which is set using the report function.

Report kind	Display Area 1	Display Area 2
Hour, H+D	Sums for each hour	Sums for the day
Day+Week	Sums for each day	Sums for the week
Day, D+M	Sums for each day	Sums for the month

• **DUAL GRAPH**

Shows the data from two consecutive periods at the top and bottom of the display.

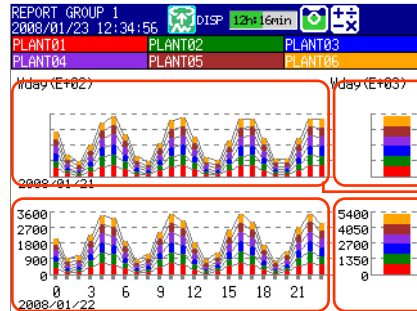

Channel number or tag
Numbers are abbreviated.

Display area 4

Display area 3

Display area 2

Display area 1

The displayed report data varies depending on the report kind, which is set using the report function. Display areas 1 and 2 contain the same report data listed above for SINGLE GRAPH display.

Report kind	Display Area 1	Display Area 2	Display Area 3	Display Area 4
Hour, H+D	Sums for each hour	Sums for the day	Sums for each hour	Sums for the day (The data of the day before the data in display areas 1 and 2)
Day+Week	Sums for each day	Sums for the week	Sums for each day	Sums for the week (The data of the week before the data in display areas 1 and 2)
Day, D+M	Sums for each day	Sums for the month	Sums for each day	Sums for the month (The data of the month before the data in display areas 1 and 2)

4.10 Displaying Stacked Bar Graphs (/M1 and /PM1 options; release number 3 or later)

Note

The numbers on the vertical axis of display areas 3 and 4 and the dates on the horizontal axis are abbreviated.

Display areas 3 and 4 can only display the data from the period immediately preceding that of display area 1 and 2.

- **Selecting a Bar**

When SINGLE GRAPH is selected, you can move the cursor to a bar that you want to check, and view the sums of each channel and the sums of all channels of the report group at the cursor position.

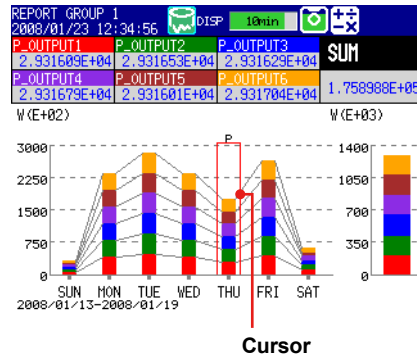

The sums of each channel and the sums of all channels of the report group at the cursor position

- **Power Failure and Time Adjustment Indications**

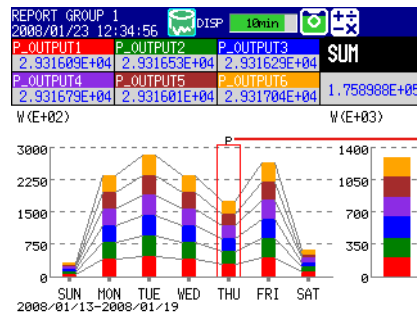

Indicates a power failure
A "C" appears if more than one report has been filed for the same time period.

- Power failure
A "P" indicates when a power failure occurred and a report was supposed to be filed. A "P" also indicates when the DX recovered from a power failure and the next report was filed.
 - Time adjustment
When a time adjustment causes a report to be filed twice because the time was moved back, the time adjustment is marked with a "C," and the bar graph of the report that was filed first is used.
- If the data for a period does not exist because of a power failure or time adjustment, a bar graph for the period will not be displayed.

5.1 Setting Display Groups

Assign channels and set the group name for each display group. Set lines at specified positions in the waveform display range on the Trend display.

Setup Screen

Press **MENU** (to switch to setting mode), and select the **Menu** tab > **Group set, Trip line**.

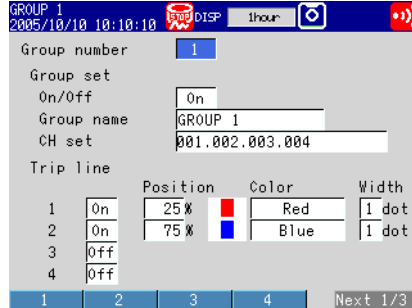

Setup Items

- **Group number**
Select the target group number (1 to 10).
- **Group**
 - **On/Off**
Turn **On** the groups you want to use.
 - **Group name**
Set the group name. (up to 16 characters, `A|a|#|1`)
 - **CH set**
Set up to six channels from measurement channels and computation channels (/M1 and /PM1 options).
 - Enter the channel number using two or three digits.
 - Separate each channel with a period.
 - To specify a range of consecutive channels numbers, use a hyphen.
Example: To assign channels 1 and 5 to 8, enter "001.005-008."

Note

- The trend, digital, and bar graph displays are shown in the specified order.
- A channel can be assigned to multiple groups.
- The same channel cannot be assigned multiple times in a group.

5.1 Setting Display Groups

Note

The channel settings of a display group can be copied to another group on a DX with release number 2 or later.

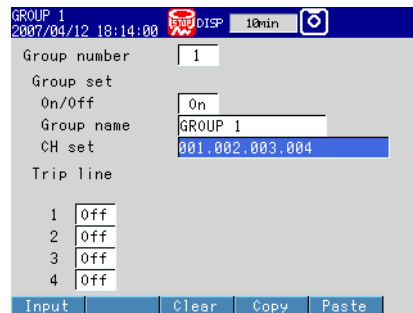

Procedure

1. Select the copy source channel settings.
 2. Press the **Copy** soft key.
 3. Select the copy destination channel settings.
 4. Press the **Paste** soft key. The channel settings are copied.
-

- **Trip line**

Set lines at specified positions in the waveform display range on the Trend display.

- **On/Off**

Turn **On** the trip lines you want to display.

- **Position**

Set the position in the range of 0 to 100% of the display width.

- **Color**

The default colors are red, green, blue, and yellow. If you want to change the color, select from the 24 available colors.

- **Width**

Set the line width of the trip line in dots (1 to 3).

5.2 Displaying Tags or Channel Numbers

Display the channels using tags or channel numbers. On DX release numbers 3 and later, tags have tag numbers and tag comments. The tag number is a fixed number that corresponds to the measurement source. The tag comment can be used to list details about the channel. You can choose whether or not to use tag numbers.

Setup Screen

- **Tag/Channel**

Press **MENU** (switch to the setting mode), hold down **FUNC** for 3 s (switch to the basic setting mode), and select **Environment > Operating Environment**.

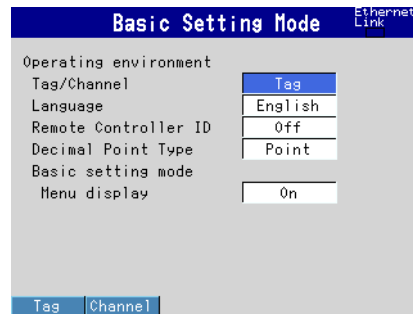

- **Tag Number Use/Not (Release number 3 or later)**

Press **MENU** (to switch to setting mode), hold down **FUNC** for 3 s (to switch to basic setting mode), and select the **Environment** tab > **Input, Alarm**.

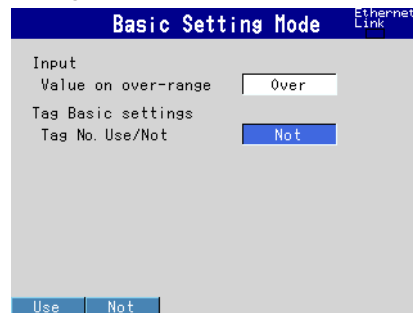

- **Tag**

Press **MENU** (to switch to setting mode), and select the **Menu** tab > **Meas channel > Tag, Memory, Delay**.

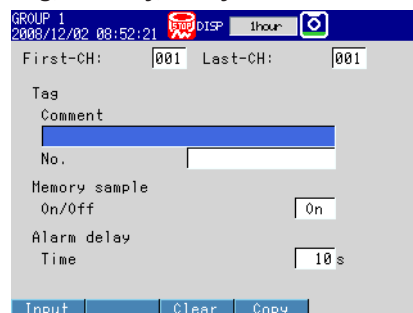

Setup Items

- **Operating environment > Tag/Channel**

This setting applies to all channels.

Setting	Description
Tag	Displays tag numbers and comments. <ul style="list-style-type: none"> • If an allotted display space is not large enough to display a tag number and a tag comment, priority is given to the tag number. • Depending on display space limitations, it may not be possible to display the entire tag. • If a channel is not configured to display tag numbers or comments, the channel number is displayed.
Channel	Displays channel numbers.

* Tag numbers are available for release numbers 3 and later.

- **Tag Basic settings > Tag No. Use/Not (Release number 3 or later)**

To display tag numbers, select “Use.” This setting applies to all channels.

- **First-CH, Last-CH**

Set the target channels. The target channels are common with the other items that are displayed on the screen.

- **Tag > Comment**

Set the tag comment. On a DX with a release number of 3 or later, you can enter up to 32 characters. On a DX with a release number of 2 or earlier, you can enter up to 16 characters. The characters that can be entered are: $\boxed{Aa\#1}$.

- **Tag > No. (Release number 3 or later)**

This setting only appears when you have enabled the use of tag numbers.

Sets the tag number. (Up to 16 characters: $\boxed{Aa\#1}$)

- **Items Displayed for Different Tag and Channel Settings**

Text is displayed depending on the tag and channel settings as shown in the figure below.

Operating Environment	Tag Basic Settings	Tag ^{*1}		Displayed Text		
		Tag No.	Tag Comment	Channel Number	Tag Number	Tag Comment
Tag	Use	Input	Input	No	Yes	Yes
			Not input	No	Yes	No
		Not input	Input	Yes ^{*2}	No	Yes
			Not input	Yes	No	No
	Not	—	Input	No	No	Yes
			Not input	Yes	No	No
Channel	Use	—	—	Yes	No	No
	Not	—	—	Yes	No	No

“Yes” means that the item is displayed

“No” means that the item is not displayed

*1 “Input” means that characters are input.

“Not input” means that no characters are input.

“—” means that the setting does not affect the display.

*2 Channel numbers are displayed instead of tag numbers.

5.3 Setting the Trend Interval and Switching to the Secondary Trend Interval

Set the trend interval. Switch the trend interval to the secondary trend interval while the memory sampling is in progress. Automatically write messages when the trend interval is switched.

For a description of the function, see section 1.3.

Setup Screen

- **Switching the Trend Interval and Writing Messages (When Using the Secondary Trend Interval)**

Press **MENU** (to switch to setting mode), hold down **FUNC** for 3 s (to switch to basic setting mode), and select the **Environment** tab > **View, Message**.

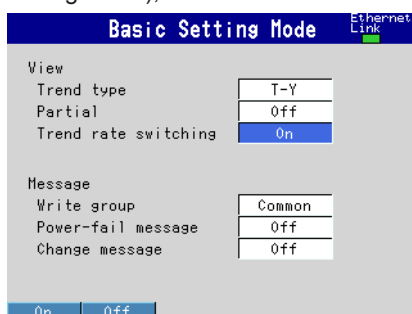

- **Trend interval [/div] and Secondary interval [/div]**

Press **MENU** (to switch to setting mode), and select the **Menu** tab > **Display** > **Trend/Save interval**.

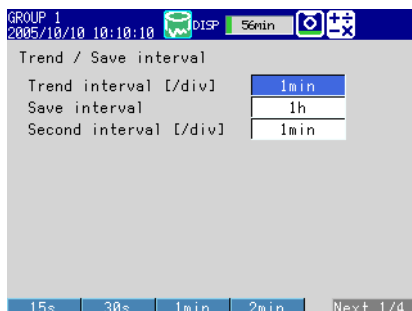

Setup Items

- **View > Trend rate switching**

On: Enables the function that switches the trend interval while the memory sampling is in progress. The “Second interval [/div]” item is displayed in the setting mode.

* When the trend rate switching function is **On**, the DX cannot be configured to record both the display and event data (see section 6.1).

- **Message > Change message**

On: Writes the time the interval is switched and the new trend interval as a message when the trend interval is switched.

On DXs with the /AS1 advanced security option, a message is written even when the setting mode setup items are changed during memory sampling.

Item	Message
Alarm setting change	AlarmSet
Alarm delay time change	AlmDlaySet
Calibration change	Calibration correction Setting

5.3 Setting the Trend Interval and Switching to the Secondary Trend Interval

- **Trend interval [div] and Second interval [div]**

Select the time corresponding to 1 division of the time axis on the trend display from below: You cannot specify a trend interval that is faster than the scan interval.

5s^{*1}, 10s^{*1}, 15s^{*2}, 30s, 1min, 2min, 5min, 10min, 15min, 20min, 30min, 1h, 2h, 4h, and 10h

*1 Selectable on the DX1002, DX1004, DX1002N, and DX1004N (release number 3 or later).

*2 Selectable on the DX1006, DX1012, DX1006N, and DX1012N when the scan interval is set to fast sampling mode (release number 3 or later).

Note

If the trend interval is set greater than or equal to 1h/div on a DX with release number 2 or later, the month, day, and hour at the grid position are displayed on the screen. The display format can be changed by setting the date format.

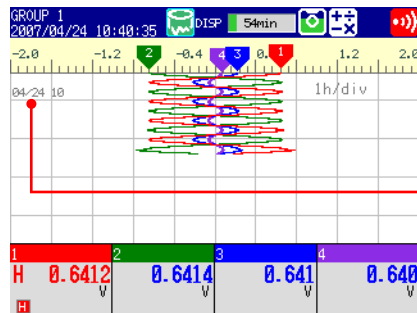

Month, day, and hour at the grid position.

Procedure

- **Switching the Trend Interval**

1. In the operation mode, press **FUNC**.

The FUNC key menu appears.

2. Press the **Normal speed** soft key or **Second speed** soft key.

The trend interval is switched. A message is written on the trend display (when the change message is turned ON).

Display example: 10:53 1min/div

- **Changing the Trend Display Time Axis While Recording (Memory sampling) Is in Progress (Release number 3 or later)**

On a DX whose release number is 3 or later, you can change the secondary trend interval even while recording (memory sampling) is in progress. If you are using the secondary trend interval to display waveforms and you change it, the time axis will change immediately afterwards.

Note

Only the displayed time axis changes when you switch to the secondary trend interval. The data sampling interval does not change.

5.4 Writing Messages

Write messages.

Setup Screen

- **Message Write Group**

Press **MENU** (to switch to setting mode), hold down **FUNC** for 3 s (to switch to basic setting mode), and select the **Environment** tab > **View, Message**.

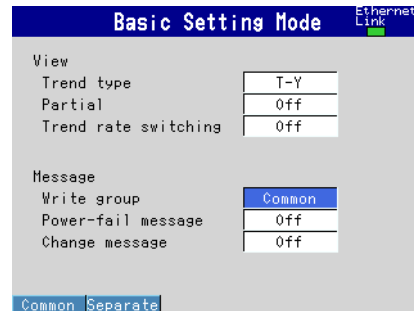

- **Setting the Messages**

Press **MENU** (to switch to setting mode), and select the **Menu** tab > **Message**.

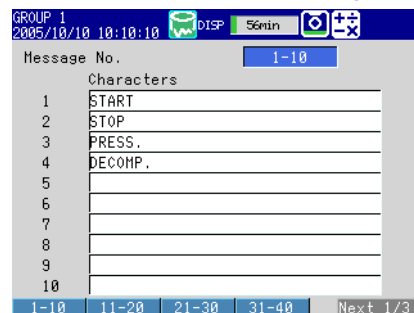

Setup Items

- **Message**

- **Write group**

This setting applies only for messages that are written using keys.

Settings	Description
Common	Write the message to all groups.
Separate	Write the message to the displayed group.

If you are using the multi batch function (/BT2 option), see the *DX1000/DX1000N/DX2000 Multi Batch (/BT2) User's Manual, IM04L41B01-03E*.

- **Power-fail message**

See section 5.16.

- **Change message**

See section 5.3.

5.4 Writing Messages

- **Message No.**

Select the message number (1 to 100). Messages 1 to 10 are common with free messages.* If a message is changed as a free message, the old message is overwritten.

* Messages that are written by creating the message on the spot.

- **Message > Characters**

Set the message. (up to 32 characters, $Aa\#1$)

Procedure

- **Writing Messages**

Messages cannot be written when the memory sampling is stopped.

1. Display the group to write the message.
 - If a screen unrelated to a group such as the overview is displayed, messages are written to all groups even when **Write group** is set to **Separate**.
 - Messages are written to all groups regardless of the displayed screen when **Write group** is set to **Common**.
2. Press **FUNC**.
The FUNC key menu appears.
3. Press the **Message** soft key.
4. Press the **soft key** corresponding to the desired message number range (example: [1-10]).

A list of message is displayed.

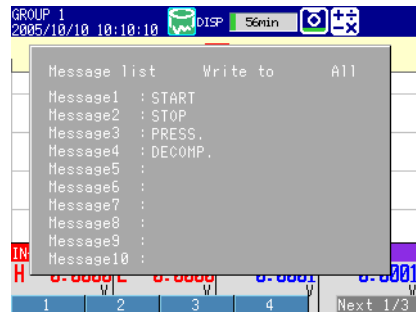

5. Press the **soft key** corresponding to the number of the message you want to write.

A message mark, time, and message are shown on the trend display.

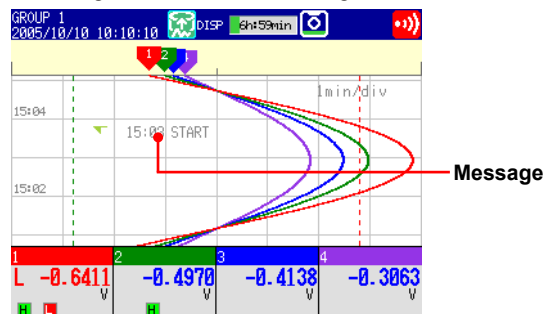

• **Writing Free Messages**

Create a message on the spot and write it.

1. Display the group to write the message.
2. Press **FUNC**.
The FUNC key menu appears.
3. Press the **Free message** soft key.
4. Press a message number **soft key**.
The message entry window appears.
5. Enter the message. (up to 32 characters, $[Aa\#_]$)
6. Select **ENT** and press **DISP/ENTER**.
A message mark, time, and message are shown on the trend display.

• **Writing Add Messages**

Add messages to the past data positions. This operation can be carried out on the past section of the data that is currently being memory sampled.

1. Carry out the procedure below to show the historical trend of the data that is currently being memory sampled.
Press **DISP/ENTER** and select **TREND HISTORY > (group name) > DISP/ENTER**
2. Press the **arrow keys** to move the cursor to the position you want to write the message.
3. Write the message according to the procedure given in "Writing Messages" or "Writing Free Messages." Use the **Add Message** or **Add Free Message** soft key.

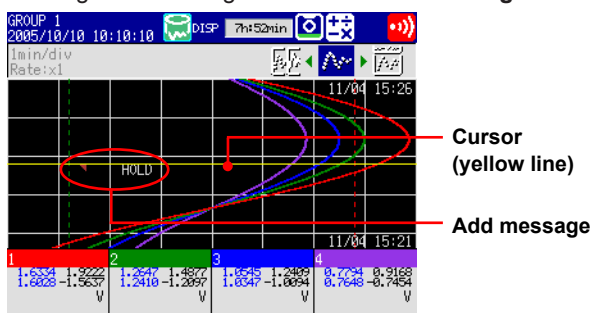

Explanation

• **Display Color of Messages**

The message colors on the trend display are shown below. You cannot change them.

No.	1	2	3	4	5	6	7	8	9	10
Color	Red	Green	Blue	Blue violet	Brown	Orange	Yellow-green	Light blue	Violet	Gray

The colors for messages 11 to 100 are repetitions of the colors above.

• **Add Message**

- The message timestamp is the time that the message is written. It is not the time stamp of the data at the position where the message is written.

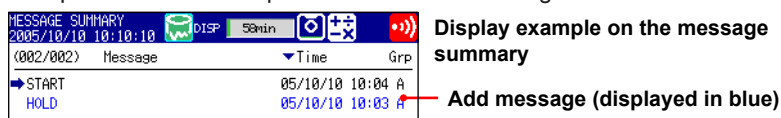

- Up to 50 messages can be written.
- Messages cannot be added to data in the internal memory that has already been saved to a file or data that has been loaded from the external storage medium.

5.5 Changing the Channel Display Colors

Change the channel display colors. The settings are applied to the trend and bar graph displays.

Setup Screen

Press **MENU** (to switch to setting mode), and select the **Menu** tab > **Meas channel** > **Color**.

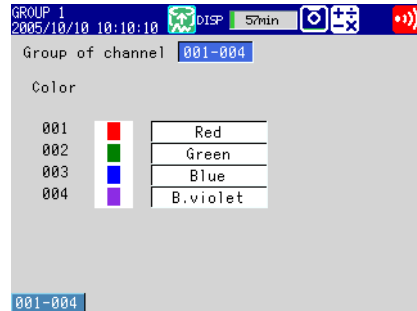

Setup Items

- **Group of channel**
Select the target channels.
- **Color**
To change the color, select from the following 24 colors.
Red, green, blue, blue violet, brown, orange, yellow-green, light blue, violet, gray, lime, cyan, dark blue, yellow, light gray, purple, black, pink, light brown, light green, dark gray, olive, dark cyan, and spring green

5.6 Displaying Channels in Display Zones

Specify a waveform display zone for each channel so that waveforms do not overlap. For a description of the function, see section 1.3.

Setup Screen

Press **MENU** (to switch to setting mode), and select the **Menu** tab > **Meas channel** > **Zone, Scale**

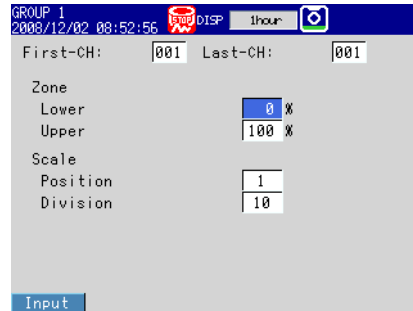

Setup Items

- **First-CH, Last-CH**
Select the target channels. The target channels are common with the other items that are displayed on the screen.
- **Zone > Lower, Zone > Upper**
Sets the zone in which the waveform is displayed. You can set **Lower** and **Upper** as a position (%) when taking the maximum display width to be 100%. Set **Upper** greater than **Lower**, and the zone width (**Upper – Lower**) greater than or equal to 5%.
Lower: 0 to 95%
Upper: 5 to 100%

5.7 Displaying a Scale on the Trend Display

Display a scale on the trend display.

For a description of the function, see section 1.3.

Setup Screen

- **Scale Position and Number of Scale Divisions**

Press **MENU** (to switch to setting mode), and select the **Menu** tab > **Meas channel** > **Zone, Scale**.

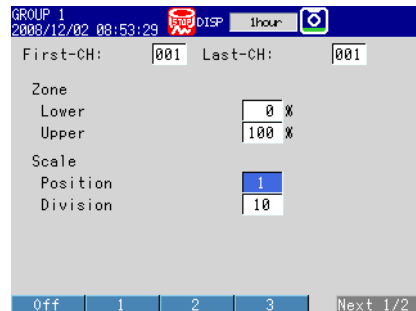

- **Number of Displayed Scale Digits and Current Value Indicator**

Press **MENU** (to switch to setting mode), and select the **Menu** tab > **Display** > **Trend**.



- **Showing the Scales**

To show scales on the trend display, press **DISP/ENTER** (show the display selection menu) > the **right arrow key** (show the sub menu), and select **SCALE ON** (see section 4.2).

Setup Items

- **First-CH, Last-CH**

Select the target channels. The target channels are common with the other items that are displayed on the screen.

- **Scale > Position**

Select the scale display position on the trend display from 1 to 6. Select **Off** if you do not wish to display the scale.

• **Scale > Division**

Set the number of divisions to make with the main scale marks on the trend display to a value from 4 to 12 or C10.

C10: The scale is equally divided into 10 sections by main scale marks, and scale values are indicated at 0, 30, 50, 70, and 100% positions on the trend display.

The figure below is an example in which each scale is displayed with the position shifted.

Vertical Trend Display

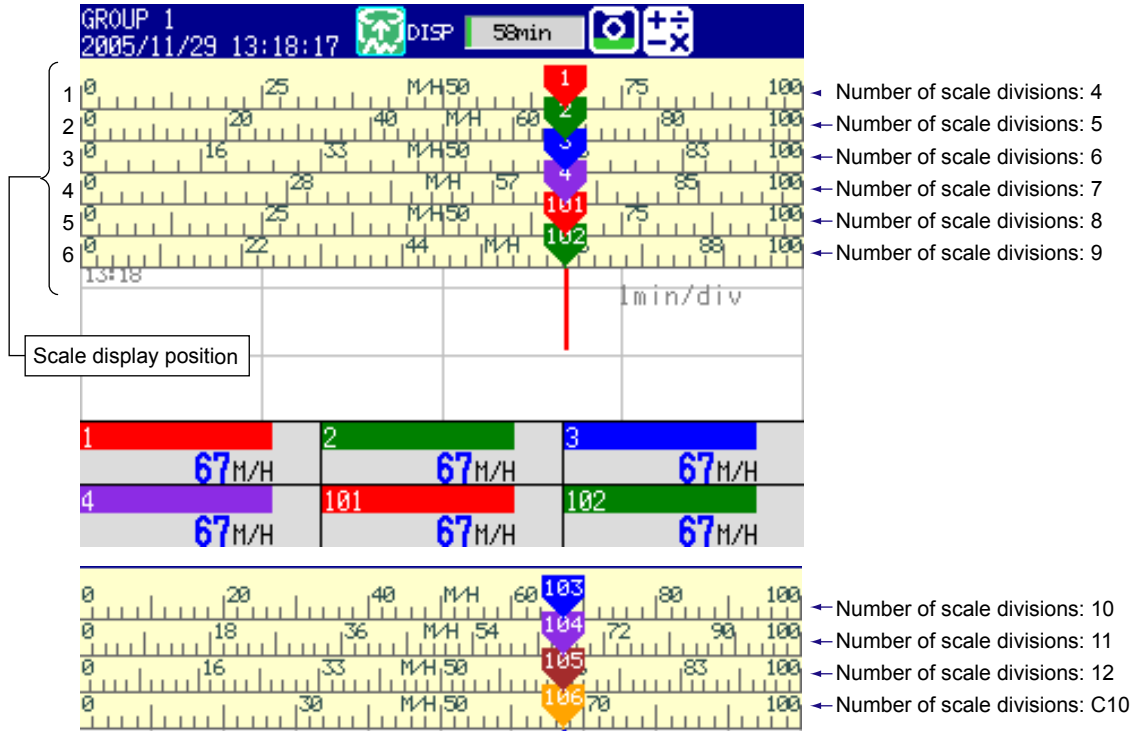

Horizontal Trend Display

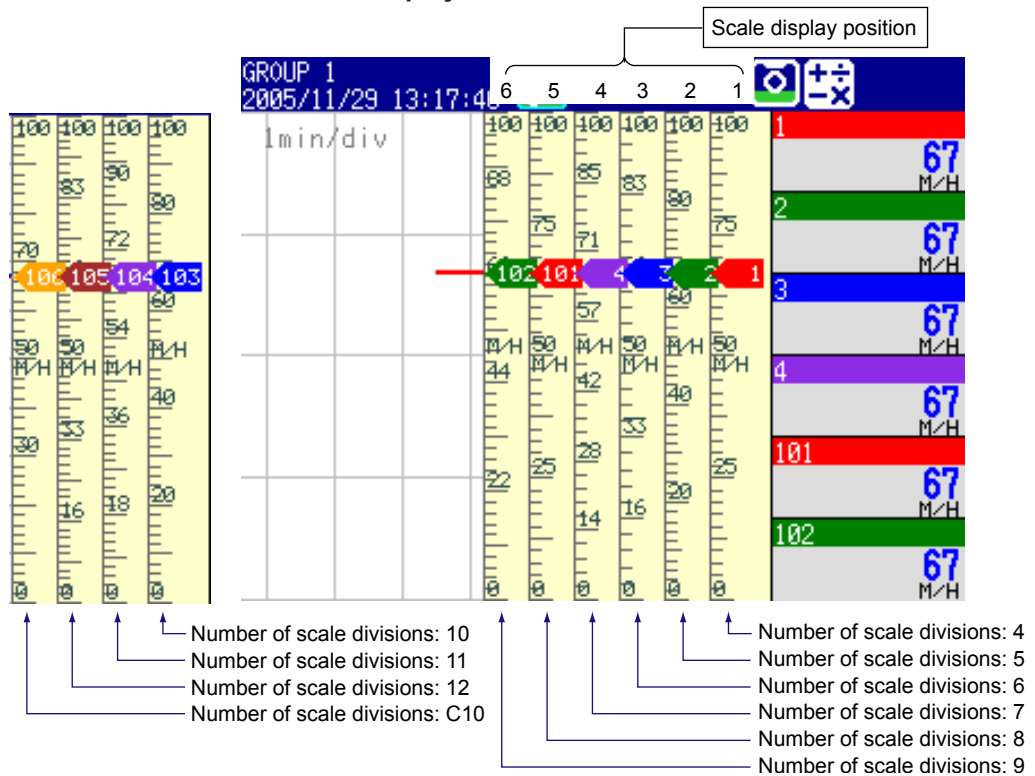

5.7 Displaying a Scale on the Trend Display

Note

- If the scales of multiple channels are set to the same position, the scale of the channel assigned first to the group is displayed.

Example: If the order of assignment of a group is **003.002.001**, and the scale display position of all channels is set to **1**, the scale of channel 3 is displayed at display position 1.
- Even if some of the scale display positions are skipped, the scale is packed towards display position 1.

Example: Suppose the assignment of channels to a group is **001.002.003**, and the display positions of the scales are set to 1, 3, and 6, respectively. The scales are actually displayed at positions 1, 2, and 3, respectively.
- The scale is divided into 4 to 12 sections by the main scale marks. The section between the main scale marks is divided into 5 or 10 subsections by medium and small scale marks. However, small scale marks are not displayed in the following cases.
 - When the resolution of the input range is smaller than the total number of small scale marks.
 - When zone display is used.
 - When partial expanded display is used (numbers are displayed at the ends of the scale and at the boundary position).
- The scale values are displayed according to the following rules.
 - If the number of scale divisions is 4 to 6 for the vertical trend display, values are displayed at all main scale marks. If the number of scale divisions is greater, the values are displayed at every other main scale marks.
 - Scale upper and lower limits are displayed at the ends of the scale.
 - Scale values are displayed up to 3 digits excluding the minus sign. However, if the integer part of values at the ends of the scale is both 1 digit or the integer part is zero, 2 digits are displayed.

Example: If the scale is -0.05 to 0.50 , the lower limit is -0.0 and the upper limit is 0.5 ."
 - If the integer part of either end of the scale is 2 or 3 digits, the fractional part is truncated.

Example: If the scale is 0.1 to 100.0 , the lower limit is 0 and the upper limit is 100 ."
 - If the integer part of either end of the scale is 4 or more digits, the value is displayed using a 3-digit mantissa and exponent like $\times 10$ or $\times 10^2$.

Example: If the scale is 10 to 2000 , the lower limit is 1 and the upper limit is 200×10 ."
- The unit is displayed near the center of the scale. If partial expanded display is used, the display position is offset from the center. For the vertical trend display, the number of characters that can be displayed is up to six. For the horizontal trend display, the number of characters that can be displayed is up to three. However, if the scale digit display is set to Fine, up to four characters are displayed.

Trend > Scale > Digit

Fine: For example, if the scale range is 49.0 to 50.0 and you select "Normal," the scale values are displayed using 2 digits (49 for example, see Note above). If you select "Fine," the scale values are displayed using 3 digits as shown below.

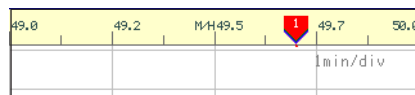

Trend > Scale > Value indicator

The current value is displayed as a mark or a bar graph.

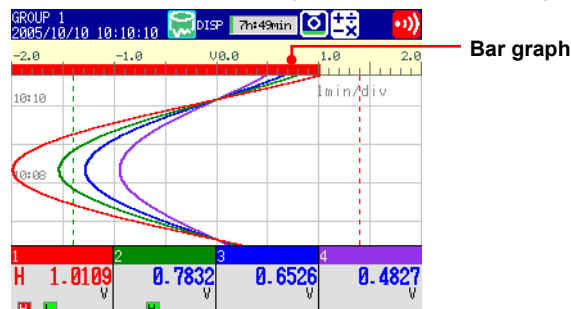

5.8 Displaying Alarm Point Marks and Color Scale Band on the Scale

Display alarm point marks on the scale. Display the specified range with a color band. For a description of the function, see section 1.3.

Setup Screen

Press **MENU** (to switch to setting mode), and select the **Menu** tab > **Meas channel** > **Alarm mark** or **Color scale band**.

• Alarm mark

• Color scale band

Setup Items

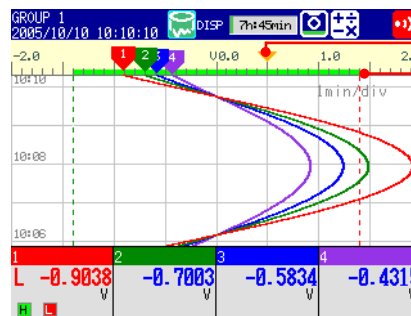

- **First-CH, Last-CH**
Select the target channels. The target channels are common with the other items that are displayed on the screen.

- **Alarm mark**
Displays marks indicating the values of the high and low limit alarms, delay high and low limit alarms, and difference high and low limit alarms. This setting is common with the bar graph display.

• Alarm mark > Mark kind

Settings	Description	Mark
Alarm	The alarm mark is green under normal conditions. It changes to the specified alarm color when an alarm occurs (release number 3 or later; see section 3.7 for details).	▼ or ▲
Fixed	Displays a fixed color.	▼

- **Alarm mark > Indicate on Scale**
To display alarm point marks, select **On**.

• Alarm mark color > Alarm 1, Alarm 2, Alarm 3, and Alarm 4

If the **Mark kind** is set to **Fixed**, specify the color of the alarm point marks. If one of the colors under **Alarm mark color** is set to **Auto**, its corresponding point mark will appear in the specified alarm color (release number 3 or later; see section 3.7 for details).

5.8 Displaying Alarm Point Marks and Color Scale Band on the Scale

- **Color scale band**

Displays a specified section of the measurement range using a color band on the scale. This setting is common with the bar graph display.

- **Color scale band > Band area**

Settings	Description
In	Displays the area inside using the color band.
Out	Displays the area outside using the color band.
Off	Disables the function.

- **Color scale band > Color**

Set the display color.

- **Color scale band > Display position > Lower, Upper**

Specify the display position. Set a value within the span or scale range.

Lower: Lower limit of the area.

Upper: Upper limit of the area.

5.9 Partially Expanding the Waveform

Partially expand a waveform (reduce the other sections) on the display. We recommend that you display the scale when viewing partially expanded channels. The numbers for the ends of the scale and the boundary position are displayed, and you can identify the expanded and reduced areas easily. However, numbers are not displayed for other scale marks.

For a description of the function, see section 1.3.

Setup Screen

- **Turning ON/OFF the Partial Expanded Display Function**

Press **MENU** (to switch to setting mode), hold down **FUNC** for 3 s (to switch to basic setting mode), and select the **Environment** tab > **View, Message**.

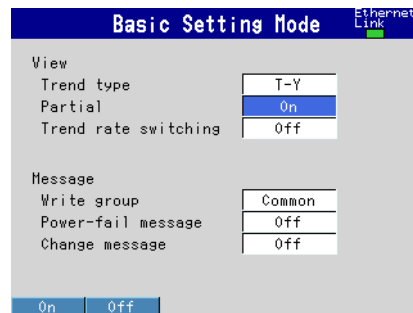

- **Partially Expanded Display Method**

Press **MENU** (to switch to setting mode), and select the **Menu** tab > **Meas channel** > **Partial**.

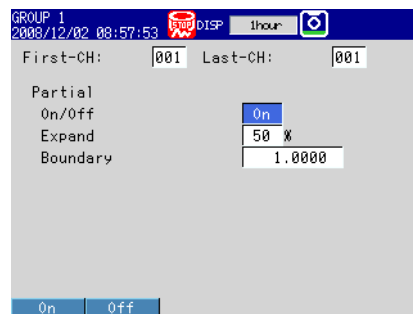

Setup Items

- **View > Partial**

If you select **On**, the **Partial** setup item appears in the setting mode.

- **First-CH, Last-CH**

Select the target channels.

- **Partial > On/Off**

To enable partial expanded display, select **On**.

- **Partial > Expand**

Set the position where the value specified by **Boundary** is to be displayed within the display span in the range of 1 to 99.

5.9 Partially Expanding the Waveform

- **Partial > Boundary**

Set the value that is to be the boundary between the reduced section and the expanded section in the range of “minimum span value + 1 digit to maximum span value – 1 digit.” For channels that are set to scaling, the selectable range is “minimum scale value + 1 digit to maximum scale value – 1 digit.”

Example: Input range: –6 V to 6V. Expand: 30. Boundary: 0

The –6 V to 0 V range is displayed in the 0% to 30% range, and the 0 V to 6 V range is displayed in the 30% to 100% range.

5.10 Changing the Display Layout, Clearing of the Waveform at Start, Message Display Direction, Waveform Line Width, and Grid

Change the display layout, clearing of the waveform at start, waveform line width, and grid.

For a description of the function, see section 1.3.

Setup Screen

Press **MENU** (to switch to setting mode), and select the **Menu** tab > **Display** > **Trend**.

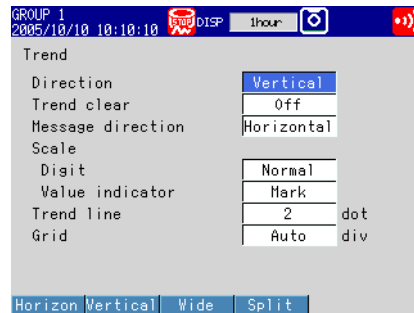

Setup Items

- **Trend > Direction**

Set the display direction of the trends to **Horizontal**, **Vertical**, **Wide**, or **Split**.

- **Trend > Trend clear**

Settings	Description
On	Clears the displayed waveform when the memory sampling is started.
Off	Does not clear the waveform when the memory sampling is started.

- **Trend > Message direction**

Set the display direction of messages to **Horizontal** or **Vertical**. When the trend is set to **Vertical**, the message direction is fixed to **Horizontal**.

- **Trend > Trend line**

Set the line width of the trend in dots (1 to 3).

- **Trend > Grid**

Select the number of grids to be displayed in the waveform display area of the trend display.

Settings	Description
4 to 12	Displays a grid that divides the display width into 4 to 12 sections.
Auto	Displays the same number of grids as the number of scale divisions of the first assigned channel of the group.

5.11 Changing the Bar Graph Display Method

Change the bar graph display method.

For a description of the function, see section 1.3.

Setup Screen

- **Display Direction**

Press **MENU** (to switch to setting mode), and select the **Menu** tab > **Display** > **Bar graph**.

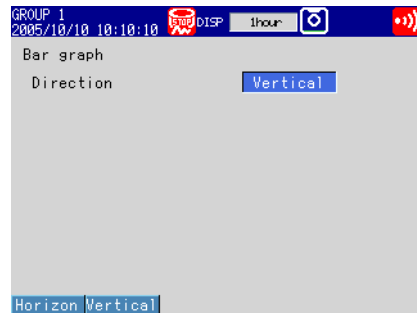

- **Base Position and the Number of Scale Divisions**

Press **MENU** (to switch to setting mode), and select the **Menu** tab > **Meas channel** > **Bar graph**.

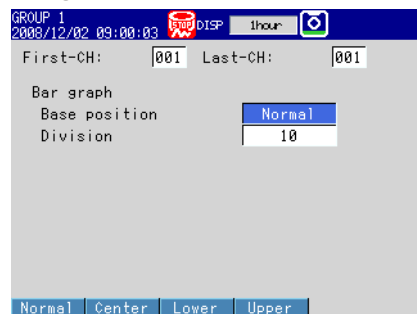

Setup Items

- **Bar graph > Direction**

Set the display direction of bar graphs to **Horizontal** or **Vertical**.

- **First-CH, Last-CH**

Set the target channels. The target channels are common with the other items that are displayed on the screen.

- **Bar graph > Base position**

Set the base position of bar graphs to **Normal**, **Center**, **Lower**,* or **Upper**.*

The setting is applied when displaying the bar graph and when displaying the current value on the scale using the bar graph.

* You can select Lower and Upper on DXs with release number 2.

When the Display Direction of the Bar Graph Is Vertical

- Normal
 Value at the bottom of the bar graph: Span lower limit or span upper limit (or scale lower limit or scale upper limit), whichever is less
 Value at the top of the bar graph: Span lower limit or span upper limit (or scale lower limit or scale upper limit), whichever is greater
 Starting point of the bar: Bottom edge
- Center
 Value at the bottom of the bar graph: Same as with Normal.
 Value at the top of the bar graph: Same as with Normal.
 Starting point of the bar: Center
- Lower
 Value at the bottom of the bar graph: Span lower limit (or scale lower limit)
 Value at the top of the bar graph: Span upper limit (or scale upper limit)
 Starting point of the bar: Bottom edge
- Upper
 Value at the bottom of the bar graph: Same as with Lower.
 Value at the top of the bar graph: Same as with Lower.
 Starting point of the bar: Top edge

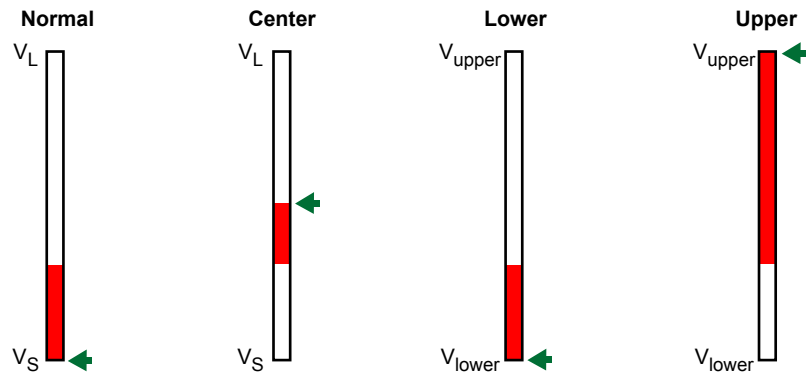

Vupper: Span upper limit (or scale upper limit)
 Vlower: Span lower limit (or scale lower limit)
 VL: Vlower or Vupper, whichever is greater
 VS: Vlower or Vupper, whichever is less
 ◀: Starting point of the bar

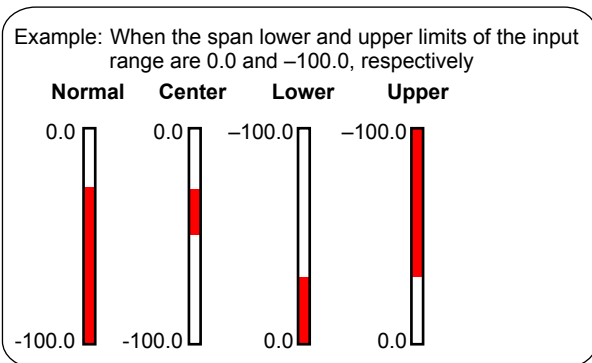

5.11 Changing the Bar Graph Display Method

When the Display Direction of the Bar Graph Is Horizontal

The span lower limit (or scale lower limit) becomes the left edge of the bar graph, and the span upper limit (or scale upper limit) becomes the right edge of the bar graph.

- Starting point of the bar
 - Normal: Left edge or right edge, whichever is less
 - Center: Center
 - Lower: Left edge
 - Upper: Right edge

Normal

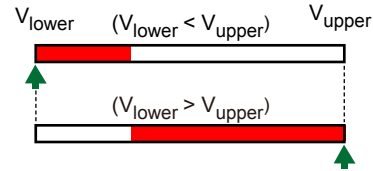

Lower

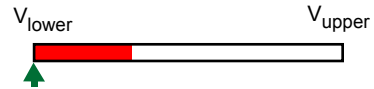

Center

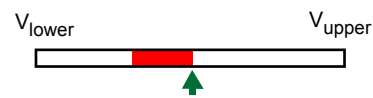

Upper



V_{upper} : Span upper limit (or scale upper limit)
 V_{lower} : Span lower limit (or scale lower limit)
 ▲: Starting point of the bar

Example: When the span lower and upper limits of the input range are 0.0 and -100.0, respectively

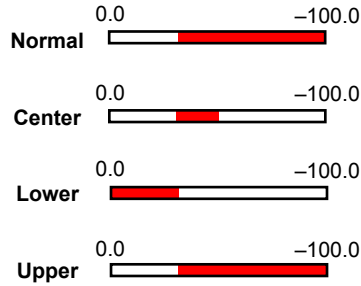

When Displaying the Current Value on the Scale Using the Bar Graph

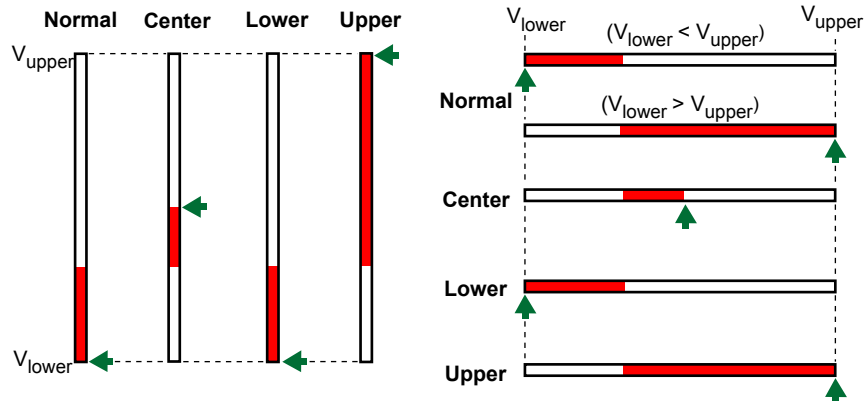

- Bar graph > Division**

Select the number of main scale marks from 4 to 12.

5.12 Changing the Background Color of the Display

Change the background color of the display. This setting is applied to the operation screens.

Setup Screen

Press **MENU** (to switch to setting mode), and select the **Menu** tab > **Display** > **Monitor**.

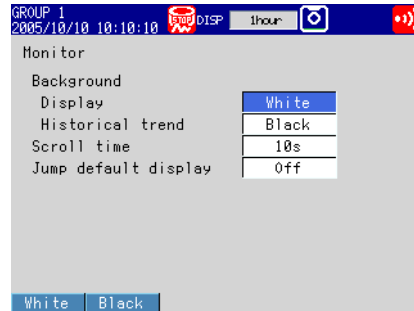

Setup Items

- **Monitor > Background > Display**
Set the background color of the operation screen to **White** (default setting) or **Black**.
- **Monitor > Background > Historical trend**
Select the background color of the historical trend display from the following:
Settings: **White**, **Black** (default setting), **Cream**, and **Lightgray**

5.13 Automatically Switching Display Groups

Automatically switch the displayed group at a specified interval.

Setup Screen

Press **MENU** (to switch to setting mode), and select the **Menu** tab > **Display** > **Monitor**.

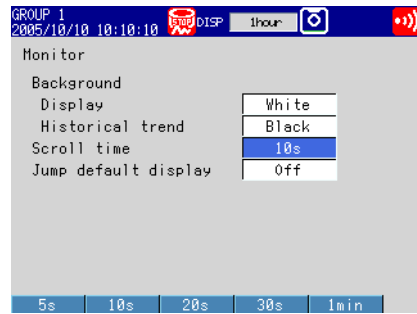

Setup Items

- **Monitor > Scroll time**
Set the switching interval from the available settings between 5 s and 1 min. The groups switch in ascending order.
Select whether to automatically switch on the display selection menu.
See section 4.2

5.14 Automatically Switching Back to the Default Display

Show a preset display when there is no operation for a specific time.

Setup Screen

Press **MENU** (to switch to setting mode), and select the **Menu** tab > **Display** > **Monitor**.

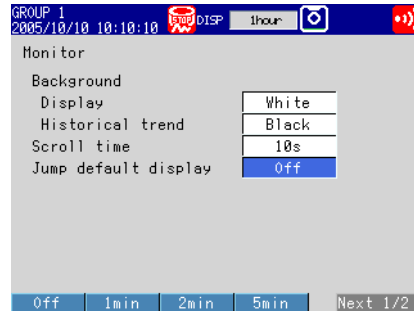

Setup Items

- **Monitor > Jump default display**

Returns to a preset display if there is no key operation for a specific time.

Settings	Description
1min to 1h	Time until switching the display.
Off	Disables the function.

Procedure

- **Specifying the Display to be Shown**

1. Show the operation display you want to designate.
2. In the operation mode, press **FUNC**.
The FUNC key menu appears.
3. Press the **Standard display** soft key.
The display is registered.

5.15 Using the Favorite Key

Register a frequently used display to the Favorite key and enable the display to be shown through simple operation.

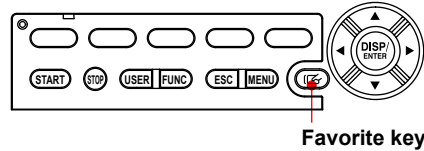

Favorite key

Setup Screen

- **FAVORITE Key action (Release number 3 or later)**
Press **MENU** (to switch to setting mode), and select the **Menu** tab > **Display** > **FAVORITE Key action**.

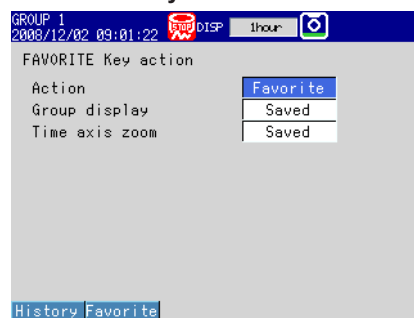

Setup Items

- **Action (Release number 3 or later)**

Setting	Description
History	The historical trend of the currently displayed data appears when you press the favorite key.
Favorite	The displays that have been registered to the favorite key appear when you press the favorite key. Select Favorite when you want to register displays to the favorite key and use it to switch between them.

If you are using the multi batch function (/BT2 option), see the *DX1000/DX1000N/DX2000 Multi Batch (/BT2) User's Manual, IM04L41B01-03E*.

- **Group display (Release number 3 or later)**

Specify this setting when Action is set to Favorite.

Setting	Description
Current	Of the displays that have been registered to the favorite key, those that display groups (the trend, digital, bar graph, and historical trend displays) are displayed using the currently displayed group.
Saved	Registered displays are displayed as they were registered.

- **Time axis zoom (Release number 3 or later)**

Specify this setting when Action is set to Favorite.

Setting	Description
Current	Historical trend displays that have been registered to the favorite key are displayed using the current time axis zoom.
Saved	Historical trends are displayed using the time axis zooms that they were registered with.

Procedure**• Registering the Display**

Up to 8 displays can be registered.

1. In the operation mode, show the display you want to register.
2. Press **FUNC**.
The FUNC key menu appears.
3. Press the **Favorite regist** soft key. Then, press a registration number **soft key**.
4. Press the **Regist** soft key.
A window appears for you to enter the display name.
* To delete a registration, press the **Delete** soft key.
5. Enter the display name (using up to 16 characters, - 6. Select **ENT** and press **DISP/ENTER**.
The display is registered.

• Switching the Display**When You Set Action to History**

The historical trend of the currently displayed data appears when you press the favorite key. Press the key again to return to the previous display.

When You Set Action to Favorite

The displays change in the order that they were registered in each time you press the favorite key. Pressing the favorite key after the last registered display appears returns the display to what it was before the favorite key was pressed.

5.16 Writing a Message When the DX Recovers from a Power Failure

A message is written to the trend display when the DX recovers from a power failure while memory sampling is in progress.

Setup Screen

- **Power-fail message**

Press **MENU** (to switch to setting mode), hold down **FUNC** for 3 s (to switch to basic setting mode), and select the **Environment** tab > **View, Message**.

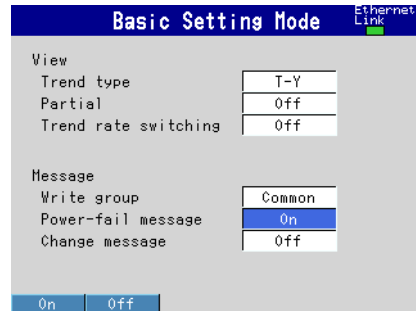

Setup Items

- **Message > Power-fail message**

Settings	Description
On	A message is written when the DX recovers from a power failure while memory sampling is in progress. Display example: 15:12 Power Off 2005/10/25 15:12:57
Off	Disables the function.

If you are using the multi batch function (/BT2 option), see *the DX1000/DX1000N/DX2000 Multi Batch (/BT2) User's Manual, IM04L41B01-03E*.

5.17 Changing the FUNC Key Menu and Display Selection Menu

Change the FUNC key menu that appears when the FUNC key is pressed and the display selection menu that appears when the DISP/ENTER key is pressed. If you are using the multi batch function (/BT2 option), see the *DX1000/DX1000N/DX2000 Multi Batch (/BT2) User's Manual, IM04L41B01-03E*.

Setup Screen

- **FUNC Key Menu**

Press **MENU** (to switch to setting mode), and select the **Menu** tab > **Menu customize** > **Function menu**.



Number indicating the display order

Message

Menu name
White: Used
Gray: Not used

- **Display Menu**

Press **MENU** (to switch to setting mode), and select the **Menu** tab > **Menu customize** > **Display menu**.

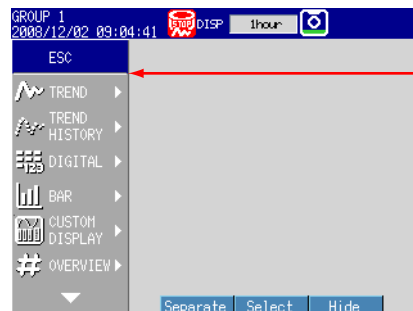

Separator

Setup Items

- **Enabling/Disabling the FUNC Key Menu**

Items whose menu name is white are shown.

1. Press the **arrow keys** to select a menu item.
2. Press the **View** or **Hide** soft key.

If you press the **Hide** soft key, the menu name is displayed in gray, and does not appear in the FUNC key menu.

- **Changing the Display Order of the FUNC Key Menu**

Menu items are displayed in order by number. In addition, menu items appear when the corresponding function can be used.

1. Press the **arrow keys** to select a menu item.
2. Press the **Select** soft key.
The menu item is enclosed in a red frame.
3. Press the **arrow keys** to select the destination.
4. Press the **Transfer** soft key.
The menu item moves to the selected number position.

5.17 Changing the FUNC Key Menu and Display Selection Menu

- **Description of the FUNC Key Menus**

For a description of each item, see section 4.1.
- **Enabling/Disabling the Display Selection Menu and Sub Menu**

Items whose menu name is white are shown.

 1. Press the **arrow keys** to select a menu item.
 2. Press the **View** or **Hide** soft key.

If you press the **Hide** soft key, the menu name is displayed in gray, and does not appear in the display selection menu.
- **Changing the Display Selection Menu/Sub Menu Positions**
 1. Press the **arrow keys** to select a menu item.
 2. Press the **Select** soft key.

The menu item is enclosed in a red frame.
 3. Press the **arrow keys** to select the destination.
 4. Press the **Transfer** soft key.

The menu item moves to the selected position.
- **Showing/Hiding Separators**
 1. Press the **arrow keys** to select a menu item.
 2. Press the **Separate** soft key.

A separator (line) is displayed between the current item and the lower item.
If you select a menu item whose separator is already shown, this operation hides the separator.
You can set up to three separators in the display selection menu and each sub menu.

- **Description of the Display Selection Menus and Sub Menus**

Items with asterisk (*) are set to **Hide** by default.

Display Selection Menu	Sub Menu	Reference Section
TREND	GROUP 1 to GROUP 10	Section 4.2
	ALL CHANNEL/GROUP CHANNEL	Section 4.2
	SCALE ON/OFF	Section 4.2
	DIGITAL OFF/ON	Section 4.2
	MESSAGE DISP2/1	Section 4.2
	* TREND SPACE ON/OFF	Section 4.2
	AUTO SCROLL ON/OFF	Section 4.2
	FINE GRID ON/OFF	Section 4.2
	AUTO ZONE ON/OFF	Section 4.2
	TAG DETAIL ON/OFF	Section 4.2
TREND HISTORY	GROUP 1 to GROUP 10	Section 4.3
DIGITAL	GROUP 1 to GROUP 10	Section 4.2
	AUTO SCROLL ON/OFF	Section 4.2
	TAG DETAIL ON/OFF	Section 4.2
BAR	GROUP 1 to GROUP 10	Section 4.2
	AUTO SCROLL ON/OFF	Section 4.2
	TAG DETAIL ON/OFF	Section 4.2
CUSTOM DISPLAY	INTERNAL 1 to INTERNAL 3, EXTERNAL 1 to EXTERNAL 25	IM04L41B01-04E
	NEW	IM04L41B01-04E
OVERVIEW	CURSOR OFF/ON	Section 4.4
	JUMP TO ALM SUM	Section 4.4
	JUMP TO TREND	Section 4.4
	* JUMP TO DIGITAL	Section 4.4
	* JUMP TO BAR	Section 4.4
	TAG DETAIL ON/OFF	Section 4.4
	ACK ALARM 1 ¹²	Section 4.4
	ACK ALARM 2 ¹²	
ACK ALARM 3 ¹²		
ACK ALARM 4 ¹²		
ANNUNCIATOR	—	Section 3.12

5.17 Changing the FUNC Key Menu and Display Selection Menu

Display Selection Menu	Sub Menu	Reference Section
INFORMATION	ALARM SUMMARY	Section 4.5
	MESSAGE SUMMARY	Section 4.5
	MEMORY SUMMARY	Section 4.5
	TAG DETAIL ON/OFF	Section 4.6
	* MODBUS CLIENT	Section 4.5
	* MODBUS MASTER	Section 4.5
	* RELAY	Section 4.5
	EVENT SWITCH	Section 4.5
	REPORT DATA	Section 4.5
	COLUMN BAR	Section 4.10
	TO HISTORY	Sections 4.6, 4.7, and 4.8
	TO HISTORY(DISP)	Sections 4.6, 4.7, and 4.8
	TO HISTORY(EV)	Sections 4.6, 4.7, and 4.8
	TO OVERVIEW	Section 4.6
	DISP GROUP OFF/ON	Section 4.7
	CHANGE SORT KEY	Sections 4.6 and 4.7
	ASCENDING ORDER/ DESCENDING ORDER	Sections 4.6 and 4.7
	DATA SAVE MODE	Section 4.8
	SELECT SAVE	Section 4.8
	* M.SAMPLE SAVE	Section 4.8
	* REPORT SAVE	Section 4.8
	ALL SAVE	Section 4.8
	CHANGE DISP ITEM	Section 4.7
	CHANGE DATA KIND	Section 4.8
	FILENAME DISPLAY/TIME DISPLAY	Section 4.8
	CHANGE REPORT CH	Section 4.5
	SINGLE GRAPH/DUAL GRAPH	Section 4.10
SELECT COLUMN/SELECT GROUP	Section 4.10	
REPORT GROUP 1 to 6	Section 4.10	
*Log	LOGIN ^{*1}	Section 4.9
	Operation ^{*2}	Section 4.9
	ERROR	Section 4.9
	COMMUNICATION	Section 4.9
	FTP	Section 4.9
	MAIL	Section 4.9
	WEB	Section 4.9
	SNTP	Section 4.9
	DHCP	Section 4.9
	MODBUS	Section 4.9
	Change settings ^{*2}	Section 4.9
	CHANGE DISP ITEM ^{*2}	Section 4.9

*1 Only on DXs without the /AS1 advanced security option

*2 Only on DXs with the /AS1 advanced security option

5.18 Displaying Comments (Release number 3 or later)

Register text strings to comment text fields and combine comment text fields to create comment text blocks.

- You can display the text from a comment text block when a certain event occurs (an alarm for example).
- You can use comment text block text for annunciator window labels (see section 3.12 for details).

Setup Screen

• Entering Comments

Press **MENU** (to switch to setting mode), and select the **Menu** tab > **Message, Comment Text** > **Comment text fields**.

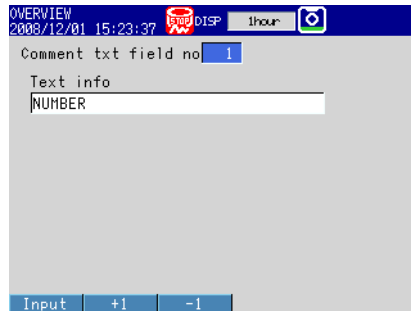

Press **MENU** (to switch to setting mode), and select the **Menu** tab > **Message, Comment Text** > **Comment txt block**.



• Displaying Comments

Press **MENU** (to switch to setting mode), and select the **Menu** tab > **Timer, Event action** > **Event action**.

See section 7.1.

5.18 Displaying Comments (Release number 3 or later)

Setup Items

- Comment txt field no, Text info**
 You can register a comment to a specified comment text field (field 1 to 100).
 Text info: you can enter up to 32 characters (Aa#1).
- Comment txt block no, Comment txt field no**
 You can register a comment to a specified comment text block (block 1 to 50).
 Register comments to comment text blocks by combining up to 5 comment text fields.
 The text from the selected comment text fields appears on the right of the screen.
- Logic box number, Event, Action, Comment Txt Block No**
 Use the event action function to specify the event that will cause a comment to be displayed. For information about how to set the event action function, see section 7.1.
 Example: If even one alarm occurs, the text from comment text block 2 is displayed.

Item	Setting
Event	Alarm
Action	CommentDisplay
Comment Txt Block No	2

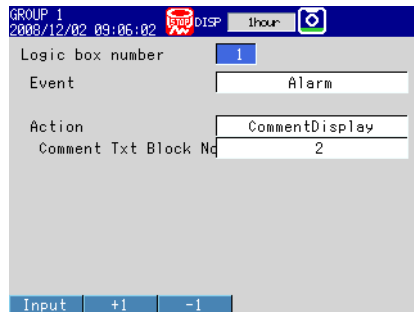

A comment appears when an alarm occurs. Pressing any key makes the comment disappear.

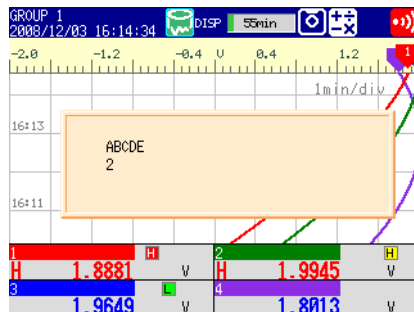

6.1 Setting the Recording Conditions of the Measured Data

Set the method for recording the measured data.
For a description of the function, see section 1.4.

Setup Screen

- **Data Type**

Press **MENU** (to switch to setting mode), hold down **FUNC** for 3 s (to switch to basic setting mode), and select the **Menu** tab > **A/D, Memory**.

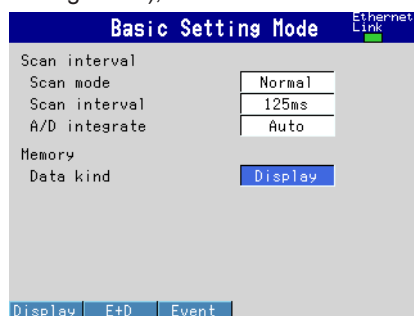

- **Measurement Channels**

Press **MENU** (to switch to setting mode), and select the **Menu** tab > **Meas channel** > **Tag, Memory, Delay**.

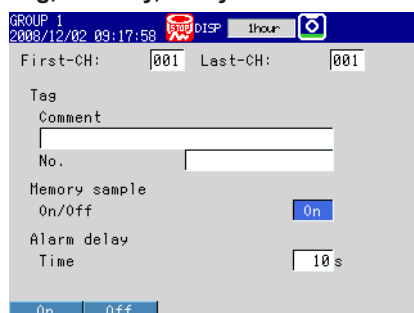

- **File Save Interval (Display Data)**

Press **MENU** (to switch to setting mode), and select the **Menu** tab > **Display** > **Trend/Save interval**.

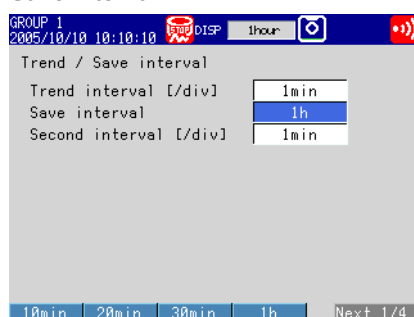

6.1 Setting the Recording Conditions of the Measured Data

- **Recording Conditions of Event Data**

Press **MENU** (to switch to setting mode), and select the **Menu** tab > **Data save** > **Event data**.

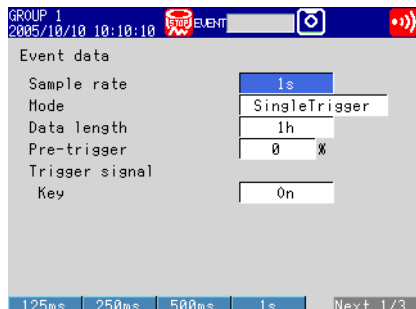

Setup Items

- **Memory > Data kind**

Settings	Description
Display	Records display data.
E+D	Records display data and event data. This setting cannot be selected when the trend interval switching function is set to On. This setting cannot be selected when the multi batch function (/BT2 option) is being used or on DXs with the /AS1 advanced security option.
Event	Records event data.

- **Memory sample > On/Off**

Turn **On** the target channels.

- **Trend/Save interval > Trend interval [/div] (when recording display data)**

See the table below. You can only set trend intervals that are longer than the scan interval you set in Basic Setting Mode.

- **Trend/Save interval > Save interval (when recording display data)**

Select the size of a record data file. The recorded data is divided by the file size specified here. The available settings vary depending on the number of memory sampling channels and the **Trend interval** setting.

Trend interval^{*1}	5 s^{*2}	10 s^{*2}	15 s^{*3}	30 s	1 min
Sample rate	125 ms	250 ms	500 ms	1 s	2 s
Selectable range of auto save interval	10 min to 12 hours	10 min to 1 day	10 min to 3 days	10 min to 7 days	10 min to 14 days
Trend interval^{*1}	2 min	5 min	10 min	15 min	20 min
Sample rate	4 s	10 s	20 s	30 s	40 s
Selectable range of auto save interval	10 min to 14 days	10 min to 31 days	10 min to 31 days	10 min to 31 days	1 hour to 31 days
Trend interval^{*1}	30 min	1 h	2 h	4 h	10 h
Sample rate	1 min	2 min	4 min	8 min	20 min
Selectable range of auto save interval	1 hour to 31 days	1 hour to 31 days	2 hours to 31 days	4 hours to 31 days	8 hours to 31 days

*1 You cannot set a trend interval that corresponds to a sampling interval that is faster than the scan interval.

*2 Selectable on the DX1002, DX1002N, DX1004, and DX1004N (release number 3 or later).

*3 Selectable in fast sampling mode on the DX1006, DX1006N, DX1012, and DX1012N (release number 3 or later).

- **Trend/Save interval > Second interval [/div]**

See section 5.3.

- **Event data (when recording event data)**

- **Sample rate**

Select the data recording interval. Use the table under “Data length” for reference.

- **Mode**

Settings	Description
Free	Records data continuously.
Single	Records data when the trigger condition is met.
Repeat	Records data each time the trigger condition is met.

* This setting is fixed at “Free” when the multi batch function (/BT2 option) is being used and on DXs with the /AS1 advanced security option.

- **Data length**

Select the size of a record data file. The recorded data is divided by the file size specified here. The available data lengths vary depending on the number of memory sampling channels and the **Sample rate** setting.

Sample rate ^{*1}	25 ms ^{*2}	125 ms	250 ms	500 ms	1 s
Selectable range of data length	10 min to 4 hours	10 min to 1 day	10 min to 2 days	10 min to 3 days	10 min to 7 days
Sample rate ^{*1}	2 s	5 s	10 s	30 s	1 min
Selectable range of data length	10 min to 14 days	10 min to 31 days	10 min to 31 days	1 hour to 31 days	1 hour to 31 days
Sample rate ^{*1}	2 min	5 min	10 min	15 min ^{*3}	20 min ^{*3}
Selectable range of data length	1 hour to 31 days	1 hour to 31 days	1 hour to 31 days	1 hour to 31 days	1 hour to 31 days
Sample rate ^{*1}	30 min ^{*3}				
Selectable range of data length	1 hour to 31 days				

*1 You cannot choose an interval that is faster than the scan interval.

*2 Selectable on the DX1002, DX1002N, DX1004, and DX1004N.

*3 Release number 3 or later.

- **Pre-trigger**

Specify the range when recording data before the trigger condition is met. Select the range as a percentage of the data length from **0, 5, 25, 50, 75, 95, and 100%**. If you do not want to record the data existing before the trigger condition is met, select **0%**.

- **Trigger signal > Key**

Select **On** if you want to activate the trigger using key operation.

Note

- Triggers can be applied using event action (see section 7.1).
- If the trigger condition is already met when you press START, recording starts.

6.2 Setting the Method for Saving the Data

Set the method for recording the measured data to the storage medium.
For a description of the function, see section 1.4.

Setup Screen

- **Auto save**

Press **MENU** (to switch to setting mode), hold down **FUNC** for 3 s (to switch to basic setting mode), and select the **Environment** tab > **Security, Media save**.

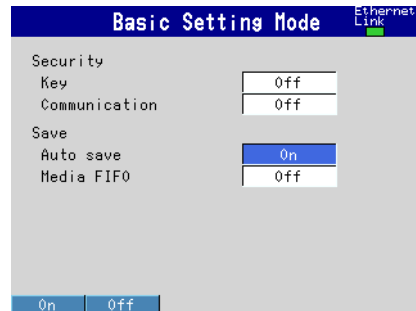

- **File header, Data file name**

Press **MENU** (to switch to setting mode), and select the **Menu** tab > **Data save** > **File header, File name**.

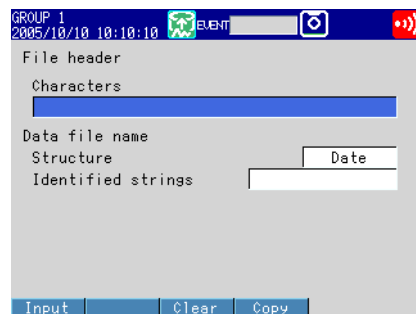

- **Save directory**

Press **MENU** (to switch to setting mode), and select the **Menu** tab > **Data save** > **Save directory**.

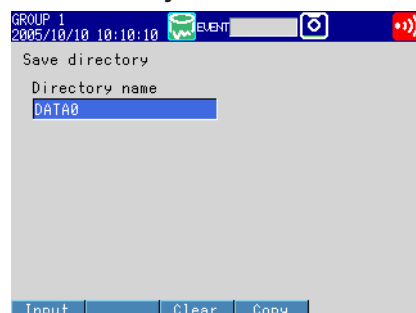

Setup Items

- **Save > Auto save**

Settings	Description
On	Automatically saves the measured data to the CF card. Specify On to enable the media FIFO function.
Off	Does not automatically save the data. Save the measured data manually to the CF card or USB flash memory (/USB1 option).

- **Save > Media FIFO (Release Number 2 or Later)**

This item appears if Auto save is set to On.

Settings	Description
On	Enable media FIFO. Constantly retains the most recent data files in the CF card.
Off	Disable media FIFO. Replace the CF card if the free space on the CF card drops low.

- **File header > Characters**

Set the header comment to be written to the data file. (Up to 50 characters, $[Aa\#1]$)

- **Data file name > Structure**

Sets the structure of the file name when saving data.

Settings	Description
Date	Serial number + user-assigned character string + date
Serial	Serial number + user-assigned character string
Batch	Serial number + batch name (when using the batch function)

- **Data file name > Identified strings**

Set the user-assigned section of the file name. (Up to 16 characters, $[Aa\#1]$)

Symbols that can be used: #, %, (,), +, -, ., @, °, and _.

For details on the data file name, see section 1.4.

- **Save directory > Directory name**

Set the name of the directory on the storage medium for saving the data on the external storage medium. (Up to 20 characters, $[Aa\#1]$)

Symbols that can be used: #, %, (,), +, -, ., @, °, and _.

Strings that cannot be used: AUX, CON, PRN, NUL, CLOCK, COM1 to COM9, and LPT1 to LPT9.

6.3 Using the Batch Function

Set the batch function.

For a description of the function, see section 1.5.

Setup Screen

- **Batch Function**

Press **MENU** (to switch to setting mode), hold down **FUNC** for 3 s (to switch to basic setting mode), and select the **Environment** tab > **Batch**.

The screenshot shows the 'Basic Setting Mode' screen. At the top, it says 'Basic Setting Mode' and 'Ethernet Link' with a green indicator. Below this, there are three rows of settings: 'Batch' with a value of 'On', 'Lot-No. digit' with a value of '6', and 'Auto increment' with a value of 'On'. At the bottom, there are two buttons: 'On' and 'Off'.

- **Data file name**

Press **MENU** (to switch to setting mode), and select the **Menu** tab > **Data save** > **File header, File name**.

The screenshot shows the 'Data file name' setup screen. At the top, it says 'GROUP 1' and '2005/01/01 02:01:05'. Below this, there are three tabs: 'Date', 'Serial', and 'Batch'. The 'Batch' tab is selected. The screen shows 'File header' and 'Characters' with a text input field. Below this, there is 'Data file name' and 'Structure' with a 'Batch' button. At the bottom, there are three buttons: 'Date', 'Serial', and 'Batch'.

- **Text Field**

Press **MENU** (to switch to setting mode), and select the **Menu** tab > **Data save** > **Batch text**.

The screenshot shows the 'Text Field' setup screen. At the top, it says 'GROUP 1' and '2005/01/01 02:01:43'. Below this, there are three tabs: 'Date', 'Serial', and 'Batch'. The 'Batch' tab is selected. The screen shows 'Text field number' with a value of '1', 'Title of field' with a text input field, and 'Characters' with a text input field. At the bottom, there are three buttons: 'Input', 'Clear', and 'Copy'.

Setup Items

- **Batch > On/Off**
Select **On** to use the batch function.
For details on **MultiBatch**, see *IM04L41B01-03E*.
- **Batch > Lot-No. digit**
Select the number of digits of the lot number from 4, 6, or 8. Select Off to disable the lot number.

- **Batch > Auto increment**

Settings	Description
On	Automatically sets the lot number of the next measurement to “the lot number of the current measurement + 1.”
Off	Disables the operation described above.

- **Data file name > Structure**
Batch: Sets the name of the display data files or event data files to “batch name.”
For details on the data file name, see section 1.4.
- **Text field number**
Select a number from 1 to 24 on a DX whose release number is 3 or later. Select a number from 1 to 8 on a DX whose release number is 2 or earlier.
- **Text field > Title of field or Characters**
Set the string.
Title of field: (Up to 20 characters, $\boxed{\text{Aa}\#\text{1}}$), Characters: (Up to 30 characters, $\boxed{\text{Aa}\#\text{1}}$)

Procedure

- **Setting the Batch Name (Batch number + lot number) and Comment**
 1. In the operation mode, press **FUNC**.
The FUNC key menu appears.
 2. Press the **Batch** soft key.
A window appears for you to enter the batch name and comment.
 3. Set the batch number. (Up to 32 characters, $\boxed{\text{Aa}\#\text{1}}$)
Symbols that can be used: #, %, (,), +, -, ., @, °, and _.

If you are using the lot number, set the lot number.
 4. Set batch comments 1, 2, and 3. (Up to 50 characters each, $\boxed{\text{Aa}\#\text{1}}$)
 5. Press **DISP/ENTER**.

Note

- Batch numbers and lot numbers cannot be changed after memory start.
- You can change the comment as many times as you wish before executing memory start. After memory start, only the comments that are not specified can be entered. You can change the comment as many times as you wish while the window for setting the comment is displayed. The last specified comment is valid.
- The comment is cleared when memory stop is executed.
- The text fields set upon memory start (see “Starting Recording (Memory Start)” on the next page) are cleared upon memory stop.
- The batch number, lot number, and comments are saved to the display data file or event data file. They are not saved to the setup file.

6.3 Using the Batch Function

- **Displaying the Text Field Settings**

If you are using the multi batch function (/BT2 option), see *the DX1000/DX1000N/DX2000 Multi Batch (/BT2) User's Manual, IM04L41B01-03E*.

1. In the operation mode, press **FUNC**.
The FUNC key menu appears.
2. Press the **Text field** soft key.
The text field settings are displayed.

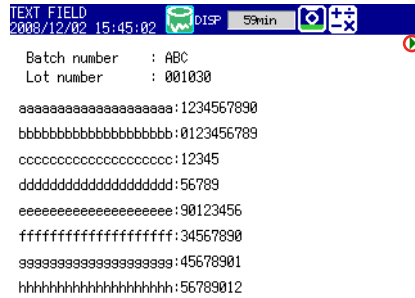

Page switch mark (release number 3 and later)
Eight text fields are displayed on a single page.
Use the **left and right arrow keys** to switch the page.

The text field contents are displayed on page 3. Use the **left and right arrow keys** to switch pages (release number 3 or later).

- **Starting Recording (Memory start)**

1. Press **START** to open the start recording screen (release number 3 or later).
* On DXs with the /AS1 advanced security option, recording will not start, even if you press START in setting mode.



2. Enter the batch number, lot number, and comments.
To edit the contents of a text field, proceed to step 3.

3. Select **Input**, and press **DISP/ENTER**. The text field screen appears (release numbers 4 and later).

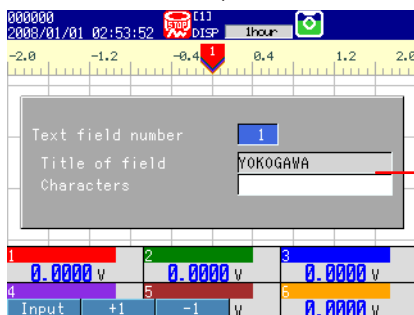

The settings that you made in setting mode appear here.

Select a text field number, and enter text. However, you cannot specify the Title of field. (Firmware version numbers 4.11 and later)

Press **DISP/ENTER**.

The start recording screen will appear.

If you press the **+1** and **-1** soft keys to increase and decrease the text field number, any text field numbers whose Title of field have not been set will be skipped. If you press the **Input** soft key to enter text field numbers directly, any text field numbers whose Title of field have not been set are also displayed.

The text fields that you specify here will only be saved to the measured data file whose recording you are starting. The text fields that you set in setting mode (see page 6-6) will not change.

4. Move the cursor (blue) to **START**, and then press **DISP/ENTER**.
The internal memory icon in the status display section changes from the icon that indicates that memory sampling is stopped to the icon that indicates that memory sampling has started.
 - If you are recording display or event data in Free mode, recording will start.
 - If you are recording event data in a trigger mode (Single or Repeat), the DX will enter a trigger-wait state.

• Stopping Recording (Memory stop)

1. Press **STOP**. A confirmation window opens.

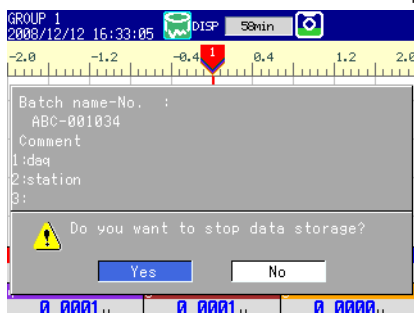

2. Select **Yes**, and press **DISP/ENTER**.

If the DX is equipped with computation functions (/M1 and /PM1 options), select **Mem+Math** or **Memory** and press **DISP/ENTER**.

On DXs with the /AS1 advanced security option, if there are alarms upon which the alarm ACK operation has not been performed, a confirmation message will appear. Perform the alarm ACK operation as necessary.

The internal memory icon in the status display section changes to the icon that indicates that memory sampling is stopped.

6.4 Starting/Stopping the Recording and Saving the Measured data

Start the recording and save the measured data to the external storage medium.
For a description of the function, see section 1.4.

Procedure

- **Starting the Recording (Memory Start)**

Press **START**. The internal memory icon in the status display section changes from the stop icon to memory sampling icon.

- When recording display data or event data in free mode, recording starts.
- When recording event data in trigger mode, the DX enters the trigger-wait condition.
 - * On DXs with the /AS1 advanced security option, recording will not start, even if you press **START** in setting mode.
 - * For the procedures when using the batch function, see section 6.3. If you are using the multi batch function (/BT2 option), see the *DX1000/DX1000N/DX2000 Multi Batch (/BT2) User's Manual, IM04L41B01-03E*.

- **Applying a Trigger to Start the Recording**

Carry out the procedure below when the DX is waiting for a trigger.

Trigger through Key Operation

The procedure below can be carried out when recording event data in trigger mode and the DX is configured so that the start trigger is applied through key operation.

1. Press **FUNC**.
The FUNC key menu appears.
2. Press the **Trigger** soft key.
The recording starts.

Trigger by an Event (Event action function must be configured. See section 7.1.)

Recording starts when an event occurs.

- **Automatically Saving Measured Data**

Automatic saving takes place when **Auto save** is set to **On** (see section 6.2 for details). The save destination is the CF card.

Have the CF card inserted in the slot at all times. While the memory sampling is in progress, the measured data recorded in the internal memory is automatically saved to the CF card.

Action when Media FIFO is not enabled: If data storage to the storage medium is not complete such as due to insufficient free space, the unsaved data is saved the next time the data is automatically saved.

Saving the Display Data or Event Data during Memory Sampling through Key Operation

The save destination is the CF card.

This operation can be carried out when recording display data or when recording event data in **Free** mode. Unsaved measured data is saved to the CF card.

- * If this operation is carried out when auto save is Off, the data in the internal memory is divided, and a file is created.

1. In the operation mode, press **FUNC**.
The FUNC key menu appears.
2. Press the **Save display** or **Save event** soft key.
The display data or event data is saved to the CF card.

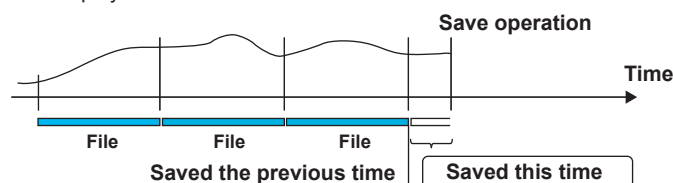

- **Saving Measured Data Manually (Collectively Storing Unsaved Data)**

Automatic saving takes place when **Auto save** is set to **Off** (see section 6.2 for details). You can save to a CF card or to USB flash memory (/USB1 option). The procedure for saving unsaved data to a CF card is described below.

For the procedure to save data to the USB flash memory, see section 2.12.

1. Insert the CF card.

A confirmation window containing the message "There is data which is not saved to media. Do you want to store to media?" appears.

2. Select **Yes** and press **DISP/ENTER**.

The unsaved data in internal memory will be saved to the CF card.

3. Follow these steps to remove the CF card.

Press **FUNC** (to display the FUNC key menu) > **Media eject** soft key > **CF** soft key.

When the message "Media can be removed safely" appears, remove the CF card.

Note

- If there is not enough free space on the storage medium, the message "Not enough free space on media" appears, and the data is not saved. If this message appears, replace the storage medium. Then, carry out the procedure again.
- You cannot abort the data save operation while it is in progress.

- **Stopping the Recording (Memory Stop)**

* For the procedures when using the batch function, see section 6.3.

1. Press **STOP**. A confirmation window is displayed.



2. Select **Yes** using the **arrow keys** and press **DISP/ENTER**.

On models with the computation function (/M1 or /PM1 option), select **Mem+Math** or **Memory**, and press **DISP/ENTER**.

On DXs with the /AS1 advanced security option, if there are alarms upon which the alarm ACK operation has not been performed, a confirmation message will appear. Perform the alarm ACK operation as necessary.

The internal memory icon in the status display section changes to the stop icon.

- **Saving the Data in the Internal Memory Collectively or Selectively through Key Operation**

See section 4.8.

Explanation

- **Operations That Start Simultaneously with Memory Start**

- Waveform display updating on the trend display.
- Report (/M1 and /PM1 options)
- The computation function (/M1 and /PM1 options) can be configured to start simultaneously with memory start.
See section 9.4.

- **Operations That Stop Simultaneously with Memory Stop**

- Waveform display updating on the trend display.
- Report (/M1 and /PM1 options)
- Computation function (/M1 and /PM1 options): When selected in the procedure described above.

- **Performance While Data Is Being Saved**

If the internal memory or external storage medium is continuously accessed, the following phenomena may occur. When such phenomena occur, the storage medium access indicator frequently illuminates.

- Files being saved to the external storage medium drop out.
- Accessing the DX through communications takes a long time

In such case, take the following measures.

- If you are creating data files at short intervals consecutively using the event action function, increase the data file save interval.
- If you are creating numerous files in a single directory on the external storage medium, change the destination directory name at approximately every 1000 files.

- **Changing Settings and Performing File Operations during Recording (Memory sampling)**

If you are using the multi batch function (/BT2 option), if even one batch group is being recorded, the DX is recording (memory sampling).

On DXs without the /AS1 advanced security option

You can change all settings except for the ones listed below.

- Basic settings
- Input range
- Memory sampling on/off
- Computation channel calculation expressions and constants
- TLOG
- Trend interval
- File save interval
- Timer and match time timer

On DXs With the /AS1 Advanced Security Option

You can change the following settings and perform the following file operations. The administrator can perform all operations. Users can only perform operations that have been permitted. The setting menu that appears varies depending on the operations that can be performed.

Setting Changes

- Date and time settings
- Alarm settings
- Alarm delay time settings
- Calibration settings
- Destination directory settings
- Administrator settings*
- User settings*

* See the *Advanced Security Function (/AS1) User's Manual, IM 04L41B01-05EN*.

File Operations

- Loading display data files
- Loading event data files
- Listing the files on the external storage medium

6.5 Manually Saving the Measured Data (Manual Sample)

Save the instantaneous values of all channels (excluding those set to Skip or Off) through key operation.

For a description of the function, see section 1.4.

Procedure

1. In the operation mode, press **FUNC**.
The FUNC key menu appears.
2. Press the **Manual sample** soft key.
Manual sampling is executed.

Explanation

- **Number of Manual Sampled Data Set in the Internal Memory**
The number of manual sampled data set in the internal memory is displayed on the memory summary display (see section 1.9)
- **Saving Manual Sampled Data**
 - If auto save is **On**, the manual sampled data is saved to the CF card when you carry out manual sampling.
 - If auto save is **Off**, save the manual sampled data to the CF card according to the procedure for manually saving the data (see section 6.4).
 - The manual sampled data can be saved manually to a CF card or USB flash memory (/USB1 option) regardless of whether the auto save function is set to On/Off. For the manual save operation, see section 4.8.

6.6 Saving the Screen Image Data (Snapshot)

Save the current screen image data to the CF card. This operation is called *snapshot*, and the screen image data file is called *snapshot data file*. For a description of the function, see section 1.4.

Procedure

1. In the operation mode, press **FUNC**.
The FUNC key menu appears.
2. Press the **Snap shot** soft key.
The snapshot data file is saved to the CF card.
Image of the soft keys and the message window are not saved.

Note

If you assign the snapshot function to the USER key, you can carry out snapshots in all modes (operation mode, setting mode, and basic setting mode). However, error messages are not saved.

Explanation

- **File Format**
The snapshot data file is in PNG format.
- **File Name**
See section 1.4.

6.7 Managing the Files on the Storage Medium

This section explains how to display a list of files on the storage medium, check the free space, delete files and directories, and format the storage medium.

Procedure

- **Displaying a List of Files on the Storage Medium, Deleting Files, and Checking the Free Space**

Carry out the procedure below to show the display.

Press **MENU** (to switch to setting mode), and select the **File** tab > **File list, delete** > press the **CF** or **USB** soft key* > and press **DISP/ENTER**.

* When a CF card and a USB flash memory (/USB1 option) are being used.

Directory name	Date / Time
/	
DATA0	05/01/12 20:59
DATA1	07/03/14 16:57
DATA2	07/03/15 15:08
DATA0_070222_132029	07/02/22 13:28
DATA0_070222_182607	07/02/23 08:53

Free space 440352 Kbytes
Delete ◀ ▶ Sort

Displaying a List of Files in a Directory and Checking the Free Space

Press the **arrow keys** to select a directory, and press **DISP/ENTER**. The files in the directory are displayed. The root directory is denoted by [/].

File name	Date / Time
000035_SAMPLE050112_210857H_.DAR	05/01/12 21:08
000197_SAMPLE050112_210852.DAD	05/01/12 21:08
000198_SAMPLE050112_210944.DAD	05/01/12 21:19
000199_SAMPLE050112_211944.DAD	05/01/12 21:29
000200_SAMPLE050112_212944.DAD	05/01/12 21:39
000201_SAMPLE050112_213944.DAD	05/01/12 21:49
000202_SAMPLE050112_214944.DAD	05/01/12 21:59
000036_SAMPLE050112_220000H_.DAR	05/01/13 03:12

Free space 440320 Kbytes
Delete ◀ ▶ Sort

Sorting Files and Directories (Release Number 2 or Later)

The files and directories can be sorted by the update date/time.

Each time you press the **Sort** soft key, the files and directories are sorted in order from the oldest or the latest update date/time. A mark indicating the sort order is displayed by Date/Time.

If the File Name Does Not Fit in the Display Space (Release Number 2 or Later)

Press the **▷** soft key once to shift the file name to the left by a character.

Press the **◁** soft key once to shift the file name to the right by a character.

Deleting a File

Press the **arrow keys** to select the file to be deleted, and press the **Delete** soft key. A confirmation window appears. Select **Yes**, and press **DISP/ENTER**.

The file is deleted.

This operation cannot be performed on DXs with the /AS1 advanced security option.

Deleting a Directory

First, delete all the files in the directory.

Select the directory you want to delete. The rest of the procedure is the same as deleting a file.

This operation cannot be performed on DXs with the /AS1 advanced security option.

Checking the Free Space

The free space on the storage medium is shown at the lower right of the screen.

- **Formatting the Storage Medium**

Formatting will remove the contents of the storage media.

This operation cannot be performed on DXs with the /AS1 advanced security option.

1. Carry out the procedure below to show the display.

Press **MENU** (to switch to setting mode), and select the **File** tab > **Format**. Press the **CF** or **USB** soft key*, and then press **DISP/ENTER**.

* When a CF card and a USB flash memory (/USB1 option) are being used.

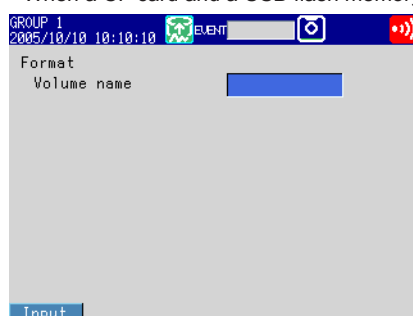

2. Enter the volume name and press **DISP/ENTER**. (Up to 11 characters, **A1**)
A confirmation window opens.
3. Select **Yes** and press **DISP/ENTER**.
The storage media is formatted.

Explanation

- **Format Type**

Size	Type
Storage medium smaller than or equal to 512 MB	FAT16
Storage medium greater than 512 MB	FAT32

6.8 Loading and Displaying the Measured Data in the Storage Medium

Load the display or event data file saved on the external storage medium and display the waveform. The loaded data is shown on the historical trend display.
For the operations on the historical trend display, see section 4.3.

Procedure

- **Loading a File**

1. Carry out the procedure below to show the display.

Press **MENU** (to switch to setting mode), and select the **File** tab > **Load display data** or **Load event data**. Press the **CF** or **USB** soft key*, and then press **DISP/ENTER**.

* When a CF card and a USB flash memory (/USB1 option) are being used.

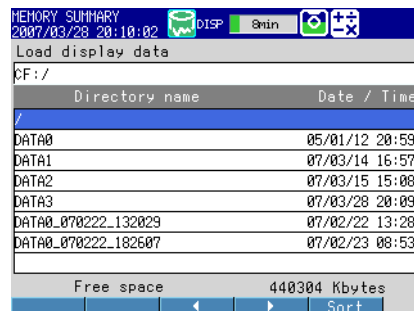

2. Press the **arrow keys** to select a directory, and press **DISP/ENTER**. The files in the directory are displayed. The root directory is denoted by [/].
3. Press the **arrow keys** to select a file, and press **DISP/ENTER**. The file is loaded, and the waveform is displayed in the historical trend.

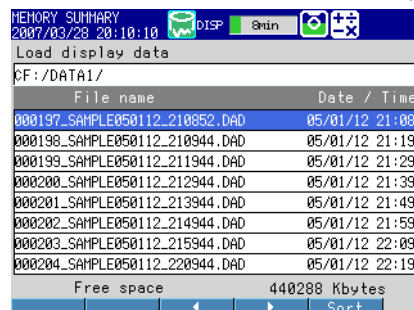

Note

- As shown in the table below, the display data and event data file name extensions change depending on whether or not the /AS1 advanced security option is installed.

Advanced Security	Display Data Files	Event Data Files
Not installed	.DAD	.DAE
Installed	.DSD	.DSE

- For details on how to use the Sort, >, and < soft keys, see section 6.7.

6.9 Saving/Loading the Setup Data

Save the setup data to the external storage medium or load the setup data from the external storage medium.

Procedure

• Saving the Setup Data

1. Carry out the procedure below to show the display.

Press **MENU** (to switch to setting mode), and select the **File** tab > **Save settings**.
Press the **CF** or **USB** soft key*, and then press **DISP/ENTER**.

* When a CF card and a USB flash memory (/USB1 option) are being used.

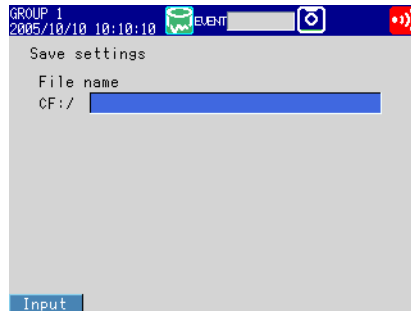

2. Set the file name. (Up to 32 characters, $[Aa\#1]$)
Symbols that can be used: #, %, (,), +, -, ., @, °, and _.
Strings that cannot be used: AUX, CON, PRN, NUL, CLOCK, COM1 to COM9, and LPT1 to LPT9.
To cancel the operation, press **ESC**.
3. Press **DISP/ENTER**.
The setup data is saved.

• Loading the Setup Data for the Setting Mode

1. Carry out the procedure below to show the display.

Press **MENU** (to switch to setting mode), and select the **File** tab > **Load settings**.
Press the **CF** or **USB** soft key*, and then press **DISP/ENTER**.

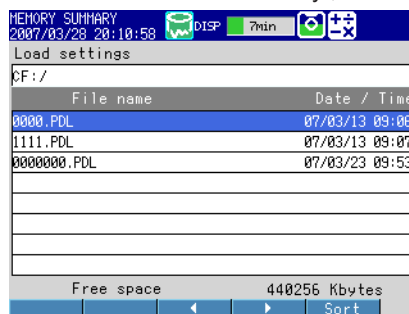

2. Use **DISP/ENTER** and **arrow keys** to select the setup file to be loaded.
* Setup data files are stored in the root directory [/].
To cancel the operation, press **ESC**.
3. Press **DISP/ENTER**.
The setup data is loaded.

Note

For details on how to use the Sort, \triangleright , and \triangleleft keys, see section 6.7.

6.9 Saving/Loading the Setup Data

- **Loading the Setup Data for the Setting Mode and Basic Setting Mode**

1. Carry out the procedure below to show the display.

On DXs without the /AS1 advanced security option

Press **MENU** (to switch to setting mode), hold down **FUNC** for 3 s (to switch to basic setting mode), and select the **File/Initialize** tab > **Load settings**. Press the **CF** or **USB** soft key*, and then press **DISP/ENTER**.

* When you are using a CF card and USB flash memory (/USB1 option).

On DXs with the /AS1 advanced security option

Press **MENU** (to switch to setting mode), hold down **FUNC** for 3 s (to switch to basic setting mode), and select the **File/Initialize** tab > **Load settings** > **All settings, Login info only**, or **Other settings**. Press the **CF** or **USB** soft key*, and then press **DISP/ENTER**.

* When you are using a CF card and USB flash memory (/USB1 option).

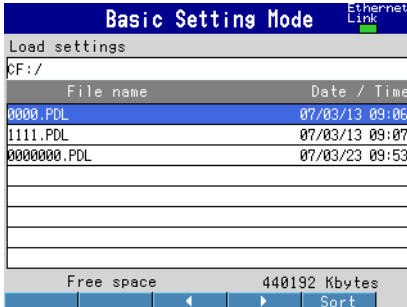

The screenshot shows the 'Basic Setting Mode' interface. At the top right, 'Ethernet Link' is indicated with a green status bar. The main title is 'Basic Setting Mode'. Below it, the screen displays 'Load settings' and 'CF:/' indicating the current directory. A table lists files with columns for 'File name' and 'Date / Time'. The files listed are 0000.PDL, 1111.PDL, and 0000000.PDL. At the bottom, it shows 'Free space 440192 Kbytes' and a 'Sort' button with left and right arrow keys.

File name	Date / Time
0000.PDL	07/03/13 09:06
1111.PDL	07/03/13 09:07
0000000.PDL	07/03/23 09:53

2. Use **DISP/ENTER** and **arrow keys** to select the setup file to be loaded.

* Setup data files are stored in the root directory [/].

To cancel the operation, press **ESC**.

3. Press **DISP/ENTER**.

The setup data is loaded.

Note

For details on how to use the Sort, **▷**, and **◁** keys, see section 6.7.

Explanation

- **Setup Data File**

- **On DXs without the /AS1 advanced security option**

- The setup data file extension is .PDL.
- The maximum setup data file size is approximately 250 KB.
- The following settings are also saved.
 - Current monitor display conditions
 - Default display registration data
 - Favorite key registration data

- **On DXs with the /AS1 advanced security option**

- The setup data file extension is .PEL.
- The maximum setup data file size is approximately 250 KB.
- The following settings are also saved.
 - Current monitor display conditions
 - Default display registration data
 - Favorite key registration data

- **Loading Setup Data**

- **On DXs without the /AS1 advanced security option**

- Only the setup data of the setting mode is loaded in the setting mode. However, settings that contradict the setup data of the basic setting mode are not loaded.
- The monitor display conditions, default display, and favorite keys are also loaded.
- If the contents of the loaded setup data is invalid, check the error log (see section 4.9).
- Operations through keys, communications, and remote control input are not executed while the setup data is being loaded.

- **On DXs with the /AS1 advanced security option**

- If the setup data is changed by loading new setup data, the original setup file is automatically saved to CF card. If no CF card is inserted, an error message appears and the operation cannot be completed.
- All settings, Login info only, and Other settings

The "Load settings" option	Description
All settings	The DX loads all setting mode and basic setting mode settings. However, the login password is not loaded. The password is set to the default password.
Login info only	The DX only loads the login settings. However, the login password is not loaded. The password is set to the default password.
Other settings	The DX loads all setting except for the login settings.

- In setting mode, only the setting mode settings are loaded. However, settings that contradict the basic setting mode settings are not loaded.
- In any case, the option to "Load settings" also loads monitor display conditions, the default display, and favorite keys.
- If the loaded setup data is not applied, check the error log (see section 4.9).

Note

- While loading the setup data, key operations, operations via communications, and operations via remote input are not available.
- While loading the setup data, actions of the Event Action function are disabled. Events occurring while loading the setup data are ignored.

6.10 Loading and Saving Report Templates (/M1 and /PM1 options; release numbers 4 and later)

This section explains the procedures for loading a report template (.xml extension) from an external storage medium and for saving a report template from the internal memory to an external storage medium.

Procedure

• Loading a Template File

1. Carry out the procedure below to show the display.

Press **MENU** (to switch to setting mode), and select the **File** tab > **Load template**. Press the **CF** or **USB** soft key*, and then press **DISP/ENTER**.

* When you are using a CF card and USB flash memory (/USB1 option).

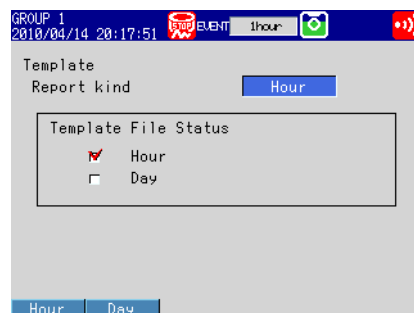

Under Template File Status, the check boxes of the template files that are stored in the internal memory are selected.

2. Press a **soft key** to select a report type, and press **DISP/ENTER**. The directories on the external storage medium appear. "/" is the root directory.
3. Use the **arrow keys** to select a directory, and press **DISP/ENTER**. The files in the directory will appear in a list.

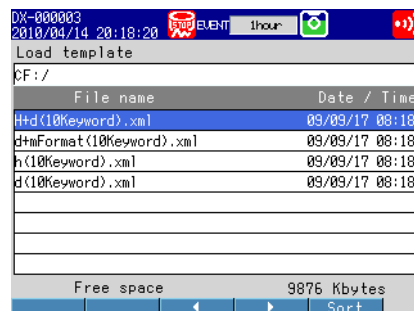

4. Use the **arrow keys** to select the file that you want to load, and press **DISP/ENTER**.

The report template file is loaded, and the screen from step 1 appears. The check boxes that are selected under Template File Status will match the file type that you loaded. If the DX fails to load the file, it will display an error message.

• **Saving a Template File**

1. Carry out the procedure below to show the display.
 Press **MENU** (to switch to setting mode), and select the **File** tab > **Save template**.
 Press the **CF** or **USB** soft key*, and then press **DISP/ENTER**.
 * When you are using a CF card and USB flash memory (/USB1 option).

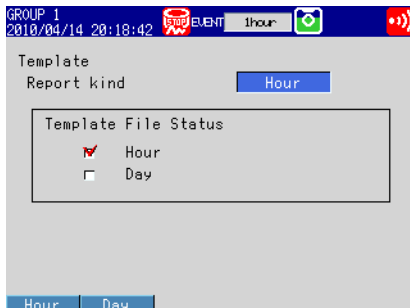

Under Template File Status, the check boxes of the template files that are stored in the internal memory are selected.

2. Press a **soft key** to select a report type, and press **DISP/ENTER**.
 The directories on the external storage medium appear. "/" is the root directory.
3. Use the **arrow keys** to select a directory, and press **DISP/ENTER**.

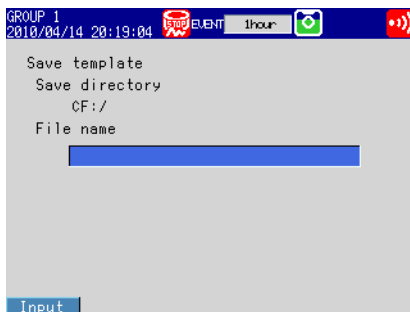

4. Enter the file name (up to 32 characters, $[Aa\#1]$).
 Symbols that can be used: #, %, (,), +, -, ., @, °, and _.
 Strings that cannot be used: AUX, CON, PRN, NUL, CLOCK, COM1 to COM9, and LPT1 to LPT9.
 To cancel the operation, press **ESC**.
5. Press **DISP/ENTER**.
 The report template file is saved.

Explanation

- **Report Template Files**

- The report template file name extension is .xml.
- The DX can only handle template files that are 400 KB or smaller.

- **Report Types and Templates Used**

Report Settings		Template Type
Report kind	File type	
Hour	Combine/Separate	The hourly report template
Daily	Combine/Separate	The daily report template
Hour+Day	Separate	The hourly report and daily report templates
	Combine	The hourly + daily report template
Day+Week	Separate	The daily report and weekly report templates
	Combine	The daily + weekly report template
Day+Month	Separate	The daily report and monthly report templates
	Combine	The daily + monthly report template

7.1 Setting the Event Action Function (Including the remote control function of the /R1 and /PM1 options and the USER key)

A specified action is carried out when an event occurs. This function is called event action. The remote control function (/R1 option) and the USER key are set by the event action.

For a description of the function, see section 1.6.

Setup Screen

- **Event and Action**

Press **MENU** (to switch to setting mode), and select the **Menu tab > Timer, Event action > Event action.**

Logic box number	2
Event	Remote
Remote number	1
Action	DisplayGroupChange
Group number	1

1 2 3 4 Next 1/10

- **Timer**

Press **MENU** (to switch to setting mode), and select the **Menu tab > Timer, Event action > Timer.**

- When set to relative time

Timer No.	1
Mode	Relative
Interval	01:00
Reset at Math Start	On

Input +1 -1

- When set to absolute time

Timer No.	1
Mode	Absolute
Interval	1h
Ref.time	0:00

Input +1 -1

- **Match Time**

Press **MENU** (to switch to setting mode), and select the **Menu tab > Timer, Event action > Match time timer.**

Timer number	1
Kind	Month
Day	1
Hour:Minute	00:00
Timer action	Repeat

Input +1 -1

Setup Items

- **Logic box number**

You can set up to 40.

- **Event action > Event**

The condition to execute the action.

Settings	Description
None	Not use.
Remote	Select the remote control input terminal number.
Relay	Select the alarm output relay number. During Edge operation, a change from deactivated to activated is an event.
Relay-Off ^{*2}	Select the alarm output relay number. During Edge operation, a change from activated to deactivated is an event. During Level operation, the action states that correspond to “activated” and “deactivated” are the opposite of when you select “Relay.”
Switch	Select the internal switch number. During Edge operation, a change from off to on is an event.
Switch-Off ^{*2}	Select the internal switch number. During Edge operation, a change from on to off is an event. During Level operation, the action states that correspond to “on” and “off” are the opposite of when you select “Switch.”
Timer	Select the timer number.
Matchtime	Select the match timer number.
Alarm	During Edge operation, a change from “no alarms are active” to “at least one alarm is active” is an event
.Alarm-Off ^{*2}	During Edge operation, a change from “at least one alarm is active” to “no alarms are active” is an event. During Level operation, the action states that correspond to “at least one alarm is active” and “no alarms are active” are the opposite of when you select “Alarm.”
UserKey	-
Edge ^{*1}	Select the event switch number (1 to 30). This function is available for release numbers 3 and later
Level ^{*1}	Select the event switch number (1 to 30). During Edge operation, a change from off to on is an event.
LevelOff ^{*2}	Select the event switch number (1 to 30). During Edge operation, a change from on to off is an event. During Level operation, the action states that correspond to “on” and “off” are the opposite of when you set the event to “Level.”

*1 Available for release numbers 3 and later.

*2 Available for release numbers 4 and later.

• **Event action > Action**

The action to be executed when an event occurs.

Settings	Description						
Memory	-						
Start	-						
Stop	-						
Trigger*	Can be specified when the DX is configured to record event data.						
AlarmACK	Cannot be specified when the event is set to Relay , Switch , or Alarm .						
Math	Can be specified on /M1 and /PM1 options.						
MathStrt	Start computation. Can be specified on /M1 and /PM1 options.						
MathStop	Stop computation. Can be specified on /M1 and /PM1 options.						
Math rst	Reset computation. Can be specified on /M1 and /PM1 options.						
SaveDisp	Can be specified when the DX is configured to record display data.						
SaveEvt	Can be specified when the DX is configured to record event data.						
Message	Set the message number to write the message and the destination. Set the message destination to all groups (All) or a group number.						
Snap	Snapshot						
Rate1/2	Can be specified when the function for switching between the trend interval and the secondary trend interval is enabled.						
M.sample	Manual sampling						
TimerRst	Cannot be specified when the event is set to Timer .						
Group	Specify the number of the group to be displayed.						
Flag	Can be specified on /M1 and /PM1 options.						
Time adj	Can be specified only when the event is set to Remote .						
PnILoad*	Can be specified only when the event is set to Remote .						
Comment	Specify the comment text block number to display. This function is available for release numbers 3 and later.						
Favorite	Choose which registered display to switch to. This function is available for release numbers 3 and later.						
	<table border="1"> <thead> <tr> <th>Setting</th> <th>Description</th> </tr> </thead> <tbody> <tr> <td>Key</td> <td>Performs the same operation as pressing the favorite key.</td> </tr> <tr> <td>Select>Favorite Screen No</td> <td>Displays the specified favorite screen.</td> </tr> </tbody> </table>	Setting	Description	Key	Performs the same operation as pressing the favorite key.	Select>Favorite Screen No	Displays the specified favorite screen.
Setting	Description						
Key	Performs the same operation as pressing the favorite key.						
Select>Favorite Screen No	Displays the specified favorite screen.						
	* If you configure the settings so that the Favorite action and the Group action occur at the same time, only the action whose event action number is largest will be executed.						
AlarmRst	This action can only be specified when using the double lock-in sequence of the alarm annunciator function (see section 3.12), and the event is Remote, UserKey, or Edge. This function is available for release numbers 3 and later.						

* This action is not available on DXs with the /AS1 advanced security option.

- **Timer**

Timer used by event action. Used also in the TLOG computation of the computation function.

* The timer cannot be changed while memory sampling or computation is in progress.

- **Timer No.**

Up to four timers (1 to 4) can be set.

When Using an Absolute Timer

- **Mode**

Select **Absolute**.

- **Interval**

Select the interval from the available settings between 1min to 24h.

- **Ref.time**

Set the time in the range of hour 0 to hour 23.

When Using a Relative Timer

- **Mode**

Select **Relative**.

- **Interval**

Set the interval in the range of 00:01 (1 min) to 24:00 (24 hours).

- **Reset at Math Start**

On: Resets the timer when computation is started. The resetting of the timer is not considered to be a timeout. Even if the timer is used as an event, the action is not executed.

- **Match Time Timer**

Set the time match condition used in event action.

* The condition cannot be changed while memory sampling or computation is in progress.

- **Timer number**

You can set up to four match time conditions (1 to 4).

- **Kind**

Setting	Description
Day	The condition is matched once a day.
Week	The condition is matched once a week.
Month	The condition is matched once a month.
Year	The condition is matched once a year. This function is available for release numbers 3 and later.

Set the items with check marks in the following table depending on the Kind setting.

Setting	Type			
	Day	Week	Month	Year
Month				✓
Day			✓	✓
Day of week		✓		
Hour:Minute	✓	✓	✓	✓

- **Month**

Specify the month.

- **Day**

Set the day.

- **Day of the week**

Set the day of the week.

- **Hour:Minute**

Set the time in the range of 00:00 to 23:59.

- **Timer action**

Settings	Description
Single	Executes the action once when the condition is met.
Repeat	Executes the action at every specified time.

Procedure

- **Resetting the Relative Timer**

1. In the operation mode, press **FUNC**.
The FUNC key menu appears.
2. Press the **Timer reset** soft key.
3. Press the **soft key** corresponding to timer you want to reset. Select **All** to reset all timers.
The relative timer is reset.

- **Operating Event Switches (Release number 3 or later)**

Operating Event Level Switches

You can operate an event level switch using:

- A custom display switch.
- A communication command.

Operating Event Edge Switches

You can operate an event edge switch using:

- The FUNC key (the procedure for operating the switch with the FUNC key is described below).
- A custom display push button.
- A communication command.

Operating the Event Edge Switch Using the FUNC Key

1. In operation mode, press **FUNC**.
The FUNC key menu appears.
2. Press the **Edge Switch** soft key.
3. Press the switch number **soft key**.
The switch will turn on briefly and then turn off again.

- **Displaying an Event Level Switch Status List (Release number 3 or later)**
Display the status of the event level switch. For the operating procedure, see section 4.5.

- **Resetting the Match Time Timer (Release number 3 or later)**
Operation ends when a match time timer whose timer action is set to single expires. To use such a match time timer again, you must reset it.
 1. In operation mode, press **FUNC**.
The FUNC key menu appears.
 2. Press the **Match T Reset** soft key.
* This soft key appears when a match timer whose timer action is set to single has expired.
 3. Press the **soft key** with the match time timer number of the timer that you want to reset.
The match time timer that you specify is reset.

Explanation

- **Resetting the Relative Timer**
Restarts the timer.
 - The resetting of the timer is considered to be a timeout. (If the timer is used as an event, the action is executed.)
 - If the timer is used in TLOG computation on the /M1 or /PM1 math option and TLOG computed value reset at each interval is specified, the computed result is reset.

- **Resetting the Match Time Timer (Release number 3 or later)**
This operation resets an expired match time timer so that it can operate again.
 - The resetting of a match time timer does not count as a timer expiration (and it will not count as an event action event).
 - This operation can be used with match time timers whose timer action is set to single.
 - If the timer is used in TLOG computation on the /M1 or /PM1 math option and TLOG computed value reset at each interval is specified, the computed result is reset.

7.2 Setup Examples of Event Action

Example 1: Starting/Stopping the Memory Sampling through Remote Control (/R1 Option)

Starts/Stops the memory sampling when a signal is applied to remote control input terminal 2. Use logic box number 1.

- **Setup Screen and Setup Items**

Press **MENU** (to switch to setting mode), and select the **Menu** tab > **Timer, Event action** > **Event action**.

Logic box number	1
Event	Remote
Remote number	2
Action	MemoryStart/Stop

<Operation>

If the input to the remote control input terminal 2 is turned ON when memory sampling is stopped, memory sampling starts. If the remote control input is turned OFF when memory sampling is in progress, memory sampling stops.

Example 2: Writing a Message When an Alarm Occurs

Write the message "Channel 1 Alarm" to group 1 when an alarm occurs on channel 1. Use logic box number 2.

- **Setup Screen and Setup Items**

Press **MENU** (to switch to setting mode), and select the **Menu** tab > **Timer, Event action** > **Event action**.

Logic box number	2
Event	Switch
Switch No.	S03
Action	Message
Message No.	4
Write to	Select
Group number	1

<Other Settings>

- Set an alarm to channel 1 and output to internal switch 3.
- Register "Channel 1 alarm" in message number 4.

For the procedure to set the alarm, see section 3.7.

For the procedure to set the message, see section 5.4.

Example 3: Saving the Data Every Day at Hour 17

Save the recorded data to the CF card every day at hour 17. Use logic box number 3. Use match time condition 1.

- **Setup Screen and Setup Items**

Logic box number 3

Press **MENU** (to switch to setting mode), and select the **Menu** tab > **Timer, Event action** > **Event action**.

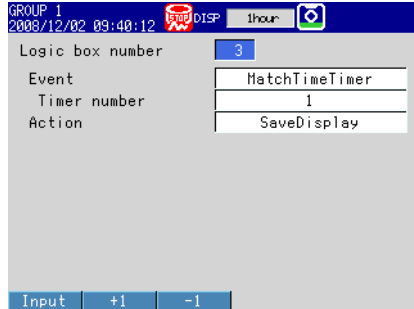

Match Time Condition

Press **MENU** (to switch to setting mode), and select the **Menu** tab > **Timer, Event action** > **Match time timer**.

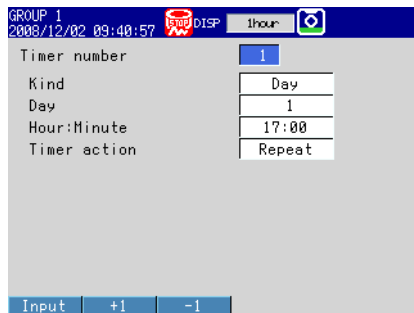

<Other Settings>

Set the display data to be saved automatically. Set the file save interval to **1day** or longer. If a file save interval shorter than **1day** is specified, the data is also saved at the file save interval.

For the procedure to set the recording conditions of the display data, see section 6.1.

Example 4: Releasing the Alarm Output Using the USER Key (Alarm Acknowledge Operation)

Release the activated alarm output by pressing the USER key. Use logic box number 4.

- **Setup Screen and Setup Items**

Press **MENU** (to switch to setting mode), and select the **Menu** tab > **Timer, Event action** > **Event action**.

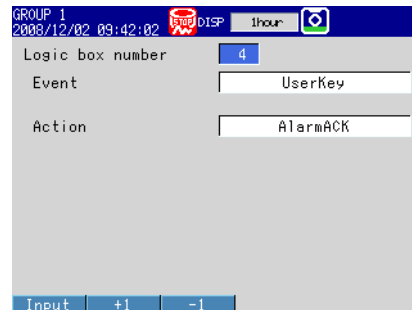

<Operation>

Press the USER key to release the activated alarm indication and relay output.

<Related Settings>

Set the alarm indication and alarm output relay operation to **Hold**.

For the procedure to set the alarm indication operation and alarm output relay operation, see section 3.5.

7.3 Changing the Response to Remote Contact Input Opening and Closing (/R1 and /PM1 options; release number 3 or later)

Set the remote contact input operation.

Setup Screen

Press **MENU** (to switch to setting mode), hold down **FUNC** for 3 s (to switch to basic setting mode), and select the **Environment** tab > **Remote**.

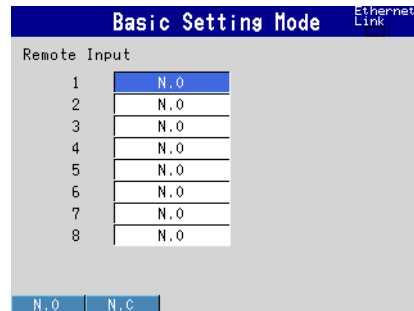

Setup Items

- **Remote Input > 1 to 8**

Specify an operation for each remote control terminal. Five remote control terminals can be used for pulse input (/PM1 option).

Setting	Description
N.O	The remote signal rises when the contact input switches from open to closed, and it falls when the contact input switches from closed to open.
N.C	The remote signal rises when the contact input switches from closed to open, and it falls when the contact input switches from open to closed.

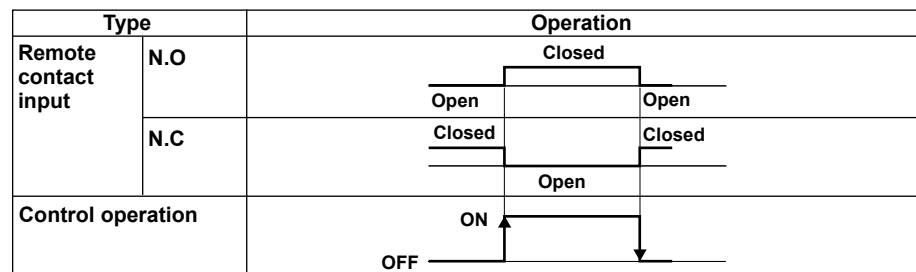

Note

On models with the pulse input option (/PM1), the remote control input terminals can be used for pulse input. When pulses are counted, the number of rising pulse edges is counted, regardless of the Remote Input setting.

8.1 Disabling the Key Operation (Key Lock Function)

Disable the key operation.

For a description of the function, see section 1.7.

This operation cannot be performed on DXs with the /AS1 advanced security option.

Setup Screen

- Selecting the Key Lock Function**
 Press **MENU** (to switch to setting mode), hold down **FUNC** for 3 s (to switch to basic setting mode), and select the **Environment** tab > **Security, Media save**.

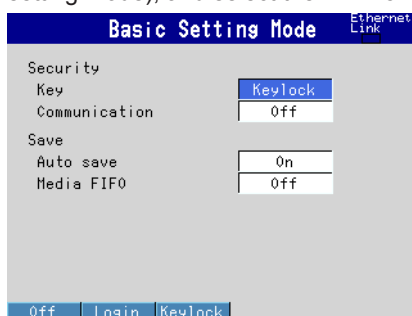

- Key Operation to Be Disabled**
 Press **MENU** (to switch to setting mode), hold down **FUNC** for 3 s (to switch to basic setting mode), and select the **Menu** tab > **Keylock** > **Key Action, Media or Action of Function**.

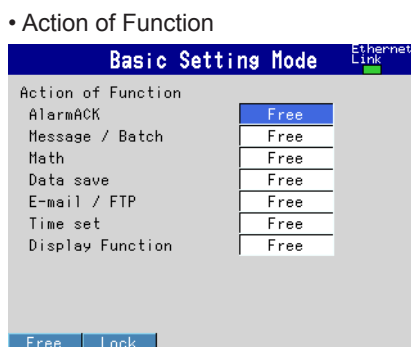
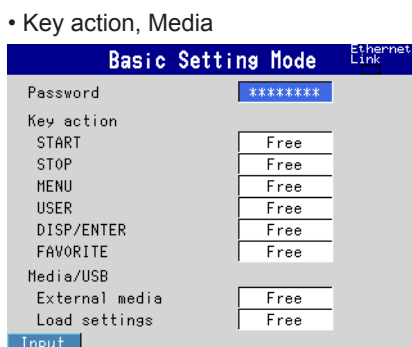

Setup Items

- Security > Key**
 Select **Keylock**.

Settings	Description
Keylock	Enables the key lock function. The Keylock item is displayed in the basic setting mode menu.
Login	Enables the login function. See section 8.2.

- Keylock > Password**
 The password used to release the key lock. (Up to 8 characters, [Aa#1])
 The password is displayed as "*****" (release number 3 or later).

8.1 Disabling the Key Operation (Key Lock Function)

- **Key action, Media/USB or Action of Function**

Select whether to lock each item.

Settings	Description
Free	Key lock not applied.
Lock	Disables the operation.

Procedure

- **Locking the Keys**

1. In the operation mode, press **FUNC**.
The FUNC key menu appears.
2. Press the **Keylock** soft key.
The key lock is activated. The key lock icon appears in the status display section.

- **Releasing the Key Lock**

1. In the operation mode, press **FUNC**.
The FUNC key menu appears.
2. Press the **Keylock** soft key.
A window appears for you to enter the password.

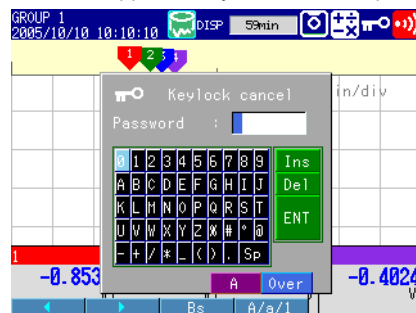

3. Enter the password and press **DISP/ENTER**.
The key lock is released. The key lock icon in the status display section disappears.
* The password that you entered is displayed as "*****."

8.2 Enabling Only Registered Users to Operate the DX (Login Function)

Only registered users can operate the DX.

For a description of the function, see section 1.7.

For information about using this function on a DX with the /AS1 advanced security option, see the *Advanced Security Function (/AS1) User's Manual, IM04L41B01-05EN*.

Setup Screen

- **Login Function**

Press **MENU** (to switch to setting mode), hold down **FUNC** for 3 s (to switch to basic setting mode), and select the **Environment** tab > **Security, Media save**.

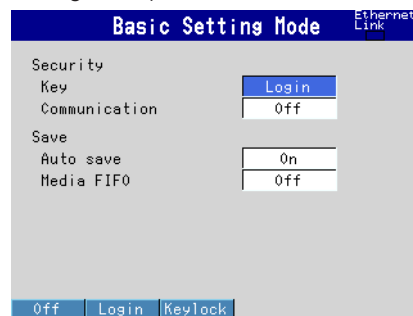

- **Logout Method**

Press **MENU** (to switch to setting mode), hold down **FUNC** for 3 s (to switch to basic setting mode), and select the **Menu** tab > **Login** > **Basic settings**.

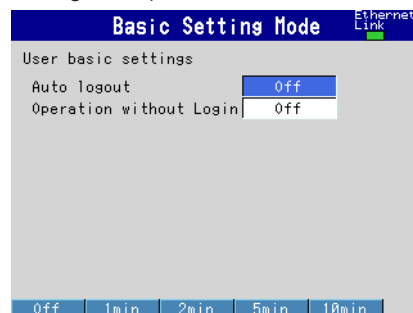

- **Registering Administrators**

Press **MENU** (to switch to setting mode), hold down **FUNC** for 3 s (to switch to basic setting mode), and select the **Menu** tab > **Login** > **Admin settings**.

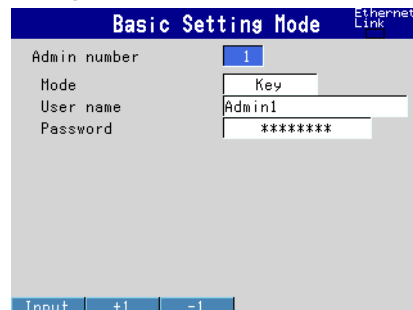

8.2 Enabling Only Registered Users to Operate the DX (Login Function)

- **Registering Users**

Press **MENU** (to switch to setting mode), hold down **FUNC** for 3 s (to switch to basic setting mode), and select the **Menu** tab > **Login** > **User settings**.

Basic Setting Mode Ethernet Link

User number: 1

Mode: Key

User name: User1

Password: *****

Authority of user: Off

Input +1 -1

- **User Privileges**

Press **MENU** (to switch to setting mode), hold down **FUNC** for 3 s (to switch to basic setting mode), and select the **Menu** tab > **Login** > **Authority of user** > **Key Action**, **Media** or **Action of Function**.

Basic Setting Mode Ethernet Link

Authority of user: 1

Key action

START: Free

STOP: Free

MENU: Free

USER: Free

DISP/ENTER: Free

FAVORITE: Free

Media/USB

External media: Free

Load settings: Free

Input +1 -1

Basic Setting Mode Ethernet Link

Authority of user: 1

Action of Function

AlarmACK: Free

Message / Batch: Free

Math: Free

Data save: Free

E-mail / FTP: Free

Time set: Free

Display Function: Free

1 2 3 4 Next 1/3

Setup Items

The login function can be set separately for login through keys and login through communications.

- **Security > Key**

Select **Login**.

Settings	Description
Login	Enables only registered users to operate the DX using keys. The Login item is displayed in the basic setting mode menu.
Keylock	Enables the key lock function. See section 8.1.
Off	Disables the security functions.

- **Security > Communication**

Settings	Description
Login	Enables only registered users to operate the DX via communications. The Login item is displayed in the basic setting mode menu.
Off	Disables the security functions.

- **User basic settings > Auto logout**

Settings	Description
Off	Does not log out until the logout operation is executed.
1min to 10min	Automatically logs out when there is no key operation for a specified time.

8.2 Enabling Only Registered Users to Operate the DX (Login Function)

- **User basic settings > Operation without login**

Sets the operation that the user can carry out when logged out.

Settings	Description
Off	Only login operation is available.
Display	Allows the user to switch the operation screen in addition to the login operation.

- **Admin number**

Up to five administrators can be registered. Be sure to register at least one administrator. At least one administrator must be registered to use the login function.

- **Admin settings > Mode**

The available settings vary depending on the **Security** setting.

Settings	Description
Off	Not register.
Key	Log into the DX using keys.
Comm	Log into the DX via communications.
Web	Log into the operator page and monitor page of the DX using a Web browser.
Key+Comm	Log into the DX using keys and via communications.

- **Admin settings > User name**

Set the user name. (Up to 20 characters, [Aa#1])

- You cannot register user names that are already registered.
- You cannot register “quit” or a user name containing all spaces.

- **Admin settings > Password**

Set the password. (Release numbers 3 and later: up to 8 characters. Release numbers 4 and later: up to 20 characters. [Aa#1])

Unregistered password is displayed as “????????”. An entered password is displayed as “*****”.

- You cannot register “quit” or a password containing all spaces.

- **User number**

Up to 30 users can be registered.

- **User settings > Mode**

The available settings vary depending on the **Security** setting.

Settings	Description
Off	Not register.
Key	Log into the DX using keys.
Comm	Log into the DX via communications.
Web	Log into the monitor page of the DX using a Web browser.
Key+Comm	Log into the DX using keys and via communications.

- **User settings > User name, Password**

See the explanation for the administrator user name and password.

- **Authority of user**

Settings	Description
Off	No limitations on the operation.
1 to 10	Registration number of the operation limitation.

- **Authority of user > Key action, Media/USB, Action of Function**

Select the “authority of user” preset number from 1 to 10.

See section 8.1.

8.3 Logging in and Logging Out

This section explains the procedure to log into the DX using keys. For the procedure to log into the DX via communications, see the *Communication Interface User's Manual, IM04L41B01-17E*.

For information about using this function on a DX with the /AS1 advanced security option, see the *Advanced Security Function (/AS1) User's Manual, IM04L41B01-05EN*.

Procedure

• Logging In

1. In the operation mode, press **FUNC**.

A list of registered user names appears.

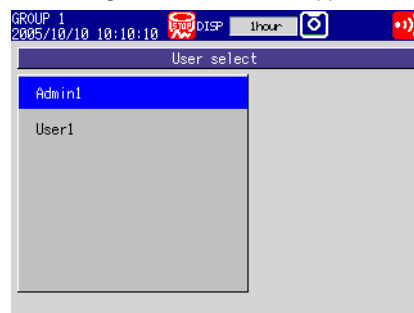

2. Press the **arrow keys** to select a user name, and press **DISP/ENTER**.

A window appears for you to enter the password.

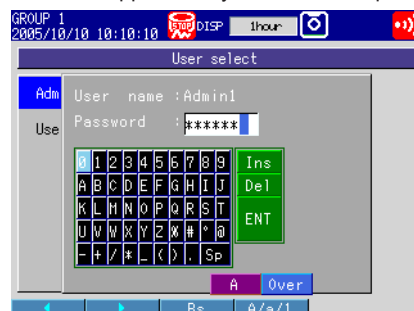

3. Enter the password* and press **DISP/ENTER**.

The DX is ready to be operated using keys. The name of the user that is logged in is displayed in the status display section.

* The password that you enter is displayed as "*****."

• Logging Out

Using Keys

1. In the operation mode, press **FUNC**.

The FUNC key menu appears.

2. Press the **Logout** soft key.

You are logged out from the DX. The user name in the status indication section disappears.

Auto Logout

If auto logout is enabled, you are automatically logged out if there is no key operation for a specified time.

- **Changing the Password Using Keys**

- 1.** In the operation mode, press **FUNC**.
The FUNC key menu appears.
- 2.** Press the **Password change** soft key.
A window appears for you to enter the current password.
- 3.** Enter the current password, select **ENT**, and press **DISP/ENTER**.
A window appears for you to enter the new password.
- 4.** Enter the new password, select **ENT**, and press **DISP/ENTER**.
A window appears for you to enter the new password again.
- 5.** Enter the new password, select **ENT**, and press **DISP/ENTER**.
The window closes, and the new password is activated.

9.1 Setting the Expression, Measurement Range, Alarm, Tag, and Data Storage on Computation Channels

This section explains how to set a computation channel's expression, measurement range, tag, alarm, and recording On/Off. You cannot set expressions or constants while memory sampling or computation is in progress. For a description of the function, see section 1.8.

Setup Screen

- Expression and Alarm**

Press **MENU** (to switch to setting mode), and select the **Menu** tab > **Math channel** > **Expression, Alarm.**

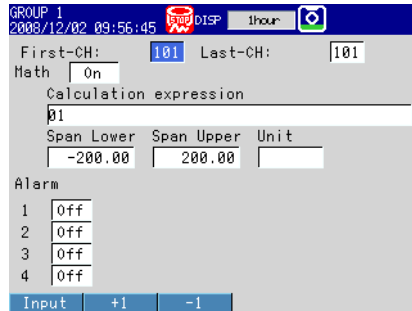

- Constants Used in Expressions**

Press **MENU** (to switch to setting mode), and select the **Menu** tab > **Math channel** > **Constant.**

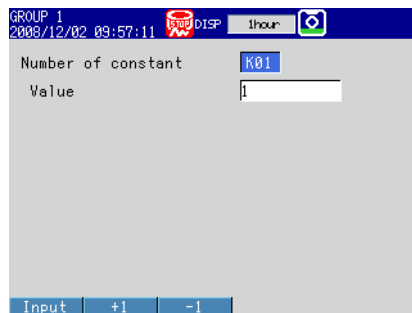

- Tag, Memory Sampling On/Off, and Alarm Delay Time of Computation Channels**

Press **MENU** (to switch to setting mode), and select the **Menu** tab > **Math channel** > **Tag, Memory, Delay.**



9.1 Setting the Expression, Measurement Range, Alarm, Tag, and Data Storage on Computation Channels

- **Conditions of TLOG Computation and Rolling Average**

Press **MENU** (to switch to setting mode), and select the **Menu** tab > **Math channel** > **TLOG, Rolling average**.

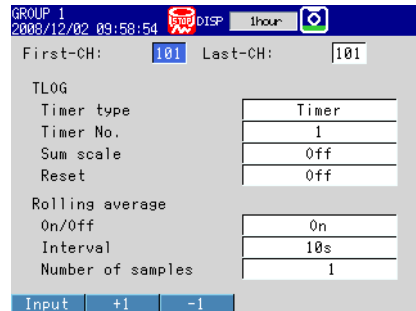

- **Display for Computation Errors and Handling of Overflow Data in Statistical Computation**

Press **MENU** (to switch to setting mode), hold down **FUNC** for 3 s (to switch to basic setting mode), and select the **Environment** tab > **Math**.

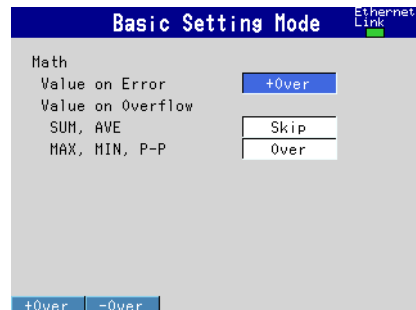

Setup Items

- **First-CH/Last-CH**

Set the target channels.

- **Expression/Span**

- **Math On/Off**

Select **On** for channels to be used.

- **Calculation expression**

Enter the expression using up to 120 characters.

Pressing the **Input** soft key displays a window used to enter the expression.

Press the **M1/M2** soft key to switch between a screen used to enter values

and characters and a screen used to enter operators and functions. Use

soft keys, arrow keys, and DISP/ENTER to enter an expression.

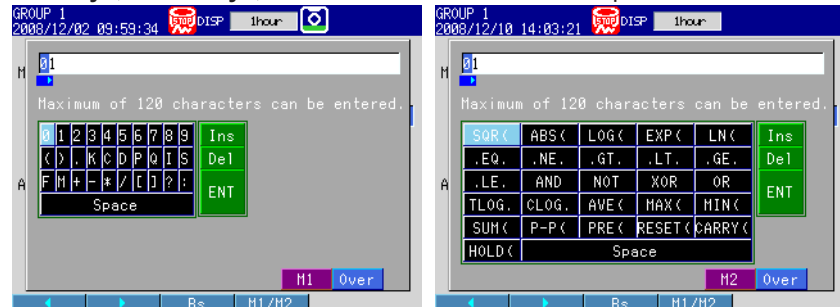

For details on how to write expressions, see section 9.2.

Note

You cannot use both the USB keyboard (/USB1 option) and the DX keys to enter the equation. If you press a DX soft key, for example, while you are entering an equation from the USB keyboard, the entered equation is cleared.

9.1 Setting the Expression, Measurement Range, Alarm, Tag, and Data Storage on Computation Channels

- **Span_L, Span_U**
Set the measurement range.
Selectable range of values: -9999999 to 99999999
Selectable decimal places: X.XXXX, XX.XXX, XXX.XX, XXXX.X
- **Unit**
Set the unit of the computed value (Up to 6 characters, [Aa#1](#)).
- **Alarm**
The available alarm types are high limit alarm, low limit alarm, delay high limit alarm, and delay low limit alarm.
The range of alarm values is as follows:

Type	Value
H, L, T, t	Within -9999999 to 99999999 excluding the decimal point
- For details on setting alarms, see section 3.7.
- * If the Math On/Off or calculation expression is changed, the alarms for that channel are turned **Off**.
- **Alarm delay > Time**
Set the alarm delay time using an integer in the range of 1 to 3600 s.
- **Tag > Comment**
Sets the tag comment. On a DX with a release number of 3 or later, you can enter up to 32 characters. On a DX with a release number of 2 or earlier, you can enter up to 16 characters. The characters that can be entered are: [Aa#1](#).
- **Tag > No. (Release number 3 or later)**
This setting only appears when you have enabled the use of tag numbers.
Sets the tag number. (Up to 16 characters: [Aa#1](#))
- **Constant**
 - **Number of constant**
Select the constant (K01 to K60) to set.
 - **Value**
The selectable range is as follows:
-9.9999E+29 to -1.0000E-30, 0, 1.0000E-30 to 9.9999E+29
The number of significant digits of a constant is five. When specifying the constant using exponential notation, set the mantissa less than or equal to 5 digits and the exponent less than or equal to 2 digits.
- **TLOG**
 - **Timer type**
You can set the timer type to **Timer** or **Match T** (match time timer).
 - **Timer No.**
Select the timer number to use.
For details on setting the timer, see section 7.1.
For match time timer setting instructions, see section 7.1.
 - **Sum scale**
Set the sum scale to **/s** to **/h** to match the unit of the measured value.
Example: If the unit of the measured value is "m³/min," select **/min**.
Off: Sums as-is the measured data per scan interval.
 - **Reset**
To reset the TLOG computed value at each interval, select **On**.

9.1 Setting the Expression, Measurement Range, Alarm, Tag, and Data Storage on Computation Channels

- **Rolling average**
 - **On/Off**

To take the rolling average of the measured results, select **On**.
 - **Interval**

Select the sampling interval when taking the rolling average from the following: The sampling interval takes on a value that is an integer multiple of the scan interval. For example, if the sampling interval is set to 5 s when the scan interval is 2 s, the actual sampling interval is 6 s.
 - **Number of samples**

Set the number of samples for the rolling average using an integer between 1 and 1500.

The rolling average time is equal to the sampling interval × the number of samples.

Note

- If the number of data points to be averaged has not reached the specified number of samples immediately after computation is started, the average of the available data is calculated.
- Computation error data is excluded from the rolling average computation.
- If the computed data exceeds the upper or lower limit, the data is clipped at the upper or lower limit, and the rolling average is computed. The upper and lower limit is “±100000000” excluding the decimal point. The decimal place is the same as that of the span lower limit.

- **Memory sample > On/Off**

Select **On** to record the computed data of the target channels.

Math

- **Value on Error**

Specify whether to set the display for a computation error to **+Over** or **-Over**.
- **Value on Overflow > SUM, AVE**

Specify how to handle overflow data when it is detected in the SUM or AVE computation of TLOG or CLOG. This setting is also applied to report generation.

Settings	Description
Error	Sets the computed result to computation error.
Skip	Discards the overflow data and continues the computation.
Limit	Uses a limit value in place of the overflow data and continues the computation.

- **Value on Overflow > MAX, MIN, P-P**

Specify how to handle overflow data when it is detected in the MAX, MIN, or P-P computation of TLOG or CLOG. This setting is also applied to report generation.

Settings	Description
Over	Uses the overflow data as-is.
Skip	Discards the overflow data and continues the computation.

9.2 Writing Expressions

This section explains the meaning and how to write expressions.

Common Items

Follow the rules below when writing expressions.

- Use up to 120 characters to write expressions.
- The precedence of computing terms can be specified using parentheses.
- Specify the channels in the expression using channel numbers.
Example: 1, 12, and 101
- The one-digit number of constants (K), communication input data (C), remote input terminal status (D), pulse input (P, Q), internal switch (S), alarm output relay status (I), flag (F), and recording (memory sampling) status (M) in the expression can be denoted as in "01" and "1."
Example: K01, K1, C01, C1, D01, D1, P01, P1, Q01, Q1, S01, S1, I01, I1, F01, and F1.
- The data of the previous scan is used in the computation for its own channel number and channel numbers greater than its own channel number in the expression.
- Special computation (HOLD, RESET, and CARRY) and conditional expressions are written at the beginning of the expression.

Order of Precedence in Computations

The order of precedence of computation in expressions is as follows:

Type	Computing Element
Function	(high order of precedence) ABS(), SQR(), LOG(), LN(), EXP(), TLOG.MAX(), TLOG.MIN(), TLOG.AVE(), TLOG.SUM(), TLOG.P-P(), CLOG.MAX(), CLOG.MIN(), CLOG.AVE(), CLOG.SUM(), CLOG.P-P()
Special computation and conditional expression	PRE, HOLD, RESET, CARRY, [a?b:c]
Power	**
Logical negation	NOT
Multiplication and division	*, /
Addition and subtraction	+, -
Greater than and less than	.GT., .LT., GE., LE.
Equal and not equal	.EQ., .NE.
Logical product	AND
Logical sum and exclusive logical sum	OR, XOR
	(low order of precedence)

Limitations

The following limitations exist in writing expressions.

Type	Limitations
TLOG computation	A computing element cannot be written inside the parentheses. Only one TLOG computation can be specified in a single expression.
CLOG computation	Number of channels that can be written in the parentheses is 30 channels or less. A computing element cannot be written inside the parentheses. Only one CLOG computation can be specified in a single expression.
PRE	A computing element cannot be written inside the parentheses.
HOLD(a):b	Can only be written at the beginning of an expression. Only one HOLD computation can be specified in a single expression.
RESET(a):b	Can only be written at the beginning of an expression. Only one RESET computation can be specified in a single expression.
CARRY(a):b	Can only be written at the beginning of an expression. Only one CARRY computation can be specified in a single expression. Only TLOG.SUM can be written in "b."
Conditional equation [a?b:c]	RESET, CARRY, or HOLD cannot be written to "a," "b," or "c." Other computing elements cannot be combined (example: [a?b:c]+001). However, conditional equations can be specified for a, b, and c.

Four Arithmetic Operation

Expression Example

- Addition 001+002
(Determines the sum of the measured values of channel 1 and channel 2.)
- Subtraction 001-002
(Determines the difference of the measured values of channel 1 and channel 2.)
- Multiplication 001*K03
(Multiplies constant K03 to the measured value of channel 1.)
- Division 001/K02
(Divides the measured value of channel 1 by constant K02.)

Power and Other Computations

Expression Example

- Power 001**002
(Determines the measured value of channel 1 to the power of the measured value of channel 2.)
- Square root SQR(002)
(Determines the square root of the measured value of channel 2.)
- Absolute value ABS(002)
(Determines the absolute value of the measured value of channel 2.)
- Common logarithm LOG(001)
(Determines the common logarithm (\log_{10}) of the measured value of channel 1.)
- Natural logarithm LN(001)
(Determines the natural logarithm of the measured value of channel 1.)
- Exponent EXP(001)
(Determines e to the power of the measured value of channel 1.)

Relational Computation

Expression Example

002.LT.003

If the measured value of channel 2 is less than the measured value of channel 3, the computed result is "1." Otherwise, the result is "0."

002.GT.003

If the measured value of channel 2 is greater than the measured value of channel 3, the computed result is "1." Otherwise, the result is "0."

002.EQ.003

If the measured value of channel 2 is equal to the measured value of channel 3, the computed result is "1." Otherwise, the result is "0."

002.NE.003

If the measured value of channel 2 is not equal to the measured value of channel 3, the computed result is "1." Otherwise, the result is "0."

002.GE.003

If the measured value of channel 2 is greater than or equal to the measured value of channel 3, the computed result is "1." Otherwise, the result is "0."

002.LE.003

If the measured value of channel 2 is less than or equal to the measured value of channel 3, the computed result is "1." Otherwise, the result is "0."

Logical Computation

Checks whether the two data values, e1 and e2 (e1 only for NOT), are zeroes or non-zeroes, and computes according to the conditions.

AND

Logical product

(Syntax) e1ANDe2

(Condition) If the two data values e1 and e2 are both non-zeroes, the computed result is "1." Otherwise, it is "0."

(Explanation)

e1 = 0, e2 = 0	→	e1ANDe2 = 0
e1 ≠ 0, e2 = 0	→	e1ANDe2 = 0
e1 = 0, e2 ≠ 0	→	e1ANDe2 = 0
e1 ≠ 0, e2 ≠ 0	→	e1ANDe2 = 1

OR

Logical sum

(Syntax) e1ORe2

(Condition) If the two data values e1 and e2 are both zeroes, the computed result is "0." Otherwise, it is "1."

(Explanation)

e1 = 0, e2 = 0	→	e1ORe2 = 0
e1 ≠ 0, e2 = 0	→	e1ORe2 = 1
e1 = 0, e2 ≠ 0	→	e1ORe2 = 1
e1 ≠ 0, e2 ≠ 0	→	e1ORe2 = 1

XOR

Exclusive OR

(Syntax) e1XORe2

(Condition) If the two data values e1 and e2 are zero and non-zero or non-zero and zero, the computed result is "1." Otherwise, it is "0."

(Explanation)

e1 = 0, e2 = 0	→	e1XORe2 = 0
e1 ≠ 0, e2 = 0	→	e1XORe2 = 1
e1 = 0, e2 ≠ 0	→	e1XORe2 = 1
e1 ≠ 0, e2 ≠ 0	→	e1XORe2 = 0

NOT

Logical negation

(Syntax) NOTe1

(Condition) The result is the inverse of the status of data e1 (zero or non-zero).

(Explanation)

e1 = 0	→	NOTe1 = 1
e1 ≠ 0	→	NOTe1 = 0

Expression Example

01-02OR03.GT.04

Determines the OR of the computed results of "01-02" and "03.GT.04".

TLOG Computation

In the explanation below, an expression containing a computing element in e1, an internal switch (S), a relay (I), or flag (F) cannot be written. In addition, only one TLOG computation can be specified in a single computing equation.

TLOG.MAX()

Maximum value

(Syntax) TLOG.MAX(e1)

(Condition) Determines the maximum value of channel e1.

TLOG.MIN()

Minimum value

(Syntax) TLOG.MIN(e1)

(Condition) Determines the minimum value of channel e1.

TLOG.AVE()

Average value

(Syntax) TLOG.AVE(e1)

(Condition) Determines the average value of channel e1.

TLOG.SUM()

Sum value

(Syntax) TLOG.SUM(e1)

(Condition) Determines the sum of channel e1.

TLOG.P-P()

Maximum - minimum value

(Syntax) TLOG.P-P(e1)

(Condition) Determines the maximum - minimum value of channel e1.

Expression Example

TLOG.MAX(01)+K01*SQR(02)

Examples of Equations That Are Not Allowed

TLOG.AVE(01)+TLOG.AVE(02)

Reason: TLOG appears twice in one equation.

TLOG.AVE(ABS(01))

Reason: A computing element is used inside the parentheses.

CLOG Computation

Only data of measurement channels and computation channels can be used in the CLOG computation. Up to 30 channels can be written in the parentheses.

In the explanation below, an expression containing a computing element cannot be written to e1, etc. In addition, only one CLOG computation can be specified in a single computing equation.

CLOG.SUM()

Sum value

(Syntax) CLOG.SUM(e1.e2.e4-e6)

(Condition) Determines the sum of the data of channels e1, e2, e4, e5, and e6 that are measured at the same time.

CLOG.MAX()

Maximum value

(Syntax) CLOG.MAX(e1.e2.e4-e6)

(Condition) Determines the maximum value among the data of channels e1, e2, e4, e5, and e6 that are measured at the same time.

CLOG.MIN()

Minimum value

(Syntax) CLOG.MIN(e1.e2.e5.e7)

(Condition) Determines the minimum value among the data of channels e1, e2, e5, and e7 that are measured at the same time.

CLOG.AVE()

Average value

(Syntax) CLOG.AVE(e1-e6)

(Condition) Determines the average value among the data of channels e1 to e6 that are measured at the same time.

CLOG.P-P()

Maximum - minimum value

(Syntax) CLOG.P-P(e1.e2.e5.e7)

(Condition) Determines the difference between the maximum and minimum values among the data of channels e1, e2, e5, and e7 that are measured at the same time.

Expression Example

CLOG.MAX(001.002.104-106)+K01*SQR(002)

Examples of Equations That Are Not Allowed

CLOG.AVE(001.003.005)+CLOG.AVE(002.004.006)

Reason: CLOG appears twice in one equation.

CLOG.AVE(001.ABS(001))

Reason: A computing element is used inside the parentheses.

Special Computation

PRE()

(Syntax) PRE(e1)
 (Condition) Determines the previous value of e1.

HOLD(a):b

(Syntax) HOLD(a):b
 (Condition) When a is zero, b is carried out to derive the computed value. Otherwise, the previous computed value is held.

RESET(a):b

(Syntax) RESET(a):b
 (Condition) When a is zero, b is carried out to derive the computed value. Otherwise, the previous computed value of b is reset, and b is carried out to derive the computed value.

CARRY(a):b

(Syntax) CARRY(a):b
 (Condition) Only TLOG.SUM can be specified for b. If the computed value X of b is less than a, the computed result is X. If X is greater than or equal to a, the computed result is the excess (X – a).
 (Description) When a value such as the flow rate is summed and the threshold value is reached or exceeded, the sum value is reset while carrying over the amount that exceeded the threshold value.

Expression Example

Expression that sums the values of channel 1 and resets the value when it reaches or exceeds 10000
 K01 = 10000
 CARRY(K01):TLOG.SUM(001)

Examples of Equations That Are Not Allowed

002+HOLD(K01):TLOS.SUM(001)
 Reason: HOLD is not at the beginning of the expression.

RESET(101.GT.K01):TLOG.SUM(001)+RESET(101.GT.K01):002
 Reason: RESET appears twice in one equation.

Conditional Expression

[a?b:c]

(Syntax) [001.GT.K01?002:003]
 (Condition) If the measured value of channel 1 is greater than constant K01, the computed result is the measured value of channel 2. Otherwise, the computed result is the measured value of channel 3.

Examples of Equations That Are Not Allowed

[001.GT.K01?002:003]*K02
 Reason: Used in combination with another computing element.

Nested Conditional Expressions

A conditional expression can be written to Expression₁, Expression₂, and Expression₃ in the equation [Expression₁?Expression₂:Expression₃]. For example, the following expression is allowed: [Equation₁?[Equation₂₋₁?Equation₂₋₂:Equation₂₋₃]:[Equation₃₋₁?Equation₃₋₂:Equation₃₋₃]]
 Expressions can be nested as long as the number of characters of the expression does not exceed 120 characters.

9.3 Displaying the Computation Channels

Computation channels can be assigned to groups and displayed in a similar manner to measurement channels.

For a description of the function, see section 1.8.

Setup Screen

- **Color**

Press **MENU** (to switch to setting mode), and select the **Menu** tab > **Math channel** > **Color**.

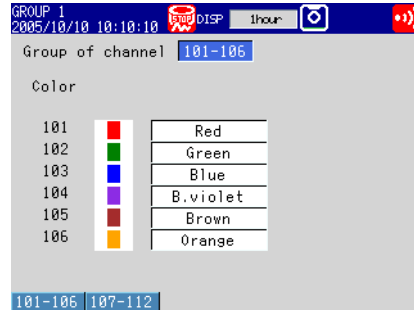

- **Zone Display and Scale Display**

Press **MENU** (to switch to setting mode), and select the **Menu** tab > **Math channel** > **Zone, Scale**.

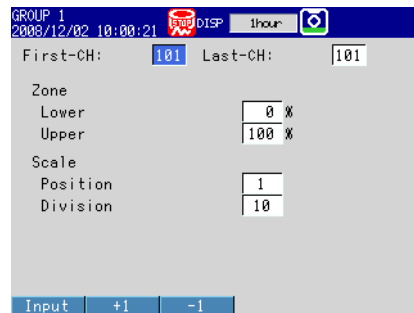

- **Bar Graph Display**

Press **MENU** (to switch to setting mode), and select the **Menu** tab > **Math channel** > **Bar**.

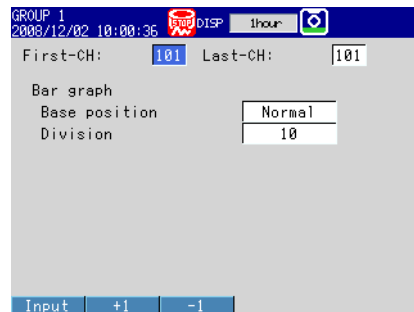

9.3 Displaying the Computation Channels

- **Partial Expanded Display**

Press **MENU** (to switch to setting mode), and select the **Menu** tab > **Math channel** > **Partial**.

* The Partial command appears in the menu if you set Partial to On in Basic Setting Mode.

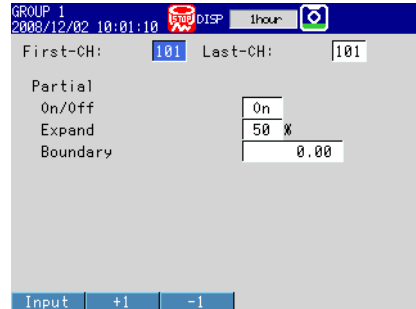

- **Alarm Marks**

Press **MENU** (to switch to setting mode), and select the **Menu** tab > **Math channel** > **Alarm mark**.



- **Color Scale Band**

Press **MENU** (to switch to setting mode), and select the **Menu** tab > **Math channel** > **Color scale band**.

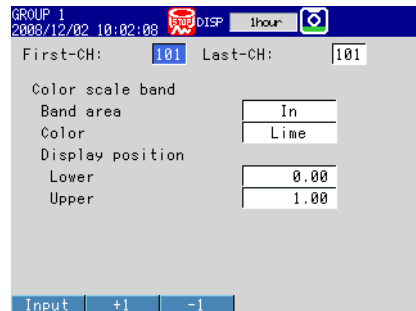

Setup Items

- **Group of channel, First-CH, and Last-CH**
Select the target channel range.
- **Color**
See section 5.5.
- **Zone**
See section 5.6.
- **Partial**
See section 5.9.
- **Bar graph**
See section 5.11.
- **Scale**
See section 5.7.
- **Alarm mark color and Color scale band**
See section 5.8.

9.4 Starting/Stopping Computation, Resetting Computation, and Releasing Computation Data Dropout Display

Setup Screen

- **Action Taken When the START Key Is Pressed**

Press **MENU** (to switch to setting mode), and select the **Menu** tab > **Math channel** > **Math start action**.

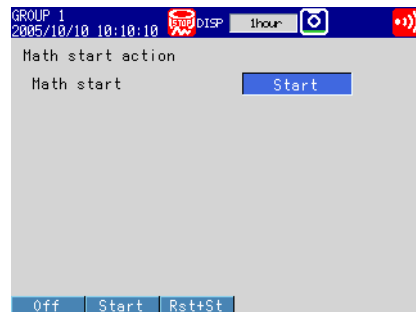

Setup Items

- **Math start action > Math start**

Settings	Description
Off	Does not start the computation even when the START key is pressed.
Start	Starts the computation when the START key is pressed.
Rst+St	Resets the computed result up to then and starts the computation when the START key is pressed.

Procedure

- **Starting the Computation**

- **Starting the Computation Simultaneously with the Memory Sampling**

Press **START**. Computation starts simultaneously with the start of the memory sampling. The computation icon appears in the status display section.

* **Math start** must be set to **Start** or **Rst+St**.

- **Starting Only the Computation**

1. In the operation mode, press **FUNC**.
The **FUNC** key menu appears.

2. Press the **Math start** soft key.
Computation starts, and the computation icon is displayed in the status display section.

- **Stopping the Computation**
 - **Stopping the Computation Simultaneously with the Memory Sampling**

1. Press **STOP**.

A confirmation dialog box appears.

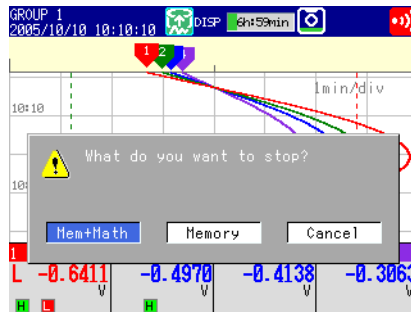

2. Select **Mem+Math** and press **DISP/ENTER**.

The memory sampling and computation stop, and the computation icon in the status display section disappears.

- **Stopping Only the Computation**

1. In the operation mode, press **FUNC**.

The FUNC key menu appears.

2. Press the **Math stop** soft key.

The computation stops, and the computation icon in the status display section disappears.

Note

When the computation is stopped, the computed data of the computation channel is held at the value that existed immediately before the computation is stopped. When memory sampling is in progress, the held value is recorded.

- **Resetting the Computed Results on All Computation Channels**

This operation can be carried out when the computation is stopped. You can carry out this operation even while the computation is in progress on DXs with release number 2 or later.

1. In the operation mode, press **FUNC**.

The FUNC key menu appears.

2. Press the **Math reset** soft key.

The computed results of all computation channels are reset.

- **Releasing the Computation Data Dropout Display**

This operation can be carried out when a computation data dropout occurs. When a computation data dropout occurs, the computation icon turns yellow.

1. In the operation mode, press **FUNC**.

The FUNC key menu appears.

2. Press the **Math ACK** soft key.

The computation icon returns to white.

* **Math ACK** is displayed in the FUNC key menu only when a computation data dropout occurs.

Note

A computation data dropout occurs when the computation process cannot be completed within the scan interval. If computation data dropout occurs frequently, lessen the load on the CPU by reducing the number of computation channels or setting a longer scan interval. If a computation data dropout occurs during memory sampling, the data immediately before the dropout is recorded as the computed data of the scan interval in which the dropout occurred.

9.5 Creating Reports

Set how the reports are created.
For a description of the function, see section 1.8.

Setup Screen

- **Report Computation Type**

Press **MENU** (to switch to setting mode), hold down **FUNC** for 3 s (to switch to basic setting mode), and select the **Environment** tab > **Report**.

Basic Setting Mode Ethernet Link

Report

Report select

1	Ave
2	Max
3	Min
4	Sum

File type Separate

Use Template Not

Max Min Ave Sum Inst

- **Report Type and Time of Creation**

Press **MENU** (to switch to setting mode), hold down **FUNC** for 3 s (to switch to basic setting mode), and select the **Menu** tab > **Report** > **Basic settings**.

Basic Setting Mode Ethernet Link

Report set

Report kind Hour+Day

Date 1

Time (hour) 0 :00

Off Hour Day H+D Next 1/2

- **Source Channels**

Press **MENU** (to switch to setting mode), hold down **FUNC** for 3 s (to switch to basic setting mode), and select the **Menu** tab > **Report** > **Report settings**.

Basic Setting Mode Ethernet Link

Report channel number R01

On/Off On

Channel 001

Sum scale /s

Input +1 -1

Setup Items

- **Report > Report select > 1, 2, 3, and 4**

Select the type of data to output as reports. The only data type that can be set more than once is Off. You cannot set 1 to Off.

Settings	Description
Off	Does not output reports.
Ave	Outputs the average value.
Max	Outputs the maximum value.
Min	Outputs the minimum value.
Sum	Outputs the sum value.
Inst	Outputs the instantaneous value.

- **Report > File type**

Set this item when creating two types of reports such as daily report and monthly report.

Settings	Description
Separate	Saves each type of report to a separate file. For information about how files are divided, see section 1.4.
Combine	Saves the report data of two types in a single file.
Seprt2	Saves each type of report to a separate file. For information about how files are divided, see section 1.4, or see section 1.2 in the <i>Advanced Security Function (AS1) User's Manual</i> . You cannot select Use Template when Seprt2 is selected.

When you change the setting from Combine or Separate to Seprt2, or vice versa, the report data in the internal memory is cleared.

- **Report > Use Template**

When you want to use a report template to create reports, select **Use**. You cannot use this function when **Report > File type** is set to **Seprt2**. The setting is fixed at **Not**.

- **Report set > Report kind**

Select the type of report to be created.

Settings	Description
Hour	Creates hourly reports.
Day	Creates daily reports.
H+D	Creates hourly and daily reports.
Day+Week	Creates daily and weekly reports.
D+M	Creates daily and monthly reports.

- **Report set > Date/Day of the week, Time (hour)**

Set the date or day of the week and the time when the report is to be created. The specified date/time is when the report file is divided. Set the values in the range indicated below. Items with a dash are invalid.

Report Type	Date	Day of Week	Time
Hour	-	-	0 to 23
Day	1 to 28*	-	0 to 23
H+D	-	-	0 to 23
Day+Week	-	SUN to SAT	0 to 23
D+M	1 to 28*	-	0 to 23

* You cannot specify 29, 30, or 31.

Report Time and Date/Time When the Report File Is Divided

Example: When the Date of a daily report is set to **1** and the **Time (hour)** is set to **18:00**

A daily report is created every day at hour 18.

The file storing the report is divided at 18:00 on day 1 of each month.

9.5 Creating Reports

- **Report channel number**
The report is output in order by this number.
- **Report channel number > On/Off**
Select **On** for the report channels to be used.
- **Report channel number > Channel**
Set the channel to assign to the report channel. All channels can be assigned, but reports are not created for channels set to **Skip** or **Off** even if they are assigned. In the stacked bar graph display (see section 4.10 for details), report data is displayed in the following groups. However, only channels that have the same unit as the first channel in the group are displayed.

Report Group	DX1002, DX1004, DX1002N, DX1004N	DX1006, DX1012, DX1006N, DX1012N
1	R01 to R06	R01 to R06
2	R07 to R12	R07 to R12
3	-	R13 to R18
4	-	R19 to R24

- **Report channel number > Sum scale**
Set the sum scale to **/s** to **/day** to match the unit of the measured value.
Example: If the unit of the measured value is "m³/min," select **/min**.
Off: Sums as-is the measured data per scan interval.
- **Handling of Overflow Data**
Overflow data is handled in the same way as it is in statistical computations (TLOG and CLOG).
See section 9.1.

Procedure

- **Starting/Stopping the Report Function**
Starting the memory sampling starts the report function. Likewise, stopping the memory sampling stops the report function.
- **Displaying the Reports**
See section 4.5.
- **Saving the Reports**
See section 1.4.

9.6 Creating a Report Template (Release numbers 4 and later)

This section explains how to make a report template.

To create a report template, you put keywords and text into cells in Excel.

Keywords specify the data that will be entered into a cell. Other text is included in the report as it is written. Save the report templates that you create in XML spreadsheet format. The report template file name extension is .xml.

For a description of the function, see section 1.8.

For the setting procedure, see section 9.5.

To load or save a report template, see section 6.10.

Template Example

Channel Number	\$Ch(R01)\$	\$Ch(R02)\$
Name	Tank 1 temperature	Tank 1 pressure
Unit	\$Unit(R01)\$	\$Unit(R02)\$
\$ReportDataTime(Hour)\$	\$ReportDataInst(Hour,R01)\$	\$ReportDataInst(Hour,R02)\$
\$Repeat\$	\$Repeat\$	\$Repeat\$
\$Repeat\$	\$Repeat\$	\$Repeat\$

Report Example

Channel Number	TIC-001	PIC-002
Name	Tank 1 temperature	Tank 1 pressure
Unit	°C	kPa
2010/04/01 00:00:00	76.5	45.6
2010/04/01 01:00:00	78.9	56.7
2010/04/01 02:00:00	77.7	50.8

Keyword Format

Keywords are written by themselves or with parameters.

\$ Keyword(parameter)\$	Example: \$ReportDataSum(Hour,R01,00,23)\$
-------------------------	--

- **Basic Rules**

- The dollar sign on the left indicates the start of a keyword, and the dollar sign on the right indicates the end of a keyword.
- You can only write keywords using letters of the alphabet, dollar signs, parentheses, commas, and spaces. You can put a space after an opening parenthesis, before and after a comma, and before a closing parenthesis. There is no distinction between uppercase and lowercase letters. You cannot use a dollar sign inside of a keyword.
- The maximum length of a keyword, including spaces, is 100 characters.

- **Parameter Rules**

- Parameters are enclosed in parentheses.
- Multiple parameters (up to 4) are separated by commas.
- Examples of how parameters can be omitted are shown below.

\$ReportDataSum(Hour, R01, ,23)\$	The third parameter is omitted.
\$ReportDataSum(Hour, R01, 01,)\$ or \$ReportDataSum(Hour, R01, 01)\$	The fourth parameter is omitted.

- **Rules That Relate to Excel**

- Set the data format by setting the cell format.
- Set the proper format for each keyword's cell in the cell's Number properties.
- The keyword in a cell is only valid when the keyword name and parameters are all in the same format. When a keyword's font size or some other property is not consistent, it is invalid.

\$ReportDataSum(H our, R01, 00, 23)\$	The font size of "Hour" is different, so the keyword is invalid.
---	--

- When a single cell contains text and a keyword, only the format of the keyword has to be consistent. The format of the text can be different.

Date and time: \$DateTime\$	The format of the keyword is consistent, so it is valid.
------------------------------------	--

Keyword Definitions

For examples of how to use the keywords, see “Report Template Examples.”

• System Keywords

One keyword produces one item of data.

Keyword	Description	Format
Time	Current time on the DX	Time
Date	Current date on the DX	Date
DateTime	Current date and time on the DX	
DateTimeString	Current date and time on the DX	Character string
Serial	DX serial number	
FileHeader	DX file header	
Ch	Channel number ^{*1}	
Tag	Tag comments ^{*1}	
ChId	Tag number ^{*1}	
Unit	Unit ^{*1}	

^{*1} The parameter is the report channel number (it cannot be omitted).

• Report Data Keywords

One keyword produces multiple items of data.

Keyword	Description	Format
ReportDataDate	Report creation date ^{*1}	Date
ReportDataTime	Report creation time ^{*1}	Time
ReportDataDateTime	Report creation date and time ^{*1}	Date
ReportDataDateTimeString	Report creation date and time ^{*1}	Character string
ReportDataStatus	Report data status ^{*2}	Character string
ReportDataSum	Report data sum ^{*2}	Number or character string ^{*3}
ReportDataInst	Instantaneous report data value ^{*2}	
ReportDataAve	Average report data value ^{*2}	
ReportDataMax	Maximum report data value ^{*2}	
ReportDataMin	Minimum report data value ^{*2}	

^{*1} List the parameters in this order: report type (cannot be omitted), report start date and time (can be omitted), report end date and time (can be omitted).

^{*2} List the parameters in this order: report type (cannot be omitted), report channel number (cannot be omitted), report start date and time (can be omitted), report end date and time (can be omitted).

^{*3} The decimal point type (dot or comma) depends on whether the converted data is a value or character string.

Whether the converted data is a value or character string depends on the format of the cell that the keyword is written in. When the cell format is numerical, the decimal point type is determined by the cell format. When the cell format is text, the decimal point type matches the format of the report data.

• Special Keywords

Keyword	Description	Format
Repeat	Specifies the output location of the data that corresponds to a report data keyword.	The same as the corresponding keyword.
Comment	Adds comments to the template. Nothing is displayed after template conversion.	–

9.6 Creating a Report Template (Release numbers 4 and later)

- **Parameters**

Parameter	Format	Range	Description
Report kind	Hour		Hourly report
	Day		Daily report
	Week		Weekly report
	Month		Monthly report
Report channel number	Rxx (xx are numerals)	R01 to R60 (varies by model)	DX report channel
Start date or time	xx (xx are numerals)	00 to 23	Specifies the start time
		01 to 31	Specifies the start date
End date or time	xx (xx are numerals)	00 to 23	Specifies the end time
		01 to 31	Specifies the end date

Starting and Ending Dates and Times

Use the start date and time and end date and time to specify the parts of the report file's report data that you will output to the file that you create with the template. You can specify the starting and ending dates (for daily reports) or times (for hourly reports). Example when the report type is hourly and the report was created at 18:00.

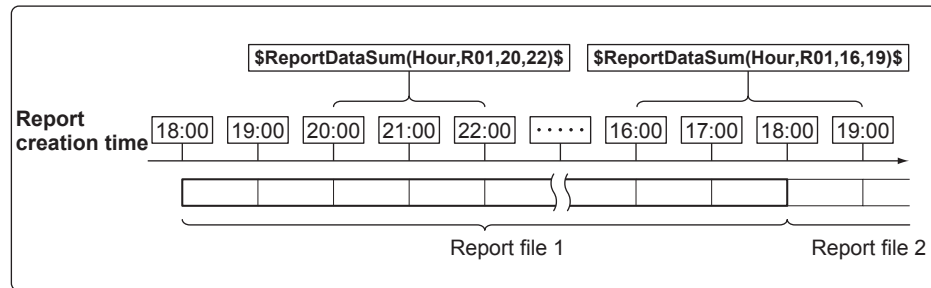

Keyword: `$ReportDataSum(Hour,R01,20,22)$`

From the hourly data from 19:00:01 to 22:00:00, the report data (sums) of report channel R01 for 20:00, 21:00, and 22:00 is output.

Keyword: `$ReportDataSum(Hour,R01,16,19)$`

From the hourly data from 15:00:01 to 19:00:00, the report data (sums) of report channel R01 for 16:00, 17:00, and 18:00 is output. Because the report data for 19:00 is in another report file, it is not output.

Keyword: `$ReportDataSum(Hour,R01)$`

One file's worth (18:00:01 to 18:00:00) of data from report channel R01 is output, starting from 19:00.

When you omit the start and end times for an hourly report, the data for the hour after the report creation time until the 24th hour is output. For daily reports, the data for the day after the report creation time until the end of the month is output.

Keyword: `$ReportDataSum(Hour,R01,08)$`

From the hourly data from 07:00:01 to 18:00:00, the report data (sums) of report channel R01 for 08:00 to 18:00 is output.

Report Template Examples

- **System Keyword Examples**

Mixing a keyword and text

File header: \$FileHeader\$			
Date and time: \$DateTime\$			
↓			
File header: DX2000			
Date and time: 2010/01/01 12:00:00			

Mixing multiple keywords and text

Device number: \$Serial\$ File Header: \$FileHeader\$			
↓			
Device number: ABCDEFG File Header: DX2000			

- **Report Data Keyword Examples**

The following examples are for when the hourly report data for report channel R01 is 101, 102, 103, 104, and 105 and the hourly report data for report channel R02 is 201, 202, 203, 204, 205, and 206.

The \$Repeat\$ command applies to the closest keyword above the command in the same column.

\$ReportDataInst(Hour,R01)\$		101	
\$Repeat\$		102	
\$Repeat\$		103	
\$Repeat\$		104	
\$ReportDataInst(Hour,R02)\$		201	
\$Repeat\$		202	
\$Repeat\$		203	
\$Repeat\$		204	
\$Repeat\$		205	

The \$Repeat\$ command applies to the keyword above it in the same column, even when that keyword is not directly above the command.

\$ReportDataInst(Hour,R01)\$		101	
\$Unit(R01)\$			°C
\$Repeat\$		102	
\$Unit(R01)\$			°C
\$Repeat\$	\$Unit(R01)\$	103	°C

You can mix system keywords, report data keywords, and text. If the data specified by a keyword does not exist, nothing is output.

\$ReportDataInst(Hour,R01)\$(\$Unit(R01)\$)		101(°C)	
\$Repeat\$		102	
\$Repeat\$		103	
\$Repeat\$(\$Unit(R01)\$)		104(°C)	
\$Repeat\$(°C)		105(°C)	
\$Repeat\$			

9.6 Creating a Report Template (Release numbers 4 and later)

Keywords in merged cells are affected by the leftmost cells above them.

	\$ReportDataInst(Hour,R01)\$	\$ReportDataInst(Hour,R02)\$	
	\$Repeat\$	\$Repeat\$	
\$Repeat\$		\$Repeat\$	
	\$Repeat\$	\$Repeat\$	
	↓		
	101	201	
	102	202	
		203	
	103	204	

When a keyword is written incorrectly or its formatting is wrong, the keyword will be output to the file as it is written.

\$ReportDataInst(Hour,R)\$		\$ReportDataInst(Hour,R)\$
\$ReportDataInst(Hour,R02)\$		201
\$Repeat\$		\$Repeat\$
\$Repeat\$		202
\$Repeat\$		203
\$Repeat\$		204
\$ReportDataInst(Hour,R01)\$		101
\$ReportDataInst(Hour,R02)\$		\$ReportDataInst(Hour,R02)\$

*1 When there are multiple system keywords in the same cell, only the first keyword is valid.

10.1 A List of Messages

There are cases in which error codes and messages are displayed on the screen during operation. A list of the possible error codes and messages are given in the table below. Communication error codes and messages are also listed.

Error responses to communication commands are output in English.

Errors Related to Parameter Settings

• Setting Errors

Code	Message	Explanation/Countermeasures/Ref. section
1	System error.	Contact your nearest YOKOGAWA dealer.
2	Incorrect date or time setting.	Enter a correct value.
3	A disabled channel is selected.	Specify a channel that is not set to Skip or Off. Specify a channel that is installed.
4	Incorrect function parameter.	See chapter 3 the communication manual.
5	The input numerical value exceeds the set range.	Enter a proper value.
6	Incorrect input character string.	Enter a proper character string.
7	Too many characters.	Enter the correct number of characters.
8	Incorrect input mode.	Specify a correct mode. See section 3.3.
9	Incorrect input range code.	Specify a correct range code. See section 3.3.
11	Range settings are not same within the selected channels.	Specify channels with the same range setting. See section 3.9.
12	A disabled batch group is selected.	Set the last batch group greater than the first batch group. See section 2.2 in <i>IM04L41B01-03E</i> .
13	Cannot set a trip line for a display group that is OFF.	Check the display group settings. See section 5.1 and section 2.2 in <i>IM04L41B01-03E</i> .
21	Cannot set an alarm for a skipped channel.	Cannot be specified on channels set to Skip. See section 3.7.
22	The upper and lower span limits are equal.	Cannot be set to the same value. See section 3.3.
23	The upper and lower scale limits are equal.	Cannot be set to the same value. See section 3.3.
24	The lower limit of the span band is greater than the upper limit.	Set the lower limit less than the upper limit. See section 3.3.
25	The lower limit of the scale band is greater than the upper limit.	Set the lower limit less than the upper limit. See section 3.3.
30	The partial boundary value exceeds the range of the span.	Set the boundary value in the range of "the minimum span value + 1 digit" to "the maximum span value - 1 digit." See section 5.9.
31	Partial-expansion display is set ON for a SKIPPED channel.	Cannot be specified on channels set to Skip. See sections 3.3 and 5.9
35	The upper and lower limits of the display band are equal.	Set the upper limit greater than the lower limit + 5. See section 5.6.
36	The lower limit of the display band is greater than the upper limit.	Set the upper limit greater than the lower limit + 5. See section 5.6.
37	The display band is narrower than 4% of the entire display.	Set the upper limit greater than the lower limit + 5. See section 5.6.
40	Incorrect group set character string.	Check the syntax. See section 5.1.
41	There is no specified input channel.	Specify a channel that is installed. Operation Guide and section 5.1.
42	Exceeded the number of channels which can be set.	Up to 6 channels per group. See section 5.1.

10.1 A List of Messages

Code	Message	Explanation/Countermeasures/Ref. section
43	A channel number cannot repeat in a group.	Check that a channel is not registered twice. See section 5.1.
45	There is no character string saved in the clipboard.	Copy a character string to the clipboard.
46	The character string saved in the clipboard is too long.	Paste a character string with the specified number of characters.
47	Start and end time cannot match.	Check the starting and ending times. See section 2.1.
48	Invalid or missing DST time settings.	Check the starting and ending times. See section 2.1.
61	There is no channel specified by the MATH expression.	Check the channel number specified by the expression. See sections 1.8 and 9.1.
62	MATH expression grammar is incorrect.	Check that the expression grammar is correct. See section 9.2.
63	MATH expression sequence is incorrect.	Check that the operator used in the expression in relation to the applicable operands meets the grammar requirements. See section 9.2.
64	MATH upper and lower span values are equal.	Set the upper limit not equal to the lower limit. See section 9.1.
65	Too many operators for MATH expression.	The maximum number of operators in an expression has been exceeded. Reduce the number of operators, such as by splitting up the expression into multiple computation channels. See section 9.2.
70	Nonexistent constant specified in MATH expression.	Check the constant number specified by the expression. See section 9.1.
71	Set range of the MATH constant is exceeded.	Check the selectable range. See section 9.1.
80	This username is already registered.	Register another user name. See section 8.2.
81	All space or 'quit' string cannot be specified.	Change the character string. See section 8.2.
83	This user ID and password combination is already in use.	Change the user ID or the password. See section 2.1 in the advanced security manual.
84	The login password has not been set up.	Set a password. See section 8.2.
85	The login password is incorrect.	Check the password. If you lost the password, ask your administrator to reset it. See sections 8.2 and 8.3.
86	The key-lock release password is incorrect.	Check the password. If you lost the password, it must be reset. See section 8.1.
87	This key is locked.	Release the key lock. See section 8.1.
88	This function is locked.	Release the key lock. See section 8.1.
89	Press [FUNC] key to login.	Log in. See section 8.3.
90	No permission to enter to the SETUP mode.	Check the keylock or login settings. See sections 8.2 and 8.3.
91	Password is incorrect.	Enter the correct password. If you lost the password, it must be reset. See sections 8.2 and 8.3.
92	Press [ESC] key to change to the operation mode.	Press the ESC key.
93	String including space or all space cannot be specified.	Spaces are not allowed in the Web browser user name and password. See section 1.5 in the communication manual.
94	More than one address cannot be specified.	Only a single sender is allowed. See section 1.4 in the communication manual.
95	Number entered exceeds channel number range. Use another command.	Check the syntax of the Modbus command. See sections 1.10 and 2.6 in the communication manual.

Code	Message	Explanation/Countermeasures/Ref. section
96	This menu is locked.	Check the key lock setting. Release the key lock. See section 8.1.
97	This function is locked.	To use the function, login as a user who has permission to use it. See section 8.2 in the advanced security manual.
100	IP address doesn't belong to class A, B, or C.	Check the IP address. See section 1.3 in the communication manual.
101	The result of the masked IP address is all 0s or 1s.	Check the subnet mask. See section 1.3 in the communication manual.
102	SUBNET mask is incorrect.	Check the subnet mask. See section 1.3 in the communication manual.
103	The net part of default gateway is not equal to that of IP address.	Check the IP address. See section 1.3 in the communication manual.
105	This port number is already in use. Please enter a different number.	Enter a different port number for each function. See section 6.1 in the communication manual.
110	This user name is not registered.	Log in as a registered user. See section 8.2 and section 2.1 in the advanced security manual.
111	The login user ID is incorrect.	Enter the correct user ID. See the advanced security manual.
112	Password must use more than 6 alphanumeric characters.	The password must be between 6 and 20 characters in length. See section 2.1 in the advanced security manual.
113	Password entered is incorrect.	Enter the correct password. See section 8.3 and section 2.2 in the advanced security manual.
114	This user name is invalid.	Have a system administrator clear the "invalid user" status. See the advanced security manual.
116	This user name cannot be specified.	The user name is reserved. See section 8.2 and the advanced security manual.
117	This password is not effective.	Because the wrong password has been entered consecutively for more than the permissible number of times, this user is invalid. Have an administrator clear the "invalid user" status. See section 2.2 in the advanced security manual.
119	This user name is unable to use this mode.	A user-level user cannot enter the Basic Setting mode See section 8.2.
120	Measured value is incorrect. (in ascending order)	Set the calibration correction value to a value greater than the previous value. See section 3.9.
121	A user is already logged in.	Another user has logged in with the same name or is logging in. See section 1.3 in the advanced security manual.
122	Measured value exceeds the range setting.	Check the channel input or the channel range setting. See sections 3.3 and 3.9.
124	Password entry cannot be performed.	You cannot use bar codes to enter a password. See section 2.9 in the advanced security manual.
125	Character entry cannot be performed.	The DX is not showing a display used to enter character strings. See section 2.11.
126	You cannot use the same password.	Specify a different password. See section 8.3.
127	Report kind overlaps and cannot be set up.	Change the overlapped report data type. See section 9.5.
128	"Logout" cannot be set to "Hide".	See sections 5.17 and 8.3.
129	IP address is not set.	Set the IP address of the DX. See section 1.3 in the communication manual
131	You have exceeded the available channel capacity.	You cannot connect more than 240 channels. See section 1.10 in the communication manual

10.1 A List of Messages

Code	Message	Explanation/Countermeasures/Ref. section
132	You have exceeded the available number of commands.	The maximum number of commands that can be sent is 16. The modules that can be set with a single command are consecutive modules that can be automatically set. Change the MW100 module configuration so that there are no empty slots. See section 1.10 in the communication manual.
133	External I/O auto setting information is not available.	Below are the possible causes. Check them. <ul style="list-style-type: none"> • The MW100 is in calibration mode. Change to the setting mode or measurement mode. • The measurement module may not have been detected. Perform system reconfiguration. • There are no modules that can be automatically set. Check the modules. • An IP address has not been assigned to the MW100. Set the IP address. • The Modbus server of the MW100 is turned OFF. Turn ON the server. See section 1.10 in the communication manual.
134	Auto setting has already been executed.	You cannot set an MW100 that has been automatically set. See section 1.10 in the communication manual.
135	External I/O cannot be found.	Check the Ethernet connection. See section 1.3 in the communication manual.
136	External I/O start cannot be executed.	The current MW100 settings do not allow the measurement to be started. Check the settings. See section 1.3 in the communication manual.
137	DNS for this device is not set.	Set the DNS of the DX. See section 1.3 in the communication manual.
138	Cannot create object. The maximum allowed number was exceeded.	This occurs when the custom display is generated. See section 2.2 in <i>IM04L41B01-04E</i> .
139	This dependency is not possible.	This occurs when the custom display is generated. See section 1.10 in <i>IM04L41B01-04E</i> .
140	You cannot set this while you are logged in.	You cannot change the registered settings of a user that is logged in. See the advanced security manual.
141	You cannot set multiple channels.	During memory sampling, you cannot configure settings for multiple consecutive channels at the same time. See section 1.5 in the advanced security manual.
142	Another user is configuring settings.	You can perform operations after the user who is in setting mode or basic setting mode logs out or returns to operation mode. See the section 1.3 in advanced security manual.

- Execution Errors**

Code	Message	Explanation/Countermeasures/Ref. section
150	This action is not possible because sampling is in progress.	Stop the memory sampling and then execute. See section 6.4.
151	This action is not possible during sampling or calculating.	Stop the memory sampling and then execute. See sections 6.4 and 9.4.
152	This action is not possible because saving is in progress.	Wait until the saving is complete.
153	This action is not possible because formatting is in progress.	Wait until the formatting is complete.
154	Message not accepted because message limit was reached.	The limit is 50 messages. See section 5.4.
155	The message is not written while sampling is stopped.	Start the memory sampling and then execute. See section 6.4.
156	There are no channels to be saved to the memory.	Set the channels to be saved. See sections 6.1 and 9.1.
157	This function is not possible at this time.	Check the DX status.
158	Exceeds time deviation setting.	When synchronizing the clock through remote control. When you specified time that exceeds the time deviation limit on DXs with Advanced security function (/AS1 option). (Firmware version number 4.11 and later) See section 2.3.
159	It is outside the postscript message write-in range.	Add message can be written to the past section of the data being memory sampled. See section 5.4.
162	Data storage is already started.	Memory sampling is in progress on the batch group. See section 3.2 in <i>IM04L41B01-03E</i> .
163	Data storage is already stopped.	Memory sampling on the batch group has already been stopped. See <i>IM04L41B01-03E</i> .
164	This action is not possible because there is a bar code data error.	Check the text that the barcode reader scanned. See section 2.11.
170	End process can't proceed, because setting file is not saved to Media.	When you switch from setting mode to operation mode or basic setting mode, the DX automatically saves the changed settings to the CF card. This message appears when the DX cannot save the changed settings. Check the CF card. See section 1.5 in the advanced security manual.
173	Data save is not possible because of insufficient media capacity.	Change the external storage medium.
174	Cannot execute because of failure to save unsaved setting file.	The DX cannot save an unsaved setting file to the CF card. Check the CF card. See the advanced security manual.
175	The calibration due date has not been set properly.	Check the year, month, and day of the calibration due date. See section 3.13
700	The specified command does not exist.	The command specified from the custom display is not registered. Register commands whose command type is "E-M," and specify the numbers of those commands in the custom display. See section 1.10 in the communication manual. See section 2.32 in <i>IM04L41B01-04E</i> .
701	Saving data.	The previous transmission is not finished. See section 1.10 in the communication manual.
702	Failed to save data.	Check for communication errors or Modbus server errors. See section 1.10 in the communication manual.
760	Cannot find KDC server.	The KDC server cannot be found in the same domain. See section 1.14 in the communication manual.
761	KDC server connection error.	An error occurred while the DX was connecting to the KDC server. See section 1.14 in the communication manual.
764	Not supported by this machine.	Not supported by the DX. See section 1.14 in the communication manual.

10.1 A List of Messages

Code	Message	Explanation/Countermeasures/Ref. section
765	Preauthentication failed.	Preauthentication failed. Check the information that you entered.
766	The encryption type is not supported by this machine.	Use the same encryption method on the DX and the server. See section 1.14 in the communication manual.
767	Failed to receive authentication from KDC server.	Check the DX and server settings. See section 1.14 in the communication manual.
768	Change the password.	The password has expired. See section 1.14 in the communication manual.
769	The time difference with the KDC server exceeds the limit.	There is a time difference of 5 minutes or more between the DX and the server. Eliminate this time difference. See section 1.14 in the communication manual.
771	The host principal is not registered.	The DX account is not registered on the server. See section 1.14 in the communication manual.
772	The host principal is invalid.	Check the DX account that is registered on the server. See section 1.14 in the communication manual.
773	The host password is incorrect.	Make sure that the password set on the DX matches the server password. See section 1.14 in the communication manual.
774	Preauthentication failed.	An internal error occurred during preauthentication. Disable the server's preauthentication function.
775	The realm is incorrect.	Set the correct realm name on the DX. See section 1.14 in the communication manual.

Operation Errors

Code	Message	Explanation/Countermeasures/Ref. section
200	Operation aborted because an error was found in media.	Use another storage medium or format it. See section 6.7.
201	Not enough free space on media.	There is not enough free space on media or the number of directories exceeded the limit. Use another storage medium. See section 1.4.
202	Media is read-only.	Make it writable.
210	Media has not been inserted.	Insert a storage medium into the drive.
211	Media is damaged or not formatted.	Remove the medium and set it again. If an error still occurs, replace or format the medium. See section 6.7.
212	Format error.	Try formatting again. See section 6.7.
213	The file is read-only.	Access another file or make the file writable.
214	There is no file or directory.	Specified a file in which data is being added. Tried to save a file which does not exist in the internal memory.
215	Exceeded the allowable number of directories or files.	Replace a storage medium. Delete unneeded files and directories. See section 6.7.
216	The file or directory name is incorrect.	Use alphanumeric characters and symbols. See section 6.2.
217	Unknown file type.	Check the extension. See section Appendix 2.
218	This directory or file now exists. Delete it or change the name.	See section 6.2.
219	Invalid file or directory operation.	Tried to delete multiple directory levels. Or, tried to delete a directory containing files. Delete the files and directories in the directory first before executing the operation. See section 6.7.
220	The file is already in use. Try again later.	Wait until the file is accessible.
221	This action is not possible because FTP transmission is in progress.	Execute after FTP data transfer is complete.
222	Media is not recognized.	Remove and reset the storage medium.
231	Abnormal setting exists in file.	Specify another file.
232	There is no available data.	Appears when displaying historical trends. Specify another file.
233	The specified historical data do not exist.	Appears when switching to historical trend from information display. See section 4.5.
234	The specified channel is not assigned to the display group.	Appears when switching to trend, digital, or bar graph from overview. See sections 4.4 and 7.6.
235	There is no data for the chosen date.	Select a day of the month that has "E" or "D" displayed. See section 4.3.
236	There is no data after the selected time for this day.	Select an earlier time. Section 4.3.
237	The specified screen cannot be displayed	The DX display mode and the Web display mode are different, or a display group that does not exist has been specified from the Web. See <i>IM04L41B01-03E</i> .
240	You cannot sign this record because a signature is already present.	You cannot overwrite a signature. See section 1.6 in the advanced security manual.
245	This function cannot be used in the historical trend display.	Close the historical trend display.
246	This function cannot be used due to no data file saved in media.	Insert a storage medium. Make sure that the storage medium is formatted.
247	This function cannot be used in setting mode.	Exit setting mode.
249	You cannot sign, because some batch data is missing.	When the process type is batch, you cannot use the DX to sign the measured data unless everything from the start to the stop of measurement is contained in a single file. Use DAQSTANDARD to sign the data. See the advanced security manual.

10.1 A List of Messages

Code	Message	Explanation/Countermeasures/Ref. section
250	Failed to load template file.	The template file that you attempted to load is 400 KB or larger. Load a template file that is smaller than 400 KB.
251	There is no template file.	There is no template file in the internal memory. Load a template file.
252	The template file is incorrect.	Check the template file format.

Communication Application Errors

• Errors Related to E-mail and Web Server

260	IP address is not set or ethernet function is not available.	The IP address is not specified. Check the IP address. See section 1.3 in the communication manual.
261	SMTP server is not found.	Occurs when the SMTP server is specified by name. • Check the DNS setting. • Check the SMTP server name. See sections 1.3 and 1.4 in the communication manual.
262	Cannot initiate E-mail transmission.	• The host name of the DX is not correct. Check the host name. • The port number of the SMTP server is not correct. Check the port number. See sections 1.3 and 1.4 in the communication manual.
263	Sender's address rejected by the server.	Check the sender's address. Section 1.4 in the communication manual
264	Some recipients' addresses are invalid.	Check the recipients' addresses. See section 1.4 in the communication manual.
265	SMTP protocol error.	May occur if a network failure (cable problems, duplicate addresses, network device failure, and so on) occurs in the middle of the e-mail transmission.
266	Ethernet cable is not connected.	Check the cable connection. See section 1.3 in the communication manual.
267	Could not connect to SMTP server.	• Check to see that the SMTP server is connected to the network. • If the SMTP server name is specified using an IP address, check to see that the IP address is correct. See section 1.4 in the communication manual.
268	E-mail transmission request failed.	Contact your nearest YOKOGAWA dealer.
269	E-mail transfer error.	May occur if a network failure (cable problems, duplicate addresses, network device failure, and so on) occurs in the middle of the e-mail transmission.
270	Could not connect to POP3 server	Check the connection settings. See section 1.4 in the communication manual.
271	Not able to login to the POP3 server.	Check the login name and the password. See section 1.4 in the communication manual.
272	SMTP authentication failed.	Make sure that the user name and password that you are using for authentication are recognized by the server. See section 1.4 in the communication manual.
273	The server requested an unsupported authentication method.	Change the server configuration. See section 1.4 in the communication manual.
275	The current image cannot be output to the Web.	The setup display cannot be output to the Web browser. This message is displayed on the Web browser.
276	Image data currently being created. Unable to perform key operation.	Try again a little later. This message is displayed on the Web browser.
277	Could not output screen to Web.	Failed to create the image. This message is displayed on the Web browser.
278	Web control denied because a user has control.	You cannot control the DX from a browser when: • There is a user who is logging in or who has logged into the DX through key operations. • There is a user who has logged into the DX through communication commands. See section 1.5 in the communication manual.

10.1 A List of Messages

- **Errors Related to FTP Client**

For a description of the FTP client function of the DX, see the *Communication Interface User's Manual, IM 04L41B01-17E*. The detail code does not appear in the error message on the screen. You can view the code on the FTP log display of the DX or using the FTP log output via communications.

Code	Message
280	IP address is not set or FTP function is not available. Further details are provided by the character string that appears after error code 280. <hr/> Character String and Details <hr/> HOSTADDR An IP address has not been assigned to the DX. Check the IP address. DORMANT Internal processing error.*1 LINK Data link is disconnected. Check the cable connection.
281	FTP mail box operation error. Further details are provided by the character string that appears after error code 281. <hr/> Character String and Details <hr/> MAIL Internal processing error.*1 STATUS Internal processing error.*1 TIMEOUT Internal processing error.*1 PRIORITY Internal processing error.*1 NVRAM Internal processing error.*1
282	FTP control connection error. Further details are provided by the character string that appears after error code 282. <hr/> Character String and Details <hr/> HOSTNAME Failed the DNS lookup (search the IP address corresponding to the host name). Check the DNS setting and the destination host name. TCPIP Internal processing error.*1 UNREACH Failed to connect to a control connection server. Check the address setting and that the server is running. OOBINLINE Internal processing error.*1 NAME Internal processing error.*1 CTRL The control connection does not exist. Check that the server does not drop the connection and that it responds within the proper time period. IAC Failed to respond in the TELNET sequence. Check that the server does not drop the connection and that it responds within the proper time period. ECHO Failed to transmit data on the control connection. Check that the server does not drop the connection and that it responds within the proper time period. <hr/> Character String and Details <hr/> REPLY Failed to receive data on the control connection.

Code	Message
	<p>Check that the server does not drop the connection and that it responds within the proper time period.</p> <p>SERVER</p> <p>The server is not in a condition to provide the service.</p> <p>Check that the server is in a condition in which service can be provided.</p>
283	<p>FTP command was not accepted.</p> <p>Further details are provided by the character string that appears after error code 283.</p> <hr/> <p>Character String and Details</p> <hr/> <p>USER</p> <p>Failed to verify the user name.</p> <p>Check the user name setting.</p> <p>PASS</p> <p>Failed to verify the password.</p> <p>Check the password setting.</p> <p>ACCT</p> <p>Failed to verify the account.</p> <p>Check the account setting.</p> <p>TYPE</p> <p>Failed to change the transfer type.</p> <p>Check that the server supports the binary transfer mode.</p> <p>CWD</p> <p>Failed to change the directory.</p> <p>Check the initial path setting.</p> <p>PORT</p> <p>Failed to set the transfer connection.</p> <p>Check that the security function is disabled.</p> <p>PASV</p> <p>Failed to set the transfer connection.</p> <p>Check that the server supports PASV commands.</p> <p>SCAN</p> <p>Failed to read the transfer connection settings.</p> <p>Check that proper response to the PASV command is received from the server.</p>
284	<p>FTP transfer setting error.</p> <p>Further details are provided by the character string that appears after error code 284.</p> <hr/> <p>Character String and Details</p> <hr/> <p>MODE</p> <p>Internal processing error.¹</p> <p>LOCAL</p> <p>Internal processing error.¹</p> <p>REMOTE</p> <p>The destination file name is not correct.</p> <p>Check that you have the authority to create or overwrite files.</p> <p>ABORT</p> <p>File transfer abort was requested by the server.</p> <p>Check the server for the reason for the abort request.</p>

10.1 A List of Messages

Code	Message
285	FTP data connection error. Further details are provided by the character string that appears after error code 285. Character String and Details SOCKET Failed to create a socket for the transfer connection. ² BIND Failed the transfer connection command. ² CONNECT Failed the transfer connection. ² LISTEN Failed the transfer connection reception. ² ACCEPT Failed to accept the transfer connection. ² SOCKNAME Internal processing error. ¹ RCV Failed to receive data over the transfer connection. ² SEND Failed to send data over the transfer connection. ²
286	FTP file transfer error.
287	FTP is failed because of file acquirement from external media.
290	SNTP access failure. Further details are provided by the character string that appears after error code 290. Character String and Details DORMANT Internal processing error. ¹ LINK Data link is disconnected. Check the cable connection.
291	SNTP server does not respond. Further details are provided by the character string that appears after error code 291. Character String and Details TIMEOUT Check that the server is running. ²
292	Incorrect SNTP server setting. Further details are provided by the character string that appears after error code 292. Character String and Details HOSTNAME Failed the DNS lookup (search the IP address corresponding to the host name). Check the DNS setting and the SNTP server name. TCPIP Internal processing error. ¹
293	Invalid SNTP server reply. Further details are provided by the character string that appears after error code 293. Character String and Details SEND A correct IP address has not been assigned to the DX. Check the IP address. BROKEN There is a problem with the SNTP server. If this error occurs even after executing SNTP manually several times, check the SNTP server.

Code	Message
294	<p>No time correction because excess time deviation with SNTP server.</p> <p>Further details are provided by the character string that appears after error code 294.</p> <p>Character String and Details</p> <p>OVER</p> <p>This error occurs when periodic SNTP is executed by the auto setting of the clock and the clock is not adjusted because the time difference between the DX and the SNTP server is greater than or equal to 10 minutes.</p> <p>Check the time on the DX and the SNTP server.</p>
295	<p>IP address was released because DHCP setting is invalid.</p> <p>Further details are provided by the character string that appears after error code 295.</p> <p>Character String and Details</p> <p>REJECT</p> <p>Address obtained by DHCP is inappropriate.</p>
296	<p>DHCP access failure.</p> <p>Further details are provided by the character string that appears after error code 296.</p> <p>Character String and Details</p> <p>ESEND</p> <p>Failed to transmit to the DHCP.</p> <p>ESERVER</p> <p>DHCP server not found.</p> <p>ESERVFAIL</p> <p>No response from the DHCP server.</p> <p>ERENEWED</p> <p>Address renewal rejected.</p> <p>EEXTENDED</p> <p>Address lease extension rejected.</p> <p>EEXPIRED</p> <p>Address lease period expired.</p>
297	<p>Registration of the hostname to the DNS server failed.</p> <p>Further details are provided by the character string that appears after error code 297.</p> <p>Character String and Details</p> <p>INTERNAL</p> <p>Failed to register the host name (transmission error, reception timeout, etc.).</p> <p>FORMERR</p> <p>Failed to register the host name (format error: DNS message syntax error).</p> <p>SERVFAIL</p> <p>Failed to register the host name (server failure: DNS server processing error).</p> <p>NXDOMAIN</p> <p>Failed to register the host name (non existent domain).</p> <p>NOTIMP</p> <p>Failed to register the host name (not implemented).</p> <p>REFUSED</p> <p>Failed to register the host name (operation refused).</p> <p>YXDOMAIN</p> <p>Failed to register the host name (name exists).</p> <p>YXRRSET</p> <p>Failed to register the host name (RR set exists).</p> <p>NXRRSET</p> <p>Failed to register the host name (RR set does not exist).</p> <p>NOTAUTH</p> <p>Failed to register the host name (not authoritative for zone).</p> <p>NOTZONE</p> <p>Failed to register the host name (different from zone section).</p> <p>NONAME</p> <p>Host name not entered on the DX.</p>

10.1 A List of Messages

Code	Message
298	Deletion of the hostname to the DNS server failed. Further details are provided by the character string that appears after error code 298. Character String and Details
	INTERNAL Failed to delete the host name (transmission error, reception timeout, etc.).
	FORMERR Failed to delete the host name (format error: DNS message syntax error).
	SERVFAIL Failed to delete the host name (server failure: DNS server processing error).
	NXDOMAIN Failed to delete the host name (non existent domain).
	NOTIMP Failed to delete the host name (not implemented).
	REFUSED Failed to delete the host name (operation refused).
	YXDOMAIN Failed to delete the host name (name exists).
	YXRRSET Failed to delete the host name (RR set exists).
	NXRRSET Failed to delete the host name (RR set does not exist).
	NOTAUTH Failed to delete the host name (not authoritative for zone).
	NOTZONE Failed to delete the host name (different from zone section).
	NOTLINKED 4Physical layer was disconnected when removing the host name.
700	The specified command does not exist.
701	Saving data.
702	Failed to save data.

*1 Contact your nearest YOKOGAWA dealer.

*2 These errors may occur if the network experiences trouble during the data transmission (bad cable connection, duplicate addresses, network equipment failure).

Note

- The FTP client function on the DX has a timer function that drops the connection if there is no data transfer for two minutes. If the server does not respond within this time period, the transfer fails.
 - The FTP client function on the DX overwrites files without a warning if files with the same name exist at the transfer destination unless the server returns a negative response.
-

Communication Errors

For information regarding the communication function of the DX, see the *Communication Interface User's Manual, IM 04L41B01-17E*.

- **Errors during Setting and Basic Setting Modes, Output Communication Command Execution, and Setup Data Loading**

Code	Message
300	Command is too long.
301	Too many number of commands delimited with ';'.
302	This command has not been defined.
303	Data request command can not be enumerated with sub-delimiter.
350	Command is not permitted to the current user level.
351	This command cannot be specified in the current mode.
352	The option is not installed.
353	This command cannot be specified in the current setting.
354	This command is not available during sampling or calculating.

- **Memory Access Errors during Setting and Basic Setting Modes and Output Communication Command Execution**

An English error message is returned via the communication interface. It is not displayed on the screen.

Code	Message
362	There are no data to send 'NEXT' or 'RESEND'.
363	All data have already been transferred.

- **Maintenance and Test Communication Command Errors**

An English error message is returned via the communication interface. It is not displayed on the screen.

Code	Message
390	Command error.
391	Delimiter error.
392	Parameter error.
393	No permission.
394	No such connection.
395	Use 'quit' to close this connection.
396	Failed to disconnect.
397	No TCP control block.
398	Format error.

10.1 A List of Messages

- **Other Communication Errors**

An English error message is returned via the communication interface. It is not displayed on the screen.

Code	Message
400	Input username. Enter the name of a user that is registered on the DX and that is allowed to log in to the DX through communication.
401	Input password. Enter the password.
402	Select username from 'admin' or 'user'. Select "admin" or "user" to specify the user level to connect to.
403	Login incorrect, try again! The login failed. Enter the information again, starting with the user name.
404	No more login at the specified level is acceptable. Connecting would cause the maximum number of simultaneous connections (administrator: 1, normal user: 2 or setting: 1, monitoring: 2) to be exceeded. Connect to a different level, or exit by entering "quit."
405	Input user ID. Enter a user ID.
406	Select function from 'setting' or 'monitor'. Select "setting" (to connect to the setting function) or "monitor" (to connect to the monitoring function).
407	Password has expired. Please enter a new password. The password has expired. Enter a new password.
408	Enter password again for confirmation. Enter the password again for confirmation.
409	This password is not correct or was already used. The password is incorrect or has already been used.
410	Login successful. (The special user level) You have logged in to the administrator level.
411	Login successful. (The general user level) You have logged in to the user level.
420	Connection has been lost. The connection has been lost.
421	The number of simultaneous connection has been exceeded. The maximum number of simultaneous connections has been reached, so no further connections can be made.
422	Communication has timed-out. Communication timed out so the connection was closed.
450	This entry is incorrect. You cannot currently log in. This may happen for one of the following reasons: <ul style="list-style-type: none">• The user name is not registered.• The user name is invalid.• The user ID is wrong.
451	Login prohibited because another user is logged in. Another user is already logged in. This may happen for one of the following reasons: <ul style="list-style-type: none">• Someone has already logged in with the same user name.• When the multi-login function is not enabled and someone has logged in through key operations.
452	This command must be used with LL command. Use the LL command.

Status Messages

Code	Message
500	Execution is complete.
501	Please wait a moment...
503	Data are being saved to media...
504	File is being loaded from media...
505	Formatting...
506	Memory save to media was interrupted.
508	There is no file or directory.
509	Press [DISP/ENTER] key to display file name.
510	Range cannot be changed during sampling or calculating.
511	MATH expression cannot be changed during sampling or calculating.
513	Post process in progress.
514	Now loading historical data.
515	Data save is completed.
516	Files are now being sorted.
520	Connecting to the line...
521	The data file is being transferred.
530	Media can be removed safely.
531	Media was removed compulsorily.
532	USB device has been connected.
533	USB device cannot be recognized.
534	There was no data which is not saved to media.
535	Media was recognized.
542	Media read error.
543	Flash write error.
550	The A/D calibration is being executed...
551	FTP test is being executed...
552	E-mail test is being executed...
553	Review and sign functions cannot be used when the file is divided.
554	Signature functions are being executed.
555	Login prohibited because software login is active.
556	Press [FUNC] key to login.
557	This user is not allowed to change a setting.
558	Setting changes are aborted while data is saved.
559	This command must be used with LL command.
560	Now connecting to SNTP server...
561	Now adjusting the time.

10.1 A List of Messages

Code	Message
562	Ethernet cable is disconnected. Further details are provided by the character string that appears after error code 562. Character String and Details ON Detected that an Ethernet cable was connected. OFF Detected that an Ethernet cable was disconnected.
563	The command is sent to DHCP. Further details are provided by the character string that appears after error code 563. Character String and Details RENEW Requesting address renewal to the DHCP server.
564	The response was received from DHCP. Further details are provided by the character string that appears after error code 564. Character String and Details RENEWED Address renewal complete. EXTENDED Address release extension request complete. RELEASED Address release complete.
565	IP address was set. Further details are provided by the character string that appears after error code 565. Character String and Details IPCONFIG Assigned the IP address.
566	It is a setting that doesn't register hostname to the DNS server. Further details are provided by the character string that appears after error code 566. Character String and Details NOREQUEST Configured not to register the host name.
567	The hostname was registered to DNS server. Further details are provided by the character string that appears after error code 567. Character String and Details UPDATE Registered the host name to the DNS server.
568	The hostname was deleted from DNS server. Further details are provided by the character string that appears after error code 568. Character String and Details REMOVE Assigned the IP address. OFF Removed the host name from the DNS server.
571	Querying KDC server.
572	Saving template file.
573	Loading template file.

Warning Messages

Code	Message	Ref. Section
600	Measured data and Settings have been initialized.	–
601	Measured data have been initialized.	–
610	This user name is already registered.	See section 8.2.
611	There is no user who can enter to the SETUP mode.	–
612	Please acknowledge all active alarms before stopping this record.	This message appears if you try to stop recording when there is an alarm that the alarm ACK operation has not been performed on. You can either stop recording or perform the alarm ACK operation and then stop recording. See the See sections 6.3 and 6.4 in the advanced security manual.
614	Calibration settings are reset because of range setting change.	See section 3.9.
615	Noise may influence measurement in test mode.	See section 3.1.

For information about messages whose codes are in the 700s, see page 11-5.

System Errors

Servicing is required when a system error occurs. If this happens, contact your nearest YOKOGAWA dealer for repairs.

Code	Message
901	ROM failure.
902	RAM failure.
910	A/D memory failure for all input channels.
921	Channel 1 A/D calibration value error.
925	A/D calibration error.
930	Memory acquisition failure.
940	The Ethernet module is down.
950	Incorrect number for the A/D calibration.
951	Failed to write A/D calibration value.

10.2 Troubleshooting

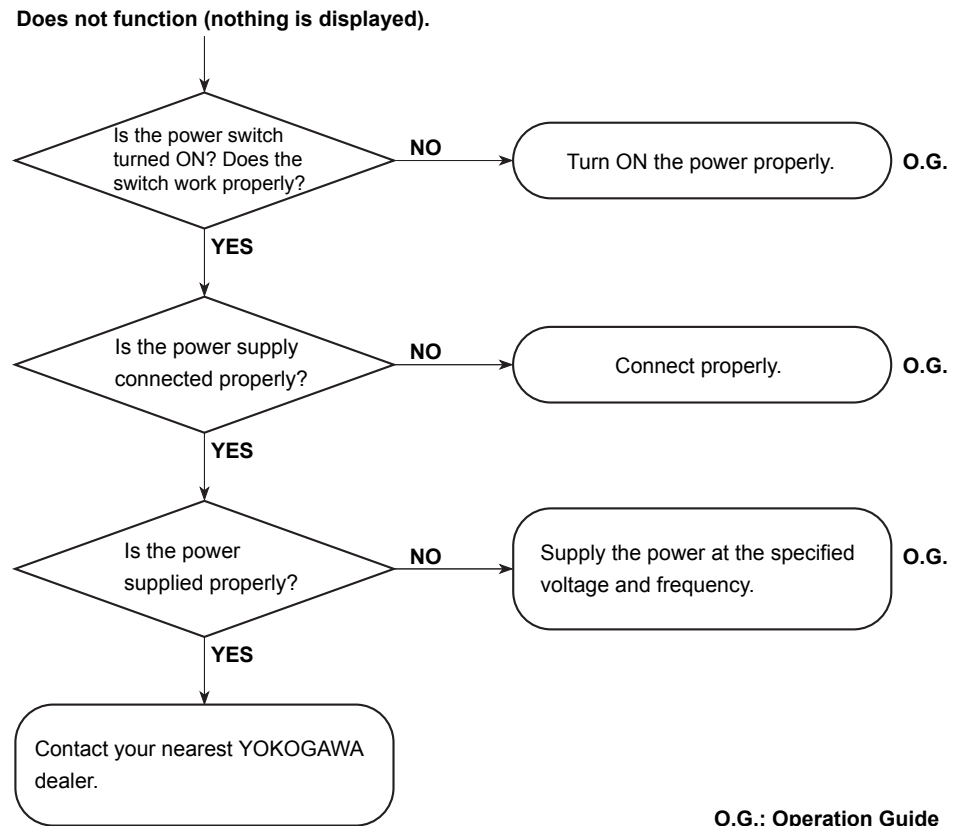

- Large measurement errors
- Trend or digital wave value fluctuation
- Trend going off the scale beyond either 0% or 100%

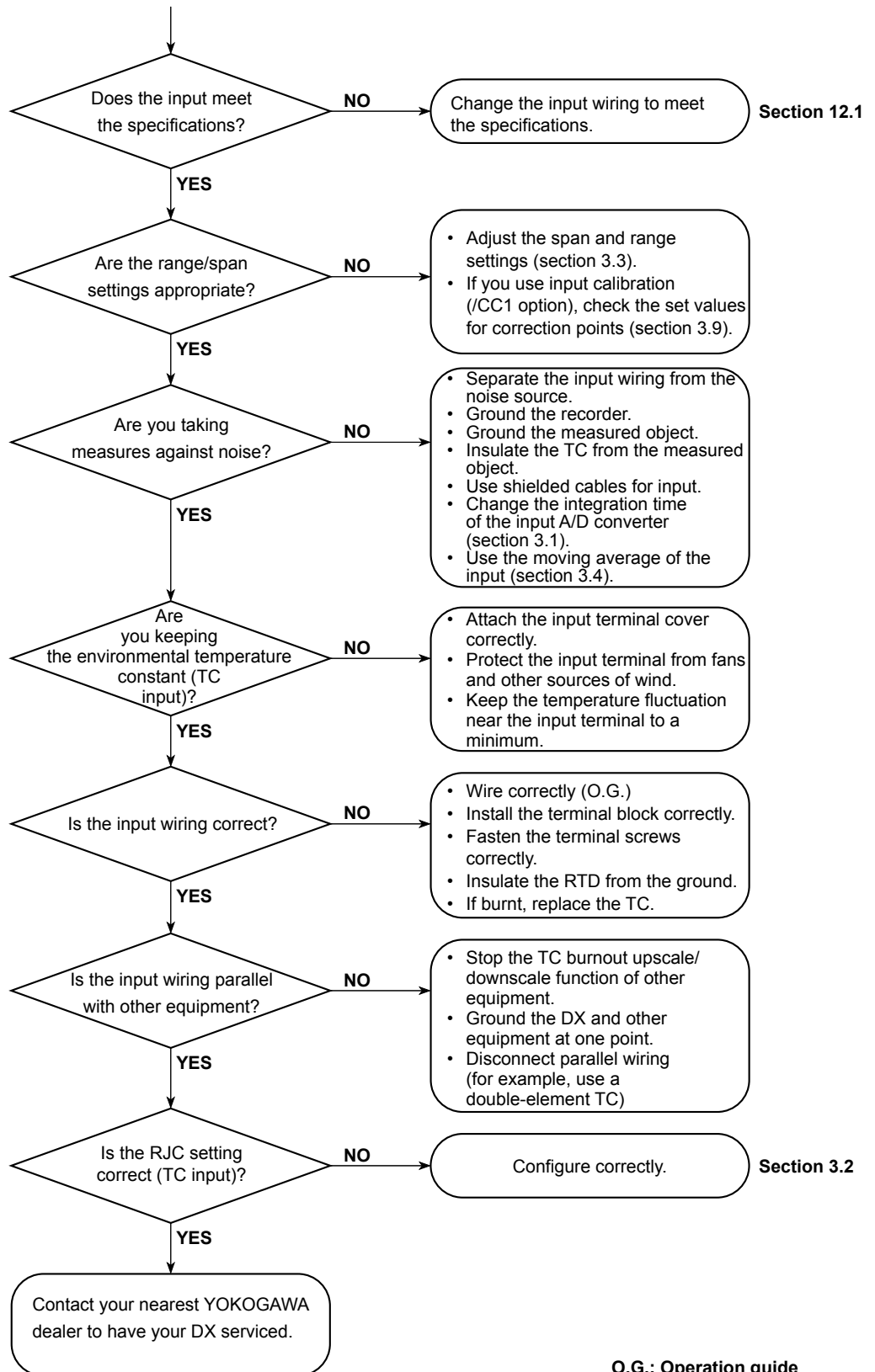

O.G.: Operation guide

10.2 Troubleshooting

Display and other functions do not work properly.

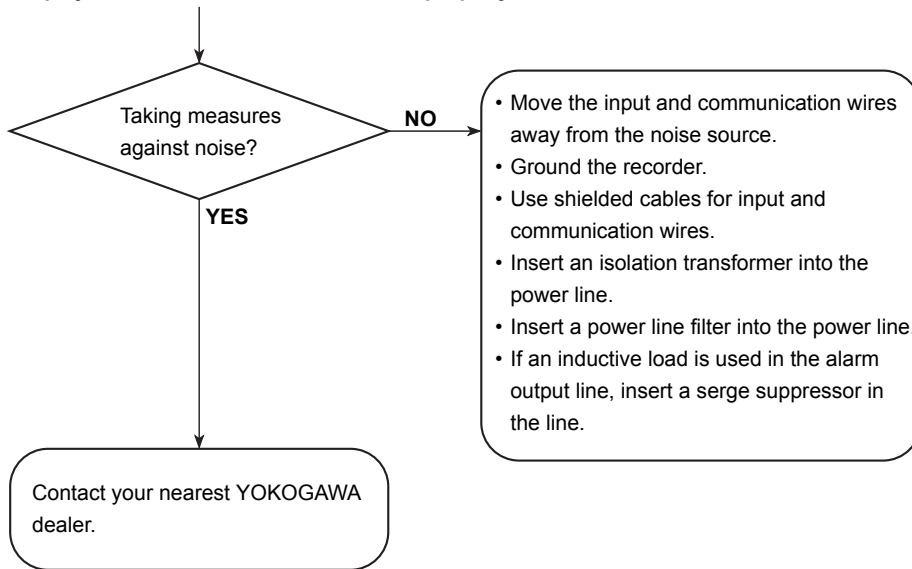

Items on the display selection menu or FUNC key menu are not displayed.

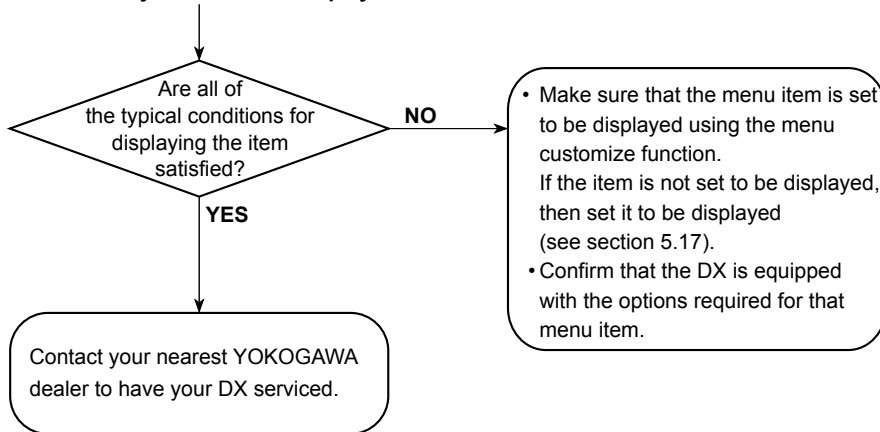

11.1 Periodic Inspection

Check the operation periodically to keep the DX in good working order.

Perform the following checks and replace worn parts as needed.

- Is the display and storage functioning properly?
If not, see chapter 11, “Troubleshooting” in the *DX1000/DX1000N User’s Manual*.
- Has the brightness of the LCD backlight deteriorated?
If replacement is necessary, see “Recommended Replacement Periods for Worn Parts.”

11.2 Calibrating the DX

It is recommended that the DX be calibrated once a year to assure its measurement accuracy.

Calibration service is also provided by YOKOGAWA dealers.

For details, contact your nearest YOKOGAWA dealer.

Required Instruments

Calibration instruments with the following resolution are required for calibrating the DX.

Recommended Instruments

- DC voltage standard: Fluke 9100 or equivalent
Main specifications
Output accuracy: $\pm(0.005\% + 1 \mu\text{V})$
- Decade resistance box: Yokogawa Meters & Instruments Model 2793-01 or equivalent
Main specifications
Accuracy of output range 0.1 to 500 Ω : $\pm(0.01\% + 2 \text{ m}\Omega)$
Resolution: 0.001 Ω
- 0°C standard temperature device: ZC-114/ZA-10 by Coper Electronics or equivalent
Main specifications
Standard temperature stability accuracy: $\pm 0.05^\circ\text{C}$

For information on purchasing the calibration instruments, contact your nearest YOKOGAWA dealer.

Calibration Procedure

1. Wire the DX and the calibration instrument as shown in the following figure, and adequately warm up the instruments (the warm-up time of the DX is at least 30 minutes).
2. Check that the operating environment such as ambient temperature and humidity is within the standard operating conditions (see section 13.6).
3. Apply appropriate input signals corresponding to 0, 50, and 100% of the input range and calculate the errors from the readings.
If the error does not fall within the accuracy range of the specifications, contact your nearest YOKOGAWA dealer.

Note

For thermocouple inputs, you must measure the temperature of the input terminal and apply a voltage taking into account the reference junction temperature.

DC Voltage Measurement (Example for the DX1012)

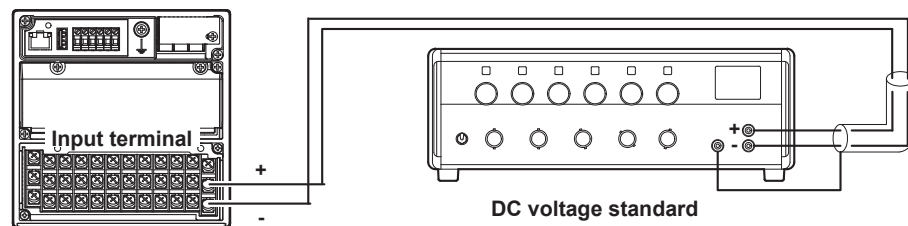

Temperature Measurement When Using an RTD (Example for the DX1012)

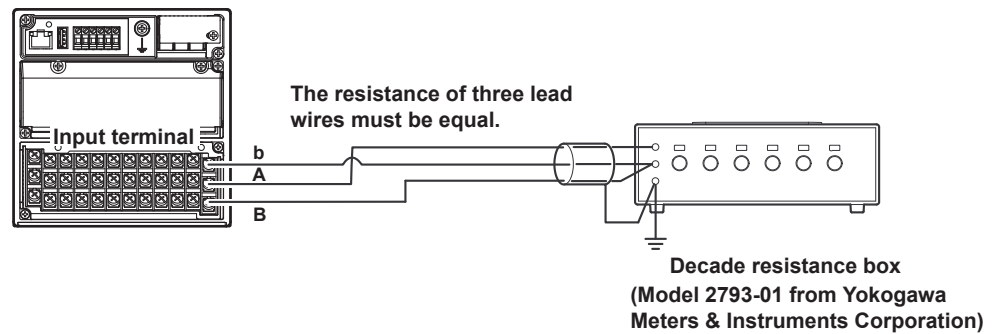

Temperature Measurement When Using a Thermocouple (Example for the DX1012)

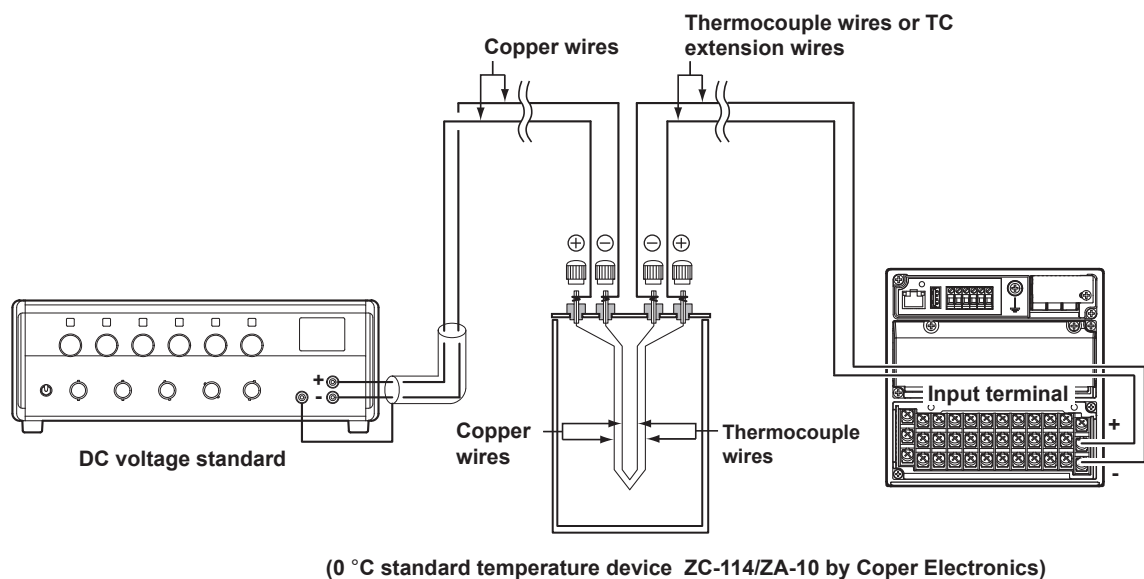

RJC of TC Input

As the measurement terminal of the DX is generally at room temperature, the actual output of the thermocouple is different from the values given on the thermoelectromotive force table based on 0°C. The DX performs compensation by measuring the temperature at the input terminal and adding the corresponding thermoelectromotive force to the actual output of the thermocouple. Therefore, when the measurement terminal is shorted (equivalent to the case when the detector tip is 0°C), the measured value indicates the temperature of the input terminal.

When calibrating the DX, this compensation voltage (thermoelectromotive force of 0°C reference corresponding to the input terminal temperature) must be subtracted from the output of the standard generator before application. As shown in the figure, by using the 0°C standard temperature device to compensate the reference junction at 0°C, you can input the thermoelectromotive force of 0°C reference from the DC voltage standard and perform the calibration.

11.3 Pulling Out the Inner Instrument (DX1000N)

The inner instrument of the DX1000N can be pulled out.

Because some areas inside the DX have high voltages, be sure to pull out the inner instrument correctly. For the procedure, see the *Daqstation DX1000/DX1000N/DX2000 Service Manual, SM 04L41B01-01E*.

12.1 Signal Input and Alarm

Measurement Input

Item Specifications

Number of inputs, scan interval, and A/D integration time

Model	Number of Inputs	Scan Interval		
		Normal Mode		Fast Sampling Mode*
DX1002, DX1002N	2	125 ms, 250 ms		25 ms
DX1004, DX1004N	4			
DX1006, DX1006N	6	1 s, 2 s, 5 s	2 s, 5 s	125 ms
DX1012, DX1012N	12			
A/D converter integration time		60 Hz/50 Hz	60 Hz/50 Hz/100 ms	600 Hz (fixed)

* When using the multi batch function (/BT2) the DX do not have a fast sampling mode.

Input Type DC voltage, 1-5V, thermocouple (TC), resistance temperature detector (RTD), ON/OFF input (DI), and DC current (by adding an external shut resistor)

Measurement range and measurable range

Input Type	Range	Measurable Range		
DC voltage	20 mV	-20.000 to 20.000 mV		
	60 mV	-60.00 to 60.00 mV		
	200 mV	-200.00 to 200.00 mV		
	2 V	-2.0000 to 2.0000 V		
	6 V	-6.000 to 6.000 V		
	20 V	-20.000 to 20.000 V		
	50 V	-50.00 to 50.00 V		
1-5V	1 to 5 V*6	0.800 to 5.200 V		
Thermocouple	R*1	0.0 to 1760.0°C	32 to 3200°F	
	S*1	0.0 to 1760.0°C	32 to 3200°F	
	B*1	0.0 to 1820.0°C	32 to 3308°F	
	K*1	-200.0 to 1370.0°C	-328 to 2498°F	
	E*1	-200.0 to 800.0°C	-328.0 to 1472.0°F	
	J*1	-200.0 to 1100.0°C	-328.0 to 2012.0°F	
	T*1	-200.0 to 400.0°C	-328.0 to 752.0°F	
	N*1	-270.0 to 1300.0°C, on models with release numbers 3 and later. 0.0 to 1300.0°C, on models with release numbers 2 and earlier.	-454 to 2372°F, on models with release numbers 3 and later. 32 to 2372°F, on models with release numbers 2 and earlier.	
	W*2	0.0 to 2315.0°C	32 to 4199°F	
	L*3	-200.0 to 900.0°C	-328.0 to 1652.0°F	
RTD	U*3	-200.0 to 400.0°C	-328.0 to 752.0°F	
	WRe*4	0.0 to 2400.0°C	32 to 4352°F	
	Pt (Pt100)*5 JPt (JPt100)*5	-200.0 to 600.0°C -200.0 to 550.0°C	-328.0 to 1112.0°F -328.0 to 1022.0°F	
DI	Level	0: Less than 2.4 V. 1: 2.4 V or higher (judged at the 6 V range)		
	Contact*7	0: Open. 1: Closed (parallel capacitance of 0.01 µF or less)		

*1: R, S, B, K, E, J, T, N: IEC584-1 (1995), DIN IEC584, JIS C1602-1995

*2: W: W-5%Re/W-26%Re (Hoskins Mfg. Co.), ASTM E988

*3: L: Fe-CuNi, DIN43710, U: Cu-CuNi, DIN43710

*4: WRe: W-3%Re/W-25%Re (Hoskins Mfg. Co.)

*5: Pt100: JIS C1604-1997, IEC751-1995, DIN IEC751-1996

JPt100: JIS C1604-1989, JIS C1606-1989

Measuring current: $i = 1\text{mA}$ (Pt100, JPt100)

*6: The range for linear scaling of 1-5V inputs. Burnout detection and low-cut functions are available.

*7: The detected current value is approx. 10 µA.

12.1 Signal Input and Alarm

Item	Specifications
Thermocouple burnout*	Burnout upscale/downscale selectable (for each channel). Normal: 2 k Ω or less., Burnout: 100 k Ω or more (parallel capacitance of 0.01 μ F or less) Detection current: Approx. 10 μ A
1-5 range burnout*	Burnout upscale/downscale selectable (for each channel). Burnout detection: Greater than "scale upper limit + 10% of scale width" (upscale) ,or "scale lower limit – less than 5% of scale width" (downscale)
TC reference junction compensation	Internal reference junction compensation or external reference junction compensation
Filter function	Takes the moving average of the input values (for each channel). Moving average data points: 2 to 400
Computation	
Difference computation	Computable range: DC voltage, TC, RTD, and DI
Linear scaling	Computable range: DC voltage, TC, RTD, and DI Scalable range: –30000 to 30000. The decimal place is within 4 digits to the right of the decimal point. Unit: 6 digits or less Over value detection: The value can be set to over value when \pm 5% of the scale range is exceeded.
Square root computation	Takes the square root of the input and apply linear scaling Computable type: DC voltage Scalable range and unit: Same as linear scaling Low-cut: Set the low-cut value in the range of 0.0% to 5.0% of the span. Over value detection: Same as linear scaling
1-5V	Computable range: 1-5 Scalable range and unit: Same as linear scaling Low-cut: The low-cut point is fixed to the span lower limit. Over value detection: Same as linear scaling

* In fast sampling mode, burnouts on all measurement channels cannot be detected within a scan interval. Burnout may not be detected until the number of measurements indicated below is carried out if measurement is started in a burnout condition or after a burnout occurs.
DX1002, DX1004, DX1002N and DX1004N: Up to 4 measurements. DX1006, DX1012, DX1006N and DX1012N: Up to 2 measurements.

Alarms

Item	Specifications
Number of alarms	Up to four alarms (level) for each measurement channels
Levels and colors	You can change the alarm colors and display order by setting priorities and colors for each alarm (release number 3 or later). The alarm level and color settings are shared by all channels.
Alarm type	High limit, low limit, difference high limit, difference low limit, high limit on rate-of-change alarm, low limit on rate-of-change alarm, delay high limit, and delay low limit
Alarm delay time	1 to 3600 s (for each channel)
Rate-of-change calculation interval of rate-of-change alarms	1 to 32 times the scan interval (common to all channels)
Alarm output	Output to the internal switch Number of internal switches: 30 Internal switch operation: AND/OR operation selectable
Hysteresis	High and low limit alarm: 0.0 to 5.0% of the span (common to all channels) Difference high and low limit alarms: 0.0 to 5.0% of the span (common to all channels)
Display	Displays the status on the respective operation screen and an alarm icon on the status display section when an alarm occurs. Display operation: Hold or not hold the display until the alarm acknowledge operation.
Alarm hide function (alarm no logging function)	Not display alarms nor record to the alarm summary (for each channel)
Alarm information	Displays a log of alarm occurrences on the alarm summary.
Alarm Annunciator function (release number 3 or later)	Alarm displays and relay output operations can be made to follow an alarm sequence. There are three supported alarm sequences: ISA-A-4, ISA-A, and ISA-M. First-out display function: none

12.2 Display Function

Display

Item	Specifications
Display*	5.5-inch TFT color LCD (240 × 320 dots)
Brightness	8 levels
Backlight saver function	Dim or turn off the LCD backlight if there is no key operation for a specified time.

* A section of the LCD monitor may contain pixels that are always on or off. The brightness of the LCD may also not be uniform due to the characteristics of the LCD. This is not a malfunction.

Displayed Information

Item	Specifications
Display groups	Assign channels to groups on the trend display, digital display, and bar graph display and display.
Number of groups	10
Number of channels that can be assigned to each group	Up to six
Display color	Channel: Select from 24 colors Background: Select white or black (excludes the Overview, Alarm annunciator, and Custom displays. See the item on the Historical trend display for information on that display.)
Trend display	
Waveform line width	Select from 1, 2, and 3 dots
Display method	Orthogonal axis display with time axis (T) and measured value axis (Y) Layout: Vertical, horizontal, wide, or split Trend intervals: 5 s, 10 s*, 15 s, 30 s, 1 min, 2 min, 5 min, 10 min, 15 min, 20 min, 30 min, 1 h, 2 h, 4 h, and 10 h/div for the DX1002, DX1002N, DX1004, and DX1004N. 15 s (only in fast sampling mode*), 30 s, 1 min, 2 min, 5 min, 10 min, 15 min, 20 min, 30 min, 1 h, 2 h, 4 h, and 10 h/div for the DX1006, DX1006N, DX1012, and DX1012N. * release number 3 or later
Scale	Switchable to the secondary trend interval. Display a scale for each channel. Current value bar graph, color scale band, and alarm point marks can be displayed on the scale.
Others	Grid (divisions: 4 to 12), trip line (line width: 1, 2, or 3 dots), message, zone display, partial expanded display, auto zone display (release number 3 or later), fine grid (release number 3 or later), and tag detail display (release number 3 or later)
Digital Display	Displays measured values numerically
Update rate	1 s (scan interval if the scan interval is greater than 1 s)
Bar graph display	Displays the measured value on a bar graph
Direction	Vertical or horizontal
Base position	End or center
Update rate	1 s (scan interval if the scan interval is greater than 1 s)
Scale	Display a scale for each channel Color scale band, and alarm point marks can be displayed on the scale.
Historical trend display	Redisplays the display data or event data in the internal memory or external storage medium.
Display formats	All screen or half screen (only when the display data is being redisplayed) Top channel (release number 3 or later): Displays the specified channel in front of all the others. Auto span display (release number 3 or later): Automatically adjusts the display span of the specified channel. Auto zone display (release number 3 or later): Displays channels in different zones.
Time axis operation	The time axis can be reduced or expanded, and data can be displayed continuously. The time display can be switched from absolute to relative time (release number 3 or later).
Add message	Messages can be added.
Background color	Select from white, cream, black, or light gray.
Data search	Waveforms from the internal memory can be displayed through the specification of a date and time (release number 3 or later).
Overview Display	Displays the measured values of all channels and the alarm statuses.

12.2 Display Function

Information display	
Alarm summary display	Displays a log of up to 1000 alarms. Specify an alarm with the cursor and jump to the corresponding section on the historical trend display.
Message summary display	Time and content of up to 450 messages (including 50 add messages) Specify a message with the cursor and jump to the corresponding section on the historical trend display.
Memory summary display	Displays the information of the data in the memory. Specify a file with the cursor and jump to the corresponding section on the historical trend display. Save the data in the internal memory to the external storage medium using keys.
Report (/M1 and /PM1)	Displays report data from the internal memory
Stacked bar graph (/M1 and /PM1; Release number 3 or later)	Displays the report data of each report group in a stacked bar graph. Display formats: H+D (hourly data is used for the display), Day+Week (daily data is used for the display), D+M (daily data is used for the display) Report groups: Report channels are arranged in groups of sixes starting with the first channel (R001). The group arrangements are fixed. Scale/grid: Fixed at four divisions Update interval: 1 s The report data of the channels in the specified group is displayed in a stacked bar graph. However, only channels that have the same unit of measurement as the first channel in the group are displayed.
Status Display	Relay status display: Displays the ON/OFF status of the alarm output relay and internal switch. Modbus client status: Displays the communication status on the Modbus client Modbus master condition: Displays the communication status on the Modbus master Event switch display (release number 3 or later): Displays the status of the event level switches.
Log display	Displays the login log (only for the DX without /AS1), error log, communication log, FTP log, Web log, e-mail log, SNTP log, DHCP log, Modbus log, operation log (/AS1 option; release numbers 4 and later), and change settings log (/AS1 option; release numbers 4 and later)..
Alarm annunciator display (release number 3 or later)	Display windows: 24 max. Display window label characters: 32 characters × 5 lines max. Comment text blocks are used.
Custom display	Through operations such as size adjustments and attribute configurations, display components (such as the trend, digital, and bar graph displays) can be arranged to create a custom display. The display data that is created can be saved to internal memory or to an external medium (CF). The saved data can be loaded and displayed. Number of displays: 28 (3 in the internal memory and 25 in a CF card)
System information display	Displays the number of measurement and computation channels, options, remote controller ID, MAC address, firmware version, and internal memory capacity.
Network information display	Displays the DX network setup information.

Other Displayed Information

Item	Specifications
Tag display	<p>Tag numbers and comments can be displayed.</p> <p>Tag numbers (release number 3 or later)</p> <ul style="list-style-type: none"> Up to 16 characters Displayable characters: Alphanumeric characters Tag numbers can be enabled or disabled. <p>Tag comments</p> <ul style="list-style-type: none"> 32 characters on a DX with a release number of 3 or later. 16 characters on a DX with a release number of 2 or earlier. Displayable characters: Alphanumeric characters
Message	Write messages to the trend display.
Number of messages	100
Maximum number of saved messages	400
Character	Up to 32 alphanumeric characters
Write method	Write a preset message or write an arbitrary message on the spot.
Write destination	Select only the displayed group or all groups.
Auto message	<p>Write a message when the DX recovers from a power failure while memory sampling is in progress.</p> <p>Write a message when the trend interval is switched during memory sampling.</p>
Add message	Write messages to the past data positions.
Message	The same as the "Message" item above
Maximum number of saved messages	50
Status display section	Displays the DX status at the upper section of the display.
Displayed contents	Year, month, day, time, displayed group name/display name, user name (when using the login function), batch name (when using the batch function), internal memory status, external storage medium status, alarm status, and function usage status (key lock , computation function, and e-mail)
Auto switching of displayed groups	<p>Switches the display group at a given interval.</p> <p>Interval: Select from the available settings between 5 s and 1 min.</p>
Default display	<p>Specify the display to be shown automatically when keys are not operated.</p> <p>Time until the display switches: Select from the available settings between 1 min and 1 h.</p>
Favorite display	<p>Register frequently used displays to the Favorite key and show them through simple operation.</p> <p>Up 8 displays can be registered.</p>
Language	Select English, Japanese, German, French, or, Chinese.
Display selection menu customization	<p>Show/hide and change the positions of each item in the display menus and sub menus</p> <p>Insert/delete separators.</p>
FUNC key menu customization	Show/hide and change the display positions of each item.
Comments display (release number 3 or later)	Displays comments (from a comment text block) when events occur.
Comment text blocks	50
Comment text block contents	Comment text blocks consist of 5 comment text fields.
Comment text fields	100
	<p>Characters: up to 32 characters</p> <p>Displayable characters: Alphanumeric characters</p>

12.3 Data Saving Function

Configuration

Item	Specifications
Internal memory	Temporarily saves various types of data.
Medium	Flash memory
External storage medium	
Medium	CF card (up to 2 GB)
Format	FAT32 or FAT16

Data Type

Item	Specifications	
DX data types and file extensions		
Data Type	Extension	Notes
Display data	.DAD	
	.DSD	/AS1, release numbers 4 and later
Event data	.DAE	
	.DSE	/AS1, release numbers 4 and later
Manual sampled data	.DAM	
Screen image data	.PNG	
Setup data	.PDL	
	.PEL	/AS1, release numbers 4 and later
Report data	.DAR	/M1 and /PM1
	.xml	/M1 and /PM1, release numbers 4 and later
Custom display setup data	.CDC	Release numbers 3 and later
Change settings log data	.TXT	/AS1, release numbers 4 and later

Display Data and Event Data

Item	Specifications
Internal memory	
File storage capacity	400 MB (standard memory; release numbers 4 and later)
Number of files	Up to 400
Operation	FIFO (First In First Out)
Display data	
Target	Measurement/computation input channel
Sampling intervals	Determined by the sample rate. 25 ms, 125 ms, 250 ms, 500 ms, 1 s, 2 s, 5 s, 10 s, 30 s, 1 min, 2 min, 5 min, 10 min, 15 min, 20 min and 30 min (15 min, 20min, and 30min are only available on releases 3 and later) An interval that is shorter than the scan interval cannot be set.
Description	Maximum or minimum value per sampling interval
Data size	Measurement input channel data: 4 bytes/data value. Computation channel data: 8 bytes/data value.
File size	Up to 8 MB
Data format	Binary
Recording	Records data at all times.
Event data	
Target	Measurement/computation input channel.
Sampling interval	Select from the available settings between 25 ms to 600 s.
Description	Data per sampling interval
Data size	Measurement input channel data: 2 bytes/data value. Computation channel data: 4 bytes/data value.
File size	Up to 8 MB
Data format	Binary
Mode	Free: Records data at all times. Trigger: Starts recording data when a certain event occurs and records for the specified interval.
Combinations of saved data	Display data only, event data only, or display data and event data.
File size	See appendix 1.

Manual Sampled Data

Item	Specifications
Item	Measured value at an arbitrary time
Maximum number of data values that the internal memory can store	400
Data format	Text

Report Data (/M1 and /PM1)

Item	Specifications
Item	Report at each scheduled time of report
Maximum number of reports that the internal memory can store	100
Data format	Text or XML spreadsheet (release numbers 4 and later)

Snapshot Data

Item	Specifications
Item	Displayed screen image data
Data format	PNG
Output destination	CF card or communication output

Saving Data to the External Storage Medium

Item	Specifications
Data Saving	Saves the data in the internal memory to the external storage medium.
Manual save	Saves when the external storage medium is inserted with a key operation.
Auto save	Display data: Every file save interval Event data: Every data length Manual sampled data: When manual sampling is executed. Report data: When report is created. Snapshot data: When a snapshot is taken
Auto save operation	Select "save data only if there is sufficient free space on the CF card" or "constantly retain the most recent data files in the CF card (media FIFO)" (release number 2 or later).
File name	Select from "sequence number+user-assigned string+date," "sequence number+user-assigned string," or "sequence number+batch name."
Save destination	Auto save: CF card. Manual save: CF card or USB flash memory (/USB1) Directory name: Specify using up to 20 characters.

Change Settings Log Data (/AS1; release numbers 4 and later)

Item	Specifications
Item	Log of setting changes
Maximum number of data values that the internal memory can store	200
Data format	Text
Output destination (auto save)	SET0 directory on the CF card A file name that includes the execution date is automatically attached.

Setup Data

Item	Specifications
Item	DX setup data
Data format	Binary
File name	Specify using up to 32 characters.
Output/read destination (for saving/loading)	CF card or USB flash memory (/USB1)
Output destination (auto save; when the settings are changed on a DX with the /AS1 option)	SET0 directory on the CF card A file name that includes the execution date is automatically attached.

12.3 Data Saving Function

Custom Display Setup Data

Item	Specifications
Contents	Custom display layout settings
Format	Text
File name	Up to 32 characters
Save/load destination	CF card

Data File Loading

Item	Specifications
Function	Load and show the display data or event data in a CF card or USB flash memory (/USB1).

Miscellaneous

Item	Specifications
Header comment	Add up to 50 characters of comment to display data, event data, manual sampled data, or report data file.

12.4 Other Standard Functions

Event Action Function

Item	Specifications
Event action	Execute a specified operation when a given event occurs.
Number of settings	40
Events	Remote control input, etc.
Timer	Number of timers: 4
Match time timer	Number of timers: 4
Action	Specify memory start/stop, alarm ACK, etc. There are limitations on the combinations of events and actions.

Security Function

Item	Specifications
Key lock function	Limitations to key operation, access to the external storage medium, and various operations
Login function	Only registered users can operate the DX.
System administrators	5 administrators
Users	30 users

Time Related Functions

Item	Specifications
Clock	With a calendar function
Accuracy	± 10 ppm (0 to 50°C), excluding a delay (of 1 second, maximum) caused each time the power is turned on.
Time setting	Using key operation, communication command, event action function, or SNTP client function
Time adjustment method	
While memory sampling	Corrects the time by 40 ms for each second. Limit in which the time is gradually adjusted: Select from the available settings between 10 s and 5 min. If the time is outside the limit, the time is immediately corrected. Cannot be used after hour 0 on January 1st, 2038.
While memory is stopped	Immediately change the time.
DST	The date/time for switching between standard time and DST can be specified.
Time zone	Sets the time difference from GMT.
Date format	Select YYYY/MM/DD, MM/DD/YYYY, DD/MM/YYYY, or DD.MM.YYYY.

Types of Characters That Can Be Handled

Item	Specifications
Characters	Alphabet characters, numbers, and symbols (limitation exists)

Miscellaneous

Item	Specifications
Decimal point type (release number 3 or later)	Period or comma

12.4 Other Standard Functions

Communication Functions

Item	Specifications
Electrical and mechanical specifications	Conforms to IEEE 802.3 (Ethernet frames conform to the DIX specification).
Medium	Ethernet (10BASE-T)
Implemented protocols	TCP, IP, UDP, ICMP, ARP, DHCP, HTTP, FTP, SMTP, SNMP, Modbus, and DX-dedicated protocols
E-mail client	Automatically send e-mail at specified times.
FTP client	Automatically transfer data files to the FTP server. Applicable files: Display data, event data, screen image data, and report data
FTP Server	Transfer files, delete files, manipulate directories, and output file lists of the DX.
Web server	Shows the DX display on a Web browser.
SNTP client	Inquires the time to the SNTP server and sets the DX. Cannot be used after hour 0 on January 1st, 2036.
SNTP server	Outputs the DX time. Time resolution: 5 ms Cannot be used after hour 0 on January 1st, 2036.
DHCP client	Automatically obtain the network address settings from the DHCP server.
Modbus client	Reads data from another device and writes to the registers.
Modbus server	Loads measurement and computation channel data Loads and writes communication input data Some control commands such as memory start Modbus client register access limitations
Setting/Measurement server	Operate, set, and output data of the DX using a dedicated protocol.
Maintenance/test server	Outputs connection information and network information.
Instrument information server	Outputs information (serial number, model name, etc.) of the connected DX.
EtherNet/IP server	Can join an EtherNet/IP network as an adapter (server) Loads measurement and computation channel data Loads and writes communication input data

Batch Function

Item	Specifications
Function	Data management using batch names. Enter text fields and batch comments in the data file.
Batch name Structure	Added to the file name of the display data and event data. Batch number (up to 32 characters) + lot number (up to 8 digits)
Text field	Adds text to the display data and event data. There are 24 available text fields for release numbers 3 and later. There are 8 available text fields for release numbers 2 and earlier. Up to 20 title characters and 30 other characters can be entered per field.
Batch comment	Adds text to the display data and event data. Up to 3 comments with 50 characters or less.

12.5 Options

Alarm Output Relay (/A1, /A2, and /A3)

Item	Specifications
Action	Outputs relay contact signals from the terminals on the rear panel when alarms occur.
Number of outputs	2 outputs (/A1), 4 outputs (/A2), and 6 outputs (/A3)
Relay contact rating	250 VAC (50/60 Hz)/3 A, 250 VDC/0.1 A (for resistance load)
Output format	NO-C-NC
Relay operation	Energized/deenergized, AND/OR, hold/non-hold, and reflash settings are selectable.

RS-232 Interface (/C2) and RS-422/485 Interface (/C3)

Item	Specifications
Connection	EIA RS-232(/C2) or EIA RS-422/485(/C3)
Protocol	Dedicated protocol or Modbus protocol
Synchronization	Start-stop synchronization
Transmission mode (RS-422/485)	Four-wire half-duplex multi-drop connection (1:N (N = 1 to 32))
Data rate	1200, 2400, 4800, 9600, 19200, or 38400 bps
Data length	7 or 8 bits
Stop bit	1 bit
Parity	Odd, even, or none
Handshaking	Off:Off, XON:XON, XON:RS, and CS:RS
Communication distance (RS-422/485)	1200 m
Modbus communication	Operation modes: Master or slave

FAIL/Status Output Relay (/F1)

Item	Specifications
Relay operation assignment	You can select which operations to assign to the two relays (release numbers 4 and later).
FAIL output	Relay contact output on CPU error
Relay operation	Energized during normal operation and de-energized on system error.
Status output	Output a relay contact signal when a selected condition occurs. A combination of the following conditions can be selected: Low memory, memory failure, media error, A/D hardware error, burnout detection, communication error (Modbus master or client communication error), alarm occurrence
Relay operation	Relay is energized when a condition occurs.
Relay contact rating	250 VAC (50/60 Hz)/3 A, 250 VDC/0.1 A (for resistance load)

Clamped Input Terminal (Detachable) (/H2)

Item	Specifications
Input terminal	Make the input section clamp input terminals (detachable). Recommended wire size: 0.08 to 1.5 mm ² (AWG 28 to 16)

12.5 Options

Desktop Type (/H5[]) ---

Item	Specifications
Construction	With carrying handle. /H5D, /H5F, /H5R, /H5J, /H5H: Power Inlet connector. With a power cord. /H5: Can only be specified when /P1 is simultaneously specified. Screw type power terminal. Without power cord.

Computation Function (including the report function) (/M1) ---

Item	Specifications
Number of computation channels	DX1002, DX1004, DX1002N, and DX1004N: 12 channels (101 to 112) DX1006, DX1012, DX1006N, and DX1012N: 24 channels (101 to 124)
Operation	General arithmetic operations: Four arithmetic operations, square root, absolute, common logarithm, natural logarithm, exponential, and power Relational operations: <, ≤, >, ≥, =, and ≠ Logic operations: AND, OR, NOT, and XOR Statistical operations: TLOG or CLOG Special operations: PRE, HOLD, RESET, and CARRY Conditional operation: [a?b:c]
Computation accuracy	Double-precision floating point
Data that can be used	
Channel data	Measurement and computation channels
Constants	60 constants
Communication input data	24
Remote control input status	0/1 (/R1)
Pulse input	Counts the number of pulses (/PM1)
Status input	Internal switch, alarm output relay (/A[]), flags, and recording (memory sampling) status (release number 3 or later)
Rolling average	Performs moving average on the computed results.
Measurement range	–9999999 to 99999999 Decimal place: 0 to 4 digits to the right of the decimal point
Alarms	High limit, low limit, delay high limit, and delay low limit Hysteresis: High and low limit alarm: 0.0% to 5.0% of the span.
Display	Same as the measurement channels
Data saving	Same as the measurement channels
Report function	Number of report channels: 12 or 24 (same as the number of computation channels) Computation types: Average, maximum, minimum, sum, or instantaneous value Report types: Hourly, daily, hourly + daily, daily + weekly, daily + monthly Report templates (report output according to templates in XML spreadsheet format; release numbers 4 and later). Templates (xml files) are available on Excel 2003 or later.

Cu10, Cu25 RTD Input/3 Leg Isolated RTD Input (/N1)

Item	Specifications
Function	In addition to the standard input, the DX can also receive Cu10 and Cu25 input. On the DX1006, DX1012, DX1006N, and DX1012N, all the RTD input terminals (A, B, and b) are isolated on each channel.

Measurement/display accuracy
Under standard operating conditions

Input Type	Setting	Measurement Range	Accuracy Guaranteed Range	Measurement Accuracy		Max. Resolution
				A/D integration time: 16.7 ms or more	A/D integration time: 1.67 ms	
Cu10 (GE)	Cu1	-200.0 to 300.0°C	-70.0 to 170.0°C	±(0.4% of rdg + 1.0°C)	±(0.8% of rdg + 5.0°C)	0.1°C
Cu10 (L&N)	Cu2		-75.0 to 150.0°C			
Cu10 (WEED)	Cu3		-200.0 to 260.0°C			
Cu10 (BAILEY)	Cu4		-200.0 to 300.0°C			
Cu10:α=0.00392 at 20°C	Cu5		-200.0 to 300.0°C	±(0.3% of rdg + 0.8°C)	±(0.5% of rdg + 2.0°C)	
Cu10:α=0.00393 at 20°C	Cu6					
Cu25:α=0.00425 at 0°C	Cu25					

* Measuring current $i = 1$ mA

Input source resistance 1 Ω or less per wire (The resistance of all three wires must be equal).

Ambient temperature influence (applies when the A/D integration time is 16.67 ms or greater)

±(0.2% of range + 2 digits) or less

Input source resistance With variation of 1 Ω per wire (resistance of all three wires must be equal): ±(0.1% of rdg + 1 digit) or less

With maximum difference of 40 mΩ between wires: Approx. 1 °C

12.5 Options

3 Leg Isolated RTD Input (/N2)

Item	Specifications
Input terminal	All the RTD input terminals (A, B, and b) are isolated on each channel. Applies to DX1006, DX1012, DX1006N, and DX1012N Note: On the DX2004 and DX2008 standard models, all the terminals (A, B, and b) are already isolated on each channel

Extended Input Type (/N3)

Item	Specifications
Measurement/display accuracy	Under standard operating conditions

Input Type	Measurement Range	Measurement Accuracy			Max. Resolution	
		A/D integration time: 16.7 ms or more		A/D integration time: 1.67 ms		
Thermocouple	Kp vs Au7Fe	0.0 to 300.0K	0 to 20 K	Within ±4.5 K	Within ±13.5 K	0.1K
			20 to 300 K	Within ±2.5 K	Within ±7.5 K	
	PLATINEL	0.0 to 1400.0°C	±(0.25% of rdg + 2.3°C)		±(0.25% of rdg + 8.0°C)	0.1°C
	PR40-20	0.0 to 1900.0°C	0 to 450°C	Accuracy not guaranteed	Accuracy not guaranteed	
			450 to 750°C	±(0.9% of rdg + 3.2°C)	±(0.9% of rdg + 15.0°C)	
			750 to 1100°C	±(0.9% of rdg + 1.3°C)	±(0.9% of rdg + 6.0°C)	
			1100 to 1900°C	±(0.9% of rdg + 0.4°C)	±(0.9% of rdg + 3.0°C)	
	NiNiMo	0.0 to 1310.0°C	±(0.25% of rdg + 0.7°C)		±(0.5% of rdg + 3.5°C)	
	W/WRe26	0.0 to 2400.0°C	0 to 400°C	±15.0°C		
			400 to 2400°C	±(0.2% of rdg + 2.0°C)	±(0.4% of rdg + 4.0°C)	
Type N(AWG14)	0.0 to 1300.0°C	±(0.2% of rdg + 1.3°C)		±(0.5% of rdg + 7.0°C)		
XK GOST*2	-200.0 to 600.0	-200 to -100°C	±(0.25% of rdg + 1.0°C)			
		-100 to 600°C	±(0.25% of rdg + 0.8°C)			
RTD*1	Pt50	-200.0 to 550.0°C	±(0.3% of rdg + 0.6°C)		±(0.6% of rdg + 3.0°C)	0.1K
	Ni100(SAMA)	-200.0 to 250.0°C	±(0.15% of rdg + 0.4°C)		±(0.3% of rdg + 2.0°C)	
	Ni100(DIN)	-60.0 to 180.0°C	±(0.15% of rdg + 0.4°C)		±(0.3% of rdg + 2.0°C)	
	Ni120	-70.0 to 200.0°C	±(0.15% of rdg + 0.4°C)		±(0.3% of rdg + 2.0°C)	
	J263*B	0.0 to 300.0K	0 to 40 K	Within ±3.0 K	Within ±9.0 K	
			40 to 300 K	Within ±1.0 K	Within ±3.0 K	
	Cu53	-50.0 to 150.0°C	±(0.15% of rdg + 0.8°C)		±(0.3% of rdg + 4.0°C)	0.1°C
	Cu100	-50.0 to 150.0°C	±(0.2% of rdg + 1.0°C)		±(0.4% of rdg + 5.0°C)	
	Pt25	-200.0 to 550.0°C	±(0.15% of rdg + 0.6°C)		±(0.3% of rdg + 3.0°C)	
	Pt100GOST*2	-200.0 to 600.0°C	±(0.15% of rdg + 0.3°C)		±(0.3% of rdg + 1.5°C)	
	Cu100 GOST*2	-200.0 to 200.0°C	±(0.15% of rdg + 0.3°C)		±(0.3% of rdg + 1.5°C)	
	Cu50 GOST*2	-200.0 to 200.0°C	±(0.4% of rdg + 0.5°C)		±(0.8% of rdg + 2.5°C)	
	Cu10 GOST*2	-200.0 to 200.0°C	±(1.5% of rdg + 3.0°C)		±(3.0% of rdg + 15.0°C)	
	Pt46 GOST*2	-200.0 to 550.0°C	±(0.3% of rdg + 0.8°C)		±(0.6% of rdg + 4.0°C)	
Pt200 (WEED)*3	-100.0 to 450.0°C	±(0.3% of rdg + 0.6°C)		±(0.6% of rdg + 3.0°C)		

*1 Measuring current $i = 1 \text{ mA}$

*2 Available for release numbers 3 and later.

*3 Available for release numbers 4 and later. Double the resistance of a 100 ohm Platinum (TCR = .003902 ohms/ohm/°C) Curve A resistor made by Weed Instrument.

Input source resistance	Thermocouple input: 2 kΩ or less RTD input: 1 Ω or less per wire (The resistance of all three wires must be equal).
Ambient temperature influence (applies when the A/D integration time is 16.67 ms or greater)	
TC input	±(0.1% of rdg + 0.05% of range) or less, excluding the error of reference junction compensation
RTD input	±(0.2% of range + 2 digits) or less
Input source resistance	
TC input	With variation of +1 kΩ: ±10 μV or less
RTD input	With variation of 1 Ω per wire (resistance of all three wires must be equal): ±(0.1% of rdg + 1 digit) or less With maximum difference of 100 mΩ between wires: Approx. 1 °C

Remote Control (/R1)

Item	Specifications
Number of input terminals	8
Input type	Isolated from the main circuitry through a photocoupler, built-in isolated power supply for the input terminals, and shared common.
Input type and signal level	
Voltage-free contact	Contact closed at 200 Ω or less and contact open at 100 k Ω or greater. The remote contact input operation can be set to normal open or normal close (release number 3 or later)
Open collector	ON voltage: 0.5 V or less (sink current 30 mA or more), leakage current when OFF: 0.25 mA or less
Allowable input voltage	5 VDC
Signal type	Level or edge (250 ms or more)
Action	Executes a specified action by applying a given signal to the remote signal input terminal. Action assignment: Set using the event action function

24 VDC Transmitter Power Supply (/TPS2 and /TPS4)

Item	Specifications
Number of loops	2 (/TPS2) or 4 (/TPS4)
Output voltage	22.8 to 25.2 VDC (under rated load current)
Rated output current	4 to 20 mADC
Max. output current	25 mADC (overcurrent protection operation current: approx. 68 mADC)
Allowable conductor resistance	$RL \leq (17.8 - \text{minimum transmitter operation voltage})/0.02 \text{ A}$ where 17.8 V is the result obtained by subtracting the maximum drop voltage of 5 V when the load shunt resistance is 250 Ω from the minimum output voltage of 22.8 V
Max. length of wiring	2 km (when using the CEV cable)
Insulation resistance	20 M Ω or more at 500 VDC between output terminal and ground
Dielectric strength	500 VAC (50/60 Hz, I = 10mA) for one minute between output terminal and ground 500 VAC (50/60 Hz, I = 10mA) for one minute between output terminals

Easy Text Entry (/KB1 and /KB2)

Item	Specifications
Remote control terminal (438227)	
Operating temperature range	0 to 40°C
Operation humidity range	20% to 80% RH (at 5 to 40°C no condensation)
Power supply	3 VDC AA dry batteries \times 2
Weight	Approx. 60 g (excluding the batteries)
External dimensions	170 (H) \times 50 (W) \times 23.7 (D) mm
Signal	Infrared
Combination with the DX	
Number of units that can be controlled individually	Up to 32 units by setting the ID number
Communication distance	Up to 8 m from the front of the light receiving section of the DX (reference value)*
Directional characteristics	See the figure below (reference characteristics)* * Varies depending on the operating environment such as the battery voltage and the presence or absence of external light.
Standard accessories (/KB1)	Remote control unit, two alkaline dry batteries, and ID number label

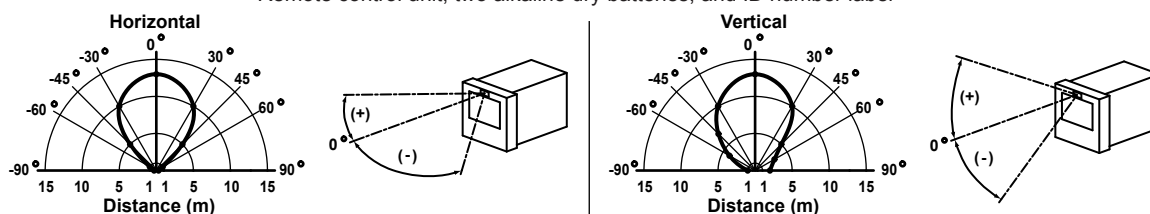

12.5 Options

USB Interface (/USB1)

Item	Specifications
USB port	Complies with Rev. 1.1 and host function
Number of ports	2 (one each on the front panel and rear panel)
Power supply	5 V , 500 mA (per port) Devices which need more than 500 mA total bus power for 2 ports can not be connected at the same time.
Connectable devices	Only connect the devices listed below to prevent damage to the devices.
Keyboard	Complies with HID Class Ver. 1.1 104 keyboard/89 keyboard (US) and 109 keyboard/89 keyboard (Japanese) Number connectable units: 1
External medium	USB flash memory (up to 2 GB) Does not guarantee the operation of all USB flash memories. External medium such as a hard disk, ZIP, MO, and optical discs are not supported. Number connectable units: 1
Barcode reader (release number 3 or later)	USB HID Class Ver. 1.1 compatible English (U.S.) standard USB keyboard compatible

Pulse Input (/PM1)

Item	Specifications
Pulse input	
Number of inputs	3 (8 when using the remote control input terminals)
Input type	Isolated from the main circuitry through a photocoupler and built-in isolated power supply for the input terminals. Shared common for pulse inputs.
Input type and signal level	Voltage-free contact Contact closed at 200 Ω or less and contact open at 100 k Ω or greater Open collector ON voltage: 0.5 V or less (sink current 30 mA or more), leakage current when OFF: 0.25 mA or less
Counting	Counts the rising edges of pulses. For voltage-free contact input: Contact open to contact close For open collector: Voltage level of the terminal H from high to low
Allowable input voltage	30 VDC
Max. sampling pulse period	100 Hz
Minimum detected pulse width	5 ms or more for both low (closed) and high (open)
Pulse detection period	Approx. 3.9 ms (256 Hz)
Pulse measuring accuracy	± 1 pulse
Pulse count interval	Scan interval or 1 s
Miscellaneous	Pulse input terminals can be used as remote control input terminals, isolated from remote control input terminals
Remote control	Number of inputs: 5. Same as remote control (/R1) for the other specifications
Computation function	Same as the computation function (/M1)

Calibration Correction (/CC1)

Item	Specifications
Calibration correction method	Corrects the measured value of each channel using segment linearizer approximation. Number of segment points: 2 to 16 (including the start and end points)
Calibration management	A function to make sure that calibration is performed regularly (release numbers 4 and later)

DC/AC 24 V power supply (/P1)

Item	Specifications
Rated supply voltage	24 VDC and 24 VAC (50/60Hz)
Allowable power supply voltage range	21.6V to 26.4 VDC/AC
Insulation resistance	Between power terminal and earth: 20 MΩ or greater at 500 VDC.
Withstand voltage	Between power terminal and earth: 500 VAC at 50/60 Hz for one minute
Rated power supply frequency (for AC)	50/60 Hz
Allowable power supply frequency range (for AC)	50 Hz ±2%, 60 Hz ±2%
Power supply fluctuation (for AC)	With variation within 21.6 to 26.4 VDC/AC: ±1 digit or less With variation of ±2 Hz from rated power supply frequency (at 24 VAC): ±(0.1% of rdg+1 digit) or less
Rated power consumption	28 VA (for DC), 45 VA (for AC)
Power consumption	

Supply voltage	LCD backlight off	Normal	Maximum
24 VDC	8 VA	15 VA	28 VA
24 VAC (50/60Hz)	15 VA	24 VA	45 VA

Multi batch function (/BT2; release number 3 or later)

Item	Specifications
Function	Individual recording start/stop and file generation operations can be performed for each batch. Equippable models: DX1006, DX1012, DX1006N, and DX1012N
Number of batches	2 to 6
Batch single operations	Recording start/stop, computation reset, message write
Batch overview operations	Computation start/stop, report start/stop, manual sampling, setup data save/load
Scan interval	Maximum speed of 1 s in normal mode only (same for all batches)
Data type	Display or event data only. Trigger mode cannot be used for event data.
Data recording interval	Same for all batches
Data files	Can be displayed or made into an event data file separately for each batch
Number of display groups	Up to six per batch The maximum number of channels per group is six. Channels in a display group are sampled for display or event data.
Timers and match time timers	12 max.
Batch single settings	Group, trip line, file header, data file name, text field, batch number, and lot number

PROFIBUS-DP (/CP1 option; release number 3 or later)

Item	Specifications									
Function	A PROFIBUS-DP master device can access internal data in the following ways: Load measurement channel data Load computation channel data Write to communication input data (for up to 32 channels)									
Data mapping										
	<table border="1"> <thead> <tr> <th>Buffer</th> <th>Description</th> <th>Maximum Size</th> </tr> </thead> <tbody> <tr> <td>Input</td> <td>Measurement channels are arranged at the start of the buffer. As many computation channels as can be placed into the buffer are inserted after the measurement channels.</td> <td>128 bytes</td> </tr> <tr> <td>Output</td> <td>Up to 32 communication input data values are arranged.</td> <td>128 bytes</td> </tr> </tbody> </table>	Buffer	Description	Maximum Size	Input	Measurement channels are arranged at the start of the buffer. As many computation channels as can be placed into the buffer are inserted after the measurement channels.	128 bytes	Output	Up to 32 communication input data values are arranged.	128 bytes
Buffer	Description	Maximum Size								
Input	Measurement channels are arranged at the start of the buffer. As many computation channels as can be placed into the buffer are inserted after the measurement channels.	128 bytes								
Output	Up to 32 communication input data values are arranged.	128 bytes								
Node address	0 to 125									
Interface	PROFIBUS-DP-V0 Slave									
Transmission medium	Two dedicated cables (one for each signal line)									
Transmission speed/distance	9.6 kbps/1200 m to 12 Mbps/100 m									
Terminator	No internal terminator (must be terminated externally)									

12.5 Options

Advanced Security Function (/AS1; release numbers 4 and later)

Item	Specifications
Login function	Only registered users can operate the DX.
Administrators	5 administrators
Users	90 users
User identification	User name, user ID, and password
Password management function	Password management feature that uses Windows Server 2003 or 2008 Active Directory feature Supports login authentication through a Kerberos authentication server
Audit trail function	
Operation log storage	The operation history from the previous memory stop to the current memory stop is attached to a data file. Maximum operation logs: 2000
Change settings log and setup file storage	A setup file and change settings log are saved to the CF card when the settings are changed.
Signature function (digital signature)	Attaches approval information to measured data files.
Information that can be attached	User name, date and time, pass/fail, comment
Number of signatures	Up to 3 per file
Signature record	Can be set for each user
Applicable files	The attached approval information cannot be deleted or changed. Display data files and event data files in the internal memory When the process type is "Batch": Undivided data files (one data file per batch) When the process type is "Continue": Each data file
Measured Data File Protection	Measured data files are protected through operation logs, setup file storage, and encryption.
Data Formats and Extensions	Files that use this function have special extensions. Display data: .DSD, event data: .DSE, setup data: .PEL, change settings log data: .TXT
Miscellaneous (main differences from DXs without the /AS1 option)	
Data types	Display or event data only. Trigger mode cannot be used for event data.
Individual alarm ACK	ACK operations can be performed on individual alarms.
Alarm delay time	Up to 24 h
Event Action	The "PnlLoad" action is not available
Key lock	No
Deletion of external storage medium files	Not allowed.
Formatting of external storage media	Not allowed.
Loading of setup files	You can choose whether or not to load login information.
FAIL/status output relay (/F1 and /F2 options)	You can choose from five operations to assign to the two output relays.
Automatic messages	A message is written when the setting mode setup items are changed during memory sampling.
Logs	There is no login log. There is an operation log and a change settings log.

12.6 General Specifications

Construction

Item	Specifications
Mounting	Flush panel mounting (on a vertical plane) (excluding the desktop type)
Mounting angle	Inclined backward up to 30 degrees from a horizontal plane.
Allowable panel thickness	2 to 26 mm
Material	Case: Metal plate Bezel and display cover: Polycarbonate
Color	Case: Grayish blue green (Munsell 2.0B5.0/1.7 or equivalent) Bezel: Charcoal gray light (Munsell 10B3.6/0.3 or equivalent)
Front panel	Water and dust proof: Complies with IEC529-IP65 and NEMA No.250 TYPE 4 (except External Icing Test) (Style number 2 or later), except side-by-side mounting
External dimensions	144 (W) × 144 (H) × 229 (D) mm (D: depth from the panel mounting plane)
Weight	DX1000: Approx. 2.9 kg excluding options, DX1000N: Approx. 3.7 kg excluding options

Normal Operating Conditions

Item	Specifications
Supply voltage	90 to 132, 180 to 250 VAC
Power supply frequency	50 Hz ± 2%, 60 Hz ± 2%
Ambient temperature	0 to 50°C
Ambient humidity	20 to 80%RH (at 5 to 40°C), 10 to 50% (at 40 to 50°C)
Vibration	10 to 60 Hz, 0.2 m/s ²
Shock	Not allowed
Magnetic field	400 A/m or less (DC and 50/60 Hz)
Noise	Normal mode (50/60 Hz) DC voltage The peak value including the signal must be less than 1.2 times the measuring range. Thermocouple The peak value including the signal must be less than 1.2 times the measuring thermal electromotive force. RTD 50 mV or less Common mode noise 250 VACrms or less for all ranges (50/60 Hz)
Maximum noise voltage between channels	250 VACrms (50/60 Hz) or less
Mounting position	Can be inclined up to 30 degrees backward. Left and right horizontal.
Warm-up time	At least 30 minutes after power on
Installation location	Indoors
Operating altitude	2000 m or less

Power Supply

Item	Specifications												
Rated supply voltage	100 to 240 VAC												
Allowable power supply voltage range	90 to 132, 180 to 264 VAC												
Rated power supply frequency	50 Hz, 60 Hz												
Power consumption	<table border="1"> <thead> <tr> <th>Supply voltage</th> <th>LCD backlight off</th> <th>Normal</th> <th>Maximum</th> </tr> </thead> <tbody> <tr> <td>100 VAC</td> <td>15 VA</td> <td>24 VA</td> <td>45 VA</td> </tr> <tr> <td>240 VAC</td> <td>25 VA</td> <td>32 VA</td> <td>60 VA</td> </tr> </tbody> </table>	Supply voltage	LCD backlight off	Normal	Maximum	100 VAC	15 VA	24 VA	45 VA	240 VAC	25 VA	32 VA	60 VA
Supply voltage	LCD backlight off	Normal	Maximum										
100 VAC	15 VA	24 VA	45 VA										
240 VAC	25 VA	32 VA	60 VA										
Allowable interruption time	Less than 1 cycle of the power supply frequency												

Isolation

Item	Specifications
Insulation resistance	Between the Ethernet, RS-422/485, and insulation terminals and earth: 20 MΩ or greater at 500 VDC
Withstand voltage	Between the power terminal and earth: 2300 VAC at 50/60 Hz for one minute Between the contact output terminal and earth: 1600 VAC at 50/60 Hz for one minute Between the measurement input terminal and earth: 1500 VAC at 50/60 Hz for one minute Mutually between measurement input terminals: 1000 VAC (50/60 Hz) for one minute (excluding the RTD input terminal of DX1006, DX1012, DX1006N and DX1012N) Between the remote input terminal and earth: 1000 VDC for one minute Between the pulse input terminal and earth: 1000 VDC for one minute
Ground	Grounding resistance: 100 Ω or less

12.6 General Specifications

Transport and Storage Conditions

Item	Specifications
Ambient temperature	-25 to 60°C
Ambient humidity	5 to 95%RH (no condensation)
Vibration	10 to 60 Hz, 4.9 m/s ² maximum
Shock	392 m/s ² maximum (in packaged condition)

Supported Standards

Item	Specifications
CSA	CSA22.2 No.61010.1, installation category II ^{*1} , pollution degree 2 ^{*2} , and measurement category II ^{*3}
UL	UL61010-1 (CSA NRTL/C)
CE	
EMC directive	EN61326-1 compliance, Class A Table 2 EN61000-3-2 compliance EN61000-3-3 compliance EN55011 Class A Group 1
Low voltage directive	EN61010-1, installation category II ^{*1} , pollution degree 2 ^{*2} , and measurement category II ^{*3}
C-Tick	EN55011 compliance, Class A Group 1

*1 Installation category (overvoltage category) II: Describes a number which defines a transient overvoltage condition. Implies the regulation for impulse withstand voltage. "II" applies to electrical equipment which is supplied from the fixed installation like a distribution board.

*2 Pollution degree 2: Describes the degree to which a solid, liquid, or gas which deteriorates dielectric strength or surface resistivity is adhering. "2" applies to normal indoor atmosphere. Normally, only non-conductive pollution occurs.

*3 Measurement category II: Applies to measuring circuits connected to low voltage installation, and electrical instruments supplied with power from fixed equipment such as electric switchboards.

Standard Performance

Item	Specifications			
Measurement/display accuracy	Standard operating conditions: Temperature: 23 ± 2°C Humidity: 55% ± 10%RH Power supply voltage: 90 to 132 or 180 to 250 VAC Power supply frequency: 50/60 Hz ± 1% Warm-up time: At least 30 minutes. Other ambient conditions such as vibration should not adversely affect the operation.			
Input Type	Range	Measurement Accuracy (Digital Display)		Max. Resolution of Digital Display
		A/D integration time: 16.7 ms or more	A/D Integration Time: 1.67 ms	
DC voltage	20 mV	±(0.05% of rdg + 12 digits)	±(0.1% of rdg + 40 digits)	1 µV
	60 mV	±(0.05% of rdg + 3 digits)	±(0.1% of rdg + 15 digits)	10 µV
	200 mV			10 µV
	2 V	±(0.05% of rdg + 12 digits)	±(0.1% of rdg + 40 digits)	100 µV
	1-5 V	±(0.05% of rdg + 3 digits)	±(0.1% of rdg + 15 digits)	1 mV
	6 V			1 mV
	20 V			1 mV
	50 V			10 mV
Thermocouple (Not including the accuracy of reference junction compensation; when burnout detection function is off.)	R	±(0.15% of rdg + 1°C)	±(0.2% of rdg + 4°C)	0.1°C
	S	0 to 100°C: ±3.7°C,	0 to 100°C: ±10°C,	
		100 to 300°C: ±1.5°C	100 to 300°C: ±5°C	
	B	400 to 600°C: ±2°C,	400 to 600°C: ±7°C,	
		Accuracy not guaranteed for values less than 400°C.	Accuracy not guaranteed for values less than 400°C.	
	K	±(0.15% of rdg + 0.7°C)	±(0.2% of rdg + 3.5°C)	
	E	-200 to -100°C: ±(0.15% of rdg + 1°C)	-200 to -100°C: ±(0.15% of rdg + 6°C)	
		±(0.15% of rdg + 0.5°C)	±(0.2% of rdg + 2.5°C)	
	J	-200 to -100°C: ±(0.15% of rdg + 0.7°C)	-200 to -100°C: ±(0.2% of rdg + 5°C)	
		±(0.15% of rdg + 0.7°C)	±(0.3% of rdg + 3.5°C)	
	N	-200 to 0°C: ±(0.35% of rdg + 0.7°C)	-200 to 0°C: ±(0.7% of rdg + 3.5°C)	
		Accuracy not guaranteed for values less than -200°C.	Accuracy not guaranteed for values less than -200°C.	
W	±(0.15% of rdg + 1°C)	±(0.3% of rdg + 7°C)		
L	±(0.15% of rdg + 0.5°C)	±(0.2% of rdg + 2.5°C)		
U	-200 to -100°C: ±(0.15% of rdg + 0.7°C)	-200 to -100°C: ±(0.2% of rdg + 5°C)		
WRe	±(0.2% of rdg + 2.5°C)	±(0.3% of rdg + 10°C)		
	0 to 200°C: ±4.0°C	0 to 200°C: ±18.0°C		
RTD	Pt100	±(0.15% of rdg + 0.3°C)	±(0.3% of rdg + 1.5°C)	
	JPt100			
DI	Voltage	Threshold level (Vth=2.4 V) accuracy ± 0.1 V		
	Contact	With parallel capacitance of 0.01 µF or less, 1 kΩ or less: 1 (ON). 100 kΩ or more: 0 (OFF).		

12.6 General Specifications

Item	Specifications
Measuring accuracy in case of scaling	<p>Accuracy during scaling (digits) = measurement accuracy (digits) × multiplier + 2 digits (rounded up)</p> <p>* Fractions rounded up</p> <p>where the multiplier = scaling span (digits)/measuring span (digits).</p> <p>Example For 1-5 V range (A/D integration time is 16.7 ms or more), measurement span of 1.000 to 5.000 V, and scaling span of 0.000 to 2.000</p> <p>The measuring accuracy for 5 V input is as follows.</p> <p>Measuring accuracy (1-5 V range) = $\pm(0.05\% \times 5 \text{ V} + 3 \text{ digits}) = \pm(0.0025 \text{ V} [3 \text{ digits}] + 3 \text{ digits}) = \pm 6 \text{ digits}$</p> <p>Multiplier = $\{2000 \text{ digits (0.000 to 2.000)}\} / 4000 \text{ digits (1.000 to 5.000)} = 0.5$</p> <p>Thus, accuracy during scaling = $\pm(6 \times 0.5 + 2) \text{ digits} = 5 \text{ digits (rounded up)}$</p>
Reference junction compensation accuracy	<p>When measuring temperature greater than or equal to 0 °C and when input terminal temperature is balanced</p> <p>Type R, S, W, WRe: $\pm 1.0^\circ\text{C}$</p> <p>Type K, J, E, T, N, L, and U: $\pm 0.5^\circ\text{C}$. Type B: Internal reference compensation is fixed to 0 °C</p>
Maximum input voltage	$\pm 60 \text{ VDC (continuous)}$
Input resistance	<p>200 mV range or less and TC: 10 MΩ or more</p> <p>2 V range or higher: Approx. 1 MΩ</p>
Input source resistance	
Volt, TC	2 k Ω or less
RTD input	10 Ω or less per wire (The resistance of all three wires must be equal).
Bias current	10 nA or less (except when burnout detection function is enabled)
Maximum common mode noise voltage	250 VACrms (50 Hz/60 Hz)
Maximum noise voltage between channels	250 VACrms (50 Hz/60 Hz)
Interference across channels	120 dB (when the input source resistance is 500 Ω and the input to other channels is 60 VDC)
Common mode rejection ratio	
When the A/D integration time is 20 ms	120 dB (50 Hz $\pm 0.1\%$, 500 Ω unbalanced, between the minus terminal and ground)
When the A/D integration time is 16.7 ms	120 dB (60 Hz $\pm 0.1\%$, 500 Ω unbalanced, between the minus terminal and ground)
When the A/D integration time is 1.67 ms	80 dB or higher (50/60 Hz $\pm 0.1\%$, 500 Ω unbalanced, between the minus terminal and ground)
Normal mode rejection ratio	
When the A/D integration time is 20 ms	40 dB or more (50 Hz $\pm 0.1\%$)
When the A/D integration time is 16.7 ms	40 dB or more (60 Hz $\pm 0.1\%$)
When the A/D integration time is 1.67 ms	Not reject 50/60 Hz

Effects of Operating Conditions

Item	Specifications
Ambient temperature (applies when the A/D integration time is 16.7 ms or greater, with temperature variation of 10 °C)	
DC voltage, TC range	$\pm(0.1\% \text{ of rdg} + 0.05\% \text{ of range})$ or less
RTD range	$\pm(0.1\% \text{ of rdg} + 2 \text{ digits})$ or less
Power supply fluctuation	<p>With variation within 90 to 132 V and 180 to 250 VAC (50/60 Hz):</p> <p>Accuracy specifications are satisfied.</p> <p>With variation of $\pm 2 \text{ Hz}$ from rated power frequency (power supply voltage 100 VAC):</p> <p>Accuracy specifications are satisfied.</p>
Magnetic field	AC (50/60 Hz) and DC 400 A/m fields: $\pm(0.1\% \text{ of rdg} + 10 \text{ digits})$ or less
Input source resistance	
DC voltage range	<p>With variation of +1 kΩ:</p> <p>200 mV range or less: $\pm 10 \mu\text{V}$ or less</p> <p>2 V range or higher: $\pm 0.15\%$ of rdg or less</p>
TC range	With variation of +1 k Ω : $\pm 10 \mu\text{V}$ or less
RTD range (Pt100)	<p>With variation of 10 Ω per wire (resistance of all three wires must be equal): $\pm(0.1\% \text{ of rdg} + 1 \text{ digit})$ or less</p> <p>With maximum difference of 40 mΩ between wires: Approx. 0.1 °C</p>
Effects of vibration	Effects from a sinusoidal vibration along all three axis at a frequency between 10 to 60 Hz and an acceleration of 0.2 m/s ² : $\pm(0.1\% \text{ of rdg} + 1 \text{ digit})$ or less

Miscellaneous

Item	Specifications
Memory backup	A built-in lithium battery backs up the settings and runs the clock Battery life: Approximately 10 years (at room temperature)

12.7 External Dimensions

See the *DX1000/DX1000N Operation Guide (IM04L41B01-02E)*.

Appendix 1 File Size of Display Data and Event Data

This section explains how to calculate the file size of display data files and event data files. The calculation examples are given for the display data only and event data only cases. If you are recording both display and event data, calculate the data size of each and add them together.

Use the calculated file size as a rough guide.

These calculation examples only apply to DXs that do not have the /AS1 advanced security option.

File Size

A file consists of the following data.

Information other than the sampled data + the sampled data

The maximum size of a single display data file or event data file is 8 MB.

Size of Information Other Than the Sampled Data

Item	Size [Bytes]
File header	216
Channel information	$88 \times N + 32$
Group information	$96 \times 10 + 32 = 992$
Message information	$104 \times 50 + 32$ (an add message area is reserved by default)
Batch information	832
Sampled data header	$80 + 32 + N \times 8 + 16 + 2$
Alarm information header	$24 + 8$ (add the size of this item even if there is no alarm)
Message information	Up to 104×1050 (varies depending on the number of messages)
Alarm information	Up to 32×5000 (varies depending on the number of alarms)
Release number 3 expansion information	$1696 + 80 \times N$ Expansion information is always stored.

N is the number of channels (measurement channels + computation channels).

Example 1: If display data of 12 measurement channels and 24 computation channels is recorded. There are no messages or alarms.

$$216 + (88 \times 36 + 32) + 992 + (104 \times 50 + 32) + 832 + (80 + 32 + 36 \times 8 + 16 + 2) + (24 + 8) + 4,576 = 15,498 \text{ bytes}$$

Sampled Data Size

Data Size of Display Data and Event Data

Channel	Display Data	Event Data
Measurement channel	4 bytes/channel	2 bytes/channel
Computation channel	8 bytes/channel	4 bytes/channel

Time data common to all channels is added for each sample.

Time data	8 bytes/sample
-----------	----------------

Data Size per Sample

Display Data

(Number of measurement channels \times 4 bytes) + (number of computation channels \times 8 bytes) + 8 bytes (time data)

Event Data

(Number of measurement channels \times 2 bytes) + (number of computation channels \times 4 bytes) + 8 bytes (time data)

- **Sampled Data Size per File**

Display Data

Data size per sample × file save interval/sampling interval

The sampling interval is determined by dividing the trend interval (in seconds) by 30 (40 if the trend interval is 5 or 10 s).

Example 2: If the display data of 12 measurement channels and 24 computation channels is recorded with a trend interval of 30 min/div (the sampling interval of display data is 60 s) and a file save interval of 1 day (24 h)

$$\begin{aligned} & (12 \times 4 \text{ bytes} + 24 \times 8 \text{ bytes} + 8 \text{ bytes}) \times 24 \text{ h} \times 60 \times 60 / 60 \text{ s} \\ & = 248 \text{ bytes} \times 24 \text{ h} \times 60 \times 60 / 60 \text{ s} \\ & = 357,120 \text{ bytes} \end{aligned}$$

Event Data

Data size per sample × data length/sample rate

Example 3: If the event data of 12 measurement channels and 24 computation channels is recorded with a sample rate of 1 s and data length of 2 h

$$\begin{aligned} & (12 \times 2 \text{ bytes} + 24 \times 4 \text{ bytes} + 8 \text{ bytes}) \times 2 \text{ h} \times 60 \times 60 / 1 \text{ s} \\ & = 128 \text{ bytes} \times 2 \text{ h} \times 60 \times 60 / 1 \text{ s} \\ & = 921,600 \text{ bytes} \end{aligned}$$

Size per File

The size per file is the sum of the size of information other than the sampled data and the size of the sampled data.

Display Data

Example 4: If recording under the conditions of examples 1 and 2

From examples one and two, we obtain $15,498 + 357,120 = 372,618$ bytes = 0.355 MB

Event Data

Example 5: If recording under the conditions of examples 1 and 3

From examples one and three, we obtain $15,498 + 921,600 = 937,098$ bytes = 0.893 MB

Save Duration to the CF Card

We will estimate the duration over which measured data can be saved to a CF card when measured data is being saved automatically.

Display Data

Save duration to the CF card (estimate) = (Size of the CF card/size of a file)×[file save interval]

Example 6: We will estimate the save duration to the CF card under the conditions of examples 1 and 2. In this example, the size of the CF card is assumed to be 256 MB.

$$\begin{aligned} &256 \text{ MB}/0.355 \text{ MB} \times 24 \text{ h} \\ &= 17,307 \text{ h} \\ &= 721 \text{ days} \end{aligned}$$

Event Data

Save duration to the CF card (estimate) = (Size of the CF card/size of a file)×[data length]

Example 7: We will estimate the time until the CF card needs to be replaced under the conditions of examples 1 and 3. In this example, the size of the CF card is assumed to be 256 MB.

$$\begin{aligned} &256 \text{ MB}/0.893 \text{ MB} \times 2 \text{ h} \\ &= 573 \text{ h} \\ &= 23 \text{ days} \end{aligned}$$

Note

If you format a 256-MB CF card, you will be able to use approximately 246 MB.

Time until the Internal Memory Becomes Full

If you are manually saving the measured data in the internal memory, old data is overwritten when the internal memory is full. You must save the measured data to the CF card before the data is overwritten.

Display Data

Time until the internal memory becomes full (estimate) = (Size of the internal memory/size of a file)×[file save interval]

Example 8: We will estimate the time until the internal memory becomes full under the conditions of examples 1 and 2. The size of the internal memory is 400 M bytes.

$$\begin{aligned} &400 \text{ MB}/0.355 \text{ MB} \times 24 \text{ h} \\ &= 27,042 \text{ h} \\ &= 1,126 \text{ days} \end{aligned}$$

Event Data

Time until the internal memory becomes full (estimate) = (Size of the internal memory/size of a file)×[data length]

Example 9: We will estimate the time until the internal memory becomes full under the conditions of examples 1 and 3. The size of the internal memory is 400 M bytes.

$$\begin{aligned} &400 \text{ MB}/0.893 \text{ MB} \times 2 \text{ h} \\ &= 895 \text{ h} \\ &= 37.3 \text{ days} \end{aligned}$$

Appendix 2 Types of Data Files That the DX Can Create and Their Application

This section explains the types of data files that the DX can create and their application.

Data Type	Extension	Format	Display Method ^{*1}		
			DX	DAQ	Application
Display data	DAD	Binary (undisclosed)	Yes	Yes	Yes ^{*2, *3}
	DSD		Yes	Yes	Yes ^{*2, *3}
Event data	DAE	Binary (undisclosed)	Yes	Yes	Yes ^{*2, *3}
	DSE		Yes	Yes	Yes ^{*2, *3}
Report data	DAR	Text (see appendix 3)	-	Yes	Yes
	xml	XML spreadsheet	-	-	Yes
Manual sampled data	DAM	Text (see appendix 3)	-	-	Yes
Setup data	PDL	Binary (undisclosed)	-	-	-
	PEL		-	-	-
Snapshot data	PNG	PNG (general format)	-	-	Yes
Custom display setup data	CDC	Text	-	-	-
Change settings log	TXT	Text	-	-	Yes

*1 DX: DX main unit, DAQ: DAQSTANDARD, Application: Software application

*2 The data format can be converted on DAQSTANDARD and displayed on a software application such as Microsoft Excel.

*3 The data can be retrieved from the DX using the communication function and displayed on a software application.

Appendix 3 Text File Data Format

This section explains the format of text files. The text files that the DX can create are manual sampled data files and report files.

In the explanation below, CRLF represents a terminator.

Format of the Manual Sample Data File

- The manual sampled data is output using numerical values and strings in text format delimited by tabs.
- Values of measurement channels set to **Skip** and computation channels set to **Off** are not output.
- The data is appended to the file each time manual sample operation is performed.

Format

```

YRECCRLF
Manual Sample Data   Version 1.02.00      CRLF
Model                DX1000             CRLF
Language Code       shift-JIS          CRLF
File Status         ffffffff           CRLF
Serial No.          III····I           CRLF
File Header         HHH····H           CRLF
Ch                  ccccc             ccccc      ···      cccccCRLF
Ch Id               ddd····d          ddd····d    ···      ddd····dCRLF
Tag                 ttt····t          ttt····t    ···      ttt····tCRLF
Unit                uuuuuu            uuuuuu      ···      uuuuuuCRLF
yyyy/mo/dd hh:mi:ss nnn····n    nnn····n    ···      nnn····nCRLF
  
```

* Ch Id is only output when Tag numbers are being used, on DXs with release number 3 or later.

fffffff

File status (8 characters)

Complete Completed. (A file with 100 manually sampled data acquisitions that is now complete.)

Progress Data is being added. (An incomplete file that does not yet have 100 manually sampled data acquisitions.)

Decrease The file is defective. (A file that is missing some of the manually sampled data that was stored on it.)

III····I

Serial number of the DX (16 characters)

HHH····H

File header (50 characters)

ccccc

Channel number (5 characters)

ddd····d

Tag number (16 characters)

ttt····t

Tag comment (32 characters)

uuuuuu

Unit (6 characters)

yyyy/mo/dd hh:mi:ss

Sampling year, month, day, and time (19 characters)

nnn····n

Measured value (13 characters)

File Output Example

Below is a manual sample data example of channels 1, 2, 3, and 4.

```

YREC
Manual Sample Data   Version 1.02.00
Model                DX1000
Language Code        shift-JIS
File Status           Progress
Serial No.           S5E701600
File Header
Ch                   CH001      CH002      CH003      CH004
Ch Id                TI-101     OUT-102    FI-103     VA-204
Tag                  abc        def        hij        klmn
Unit                 °C        V          m3/h       %
2005/10/01 08:57:22 213.8     0.517     368.4     68.9
2005/10/01 08:57:28 208.6     0.494     363.0     68.1
    
```

Note

- Output when error data, overrange data, or computation overflow data is detected

Channel	Data	Output
Measurement channels	Error	(Space)
	+over range (includes burnout detection)	99999
	-over range (includes burnout detection)	-99999
Computation channel	Error	999999999
	Positive computation overflow (when the value exceeds 99999999)	999999999
	Negative computation overflow (when the value falls below -99999999)	-999999999
	The decimal place that was specified when the span for the channel was specified applies to the output values. For example, if the span setting of the channel is "200.0," then "999999999" is output when the value exceeds "9999999.9" and "-999999999" is output when the value is below "-999999.9."	

- A new manual sampled data file is created in the following cases.
 - A measurement channel is changed to **Skip** from a range other than **Skip**.
 - A measurement channel is changed from **Skip** to a range other than **Skip**.
 - A computation channel is changed from **On** to **Off** or **Off** to **On**.
 - The unit is changed.

Report File Format

- The hourly, daily, weekly, and monthly reports are output using numeric values and strings in text format delimited by tabs.
- Values of measurement channels set to **Skip** and computation channels set to **Off** are not output.
- The data is appended to this file every time a report is created.

Format

```

YRECCRLF
Report Data      Version 1.02.00      CRLF
Model            DX1000      CRLF
Language Code    shift-JIS  CRLF
File Status      ffffffff  CRLF
Serial No.       III...I     CRLF
File Header      HHH...H     CRLF
Report Set       RRR...R     CRLF
File Data        rrr...r     CRLF
Math Set         MMM      MMM      MMM      MMMCRLF
Start Time       YYYY/MO/DD HH:MI:SS      CRLF
Ch              ccccc      ccccc      ...      cccccCRLF
Ch Id           ddd...d     ddd...d     ...      ddd...dCRLF
Tag            ttt...t     ttt...t     ...      ttt...tCRLF
Unit           uuuuuu     uuuuuu     ...      uuuuuuCRLF
Data Type       sss...s     CRLF
Time            yyyy/mo/dd hh:mi:ss  CRLF
Status          eeeeeeeee  CRLF
Ave             nnn...n     nnn...n     ...      nnn...nCRLF
Max             nnn...n     nnn...n     ...      nnn...nCRLF
Min             nnn...n     nnn...n     ...      nnn...nCRLF
Sum             nnn...n     nnn...n     ...      nnn...nCRLF
    
```

* Ch Id is only output when Tag numbers are being used, on DXs with release number 3 or later.

fffffff

File status (8 characters)

- Complete Completed. (A file with the necessary number of acquisitions for its report type, for example one acquisition for an Hourly report type, that is now complete.)
- Progress Data is being added. (An incomplete file that does not yet have the necessary number of acquisitions for its report type.)
- Decrease The file is defective. (A file that is missing some of the report data that was stored on it.)

III...I

Serial number of the DX (16 characters)

HHH...H

File header (50 characters)

RRR...R

Report setting (setting on the DX) (13 characters)

- Hourly
- Daily
- Hourly+Daily
- Daily+Weekly
- Daily+Monthly

Appendix 3 Text File Data Format

rrr...r	Contents of the report file (13 characters) Hourly Daily Hourly+Daily Daily+Weekly Daily+Monthly Example: When the DX is set to Hourly+Daily and Combine , Hourly+Daily is output. When the DX is set to Hourly+Daily and Separate , the hourly report is output as Hourly , and the daily report as Daily .
MMMM	Report items (16 characters (including tabs that are counted as one character each), up to four types) Ave Max Min Sum Inst Instantaneous value
YYYY/MO/DD HH:MI:SS	Report start year, month, day, and time (19 characters)
ccccc	Channel number (5 characters)
ddd...d	Tag number (16 characters)
ttt...t	Tag comment (32 characters)
uuuuuu	Unit (6 characters)
eeeeeeeeee	Status (output the events that occurred while creating report data) (10 characters) Bo Burn out detected Er Error (error detection) Ov Over (overrange/computation overflow detection) Pw Power failure (power failure occurrence) Cg Change (time change present)
SSS...S	Report type (7 characters) Hourly Daily Weekly Monthly
yyyy/mo/dd hh:mi:ss	Report year, month, day, and time (19 characters)
nnn...n	Average, maximum, minimum, sum, or instantaneous value (13 characters)

File Output Example

Below is an example of an hourly report of 4 channels while creating hourly and daily reports and saving each type of report to a separate file.

```

YREC
Report Data          Version 1.02.00
Model                DX1000
Language Code        shift-JIS
File Status          Complete
Serial No.           S5E701600
File Header
Report Set           Hourly+Daily
File Data            Hourly
Math Set             Ave           Max           Min           Sum
Start Time           2005/10/01 08:10:56
Ch Id                TI-101           OUT-102        FI-103        VA-204
Tag                  abc             def            hij            klmn
Unit                 °C             V              m3/h          %
Data Type            Hourly
Time                 2005/10/01 09:00:00
Status
Ave                  91.5           -0.039        241.1         48.6
Max                  259.8          0.726         416.5         76.6
Min                  -59.9          -0.727        83.4          23.3
Sum                  3.293636E+05  -1.392980E+02 8.680871E+05 1.748983E+05
    
```

Note

- When the channel data is in the condition shown in the table below, the *Er*, *Ov*, or *Bo* status is output to a report.

Data Condition	Status
Error	Er
Measurement channels	
Positive over range	Ov
Negative over range	Ov
Burn out detection	Bo
Computation channels	
Positive computation overflow (when the value exceeds 1.79E + 308)	Ov
Negative computation overflow (when the value falls below -1.79E + 308)	Ov

- The report output value of *Ave*, *Max*, *Min*, *Sum*, and *Inst* varies depending on the channel data condition as shown in the table below.

Item	Data Condition of Measurement Channels	Report Output Value
Ave	When all of the data are errors or over range	(Space)
Max,	• When all of the data are errors	(Space)
Min,	• For +over range (includes burnout detection)	99999
Inst	• For -over range (includes burnout detection)	-99999
Sum	• When all of the data are errors or over range	(Space)
	• When the sum value exceeds approx. 3.4E + 38	9.999999E+99
	• When the sum value is below approx. -3.4E + 38	-9.999999E+99

Item	Data Condition of Computation Channels	Report Output Value
Ave	When all of the data are errors or computation overflow	(Space)
Max,	• When all of the data are errors	(Space)
Min,	• When the maximum value or instantaneous value exceeds 99999999	99999999
Inst	• When the minimum value or instantaneous value is less than -99999999	-99999999
Sum	• When all of the data are errors or computation overflow	(Space)
	• When the sum value exceeds approx. 3.4E + 38	9.999999E+99
	• When the sum value is below approx. -3.4E + 38	-9.999999E+99

* The decimal place that was specified when the span for the channel was specified applies to the maximum and minimum values or the instantaneous values. For example, if the span setting of the channel is "200.0," then "99999999" is output when the value exceeds "9999999.9" and "-99999999" is output when the value is below "-9999999.9."

Format of the Change Settings Log (/AS1 option)

- The change settings log is output as a tab-separated text file.
- Each time a report is created, data is added to the file.

Format

```
YRECCRLF
Setting Change Data Version 1.00.00CRLF
File Status          ffffffffCRLF
Serial No.           III•••ICRLF
Changed              yyyy/mo/dd hh:mi:ssCRLF
Contents             ccc•••cCRLF
File Info            ddd•••d nnn•••nCRLF
User Info            ppp•••p ttt•••t uuu•••uCRLF
```

fffffff	File status (8 characters)
Complete	Completed (A file with 100 change settings log entries that is now complete.)
Progress	Data is being added. (An incomplete file that does not yet have 100 change settings log entries.)
III•••I	Serial number (up to 16 characters)
yyyy/mo/dd hh:mi:ss	Year, month, day, and time when the setting change was executed (19 characters)
ccc•••c	The following are connected with pluses (16 characters).
Eng	Changing of setting mode settings
Sys	Changing of basic setting mode settings
Login	Changing of login information
ddd•••d	File serial number (10 characters)
nnn•••n	File name (12 characters)
ppp•••p	Type of setting change (10 characters)
Manual	Settings changed by the user
ttt•••t	Input method (8 characters)
Key	Settings changed by the user
Communication	Settings changed by the user
uuu•••u	User name (20 characters)

Appendix 3 Text File Data Format

File Output Example

Below is an example of a change settings log file with two change settings log entries.

```
YREC
Setting Change Data Version 1.00.00
File Status      Progress
Serial No.       S5H907377
Changed          2010/04/01 00:55:44
Contents         Sys
File Info        209 40100550.PEL
User Info        Manual KEY
Changed          2010/04/02 00:56:18
Contents         Login
File Info        210      40100560.PEL
User Info        Manual    KEY      Admin1
```

Index

Symbol

**	9-6
+Over	1-15
-Over	1-15
[a?b:c]	9-10
24 VDC transmitter power supply	12-15
24 V power supply	12-17
3 leg isolated RTD input	12-14

A

A/D integration time	3-1
ABS	9-6
absolute time	4-19
absolute time mode	1-38
action	1-39
added messages	1-17
administrator	1-43, 8-5
advanced security function	1-56, 12-18
advanced security option	1-40
alarm	1-4, 12-2
alarm ACK	1-7, 3-15
alarm acknowledge	1-7
alarm acknowledge operation	3-15
alarm annunciator	1-8, 3-21
alarm colors	1-5
alarm delay time	3-14, 9-3
alarm hide function	1-5
alarm indication	1-5
alarm levels	1-5
alarm mark indication	5-15
alarm output relay	1-6, 3-8, 12-11
alarm settings	3-11
alarm summary	1-20, 4-28
alarm value	3-13
all channel	4-17
all channel display	4-6, 4-17
all data display	4-13
AND	9-7
AND/OR	1-6
annunciator display	3-23
annunciator sequence	3-21, 3-25
annunciator windows	3-23
auto increment	6-7
auto logout	1-43, 8-4, 8-6
automatic message writing	1-12
auto save	1-31, 6-5
auto scroll	4-6
auto span	4-20
auto span display	1-18
auto zone	1-13, 4-6, 4-17

B

background color	1-25, 5-23
background color (historical trend)	4-21
backlight saver	1-25, 2-8
barcode reader	2-22
bar graph display	1-16, 4-4
base position (bar graphs)	5-20
basic setting mode	2-27
batch comment	1-36, 6-7
batch function	6-7, 12-10
batch name	6-7

brightness	1-25, 2-8
burnout	1-15, 3-2
burnout Detection	1-2

C

calculate the file size	App-1
calendar	4-16
calibration	11-2
calibration correction	1-3, 3-16, 12-16
calibration due date	3-32
calibration management	1-3
calibration notification screen	3-31
CARRY	9-10
change message	5-5
change settings log	4-39, 12-7
changing settings during recording	6-13
channel (computation)	1-44
channel display colors	5-10
channel number	5-3
clamped input terminal	12-11
CLOG computation	9-9
color scale band	5-16
comma	2-26
comment text block	5-34
comment text field	5-34
communication application errors	10-9
communication errors	10-15
communication functions	12-10
communication log	4-36
computation channel	9-1
computation data dropout	1-47, 9-15
computation error	9-4
computation function	1-44, 12-12
computation types	1-44
conditional expression	9-10
configuration (storage)	12-6
construction (DX)	12-19
continuing data	4-12
count (moving average)	3-6
Cu10, Cu25 RTD input	12-13
current value display	5-14
cursor (historical trend)	4-12
cursor time	4-19
custom display	1-56
custom display setup data	1-35, 12-8
customizing the display selection menus	5-29
customizing the FUNC key menus	5-29
customizing the menus	1-24, 4-3

D

data display section	1-9
data file loading	12-8
data files that the DX can create	App-4
data kind	6-2
data length	6-3
data save mode	2-24, 4-33
data that can be used in equations	1-46
data type	12-6
data types	1-26
date/time	2-1
date format	1-54, 2-4
de-energize	1-7
decimal point type	2-26

Index

delay high limit alarm 1-4
delay low limit alarm 1-4
deleting a file 6-17
desktop type 12-12
detect (alarm hide function) 3-14
DHCP log 4-38
difference computation 1-3
difference lower limit alarm 1-4
difference upper limit alarm 1-4
digit (scale value) 5-14
digital display 1-15, 4-4
directory (data save) 1-31
display (LCD) 12-3
display color (channels) 5-10
display color (messages) 5-9
display comments 5-33
display data 1-261-56, 1-28, 12-6
display direction (bar graphs) 5-20
display direction (messages) 5-19
display direction (trend) 5-19
displayed information 12-3
displayed language 1-55
display group 5-1
display menu 4-1, 5-31
display positions 3-24
display selection menu 4-1, 5-31
display window 3-24
display zone 5-11
divided (report file) 9-17
division (scale) 5-13
DST (daylight saving time) 1-54, 2-1

E

e-mail log 4-37
easy text entry 1-55, 12-15
effects of operating conditions 12-22
energize 1-7
EQ 9-6
error codes 10-1
error data 1-50
error log 4-36
error messages 10-1
errors related to parameter settings 10-1
event 1-37
event action 1-37, 7-1, 12-9
event data 1-26, 1-28, 12-6
event level switch status 1-24
event level switch status display 4-27
EXP 9-6
expressions (computation) 9-5
extended input type 12-14
extension (file) 1-33
external dimensions 12-24
external storage medium 1-31

F

FAIL/status output relay 12-11
FAIL output 1-52, 2-13
fast sampling mode 1-1
favorite key 1-24, 5-26
file header 6-5
file name 1-33
file size App-1
fine grid 4-6, 4-18
firmware version 2-5
first weekday 4-16
fixed (alarm mark) 5-15
flag 1-46

flow of data recording and storage 1-27
format of the change settings log App-11
formatting 6-17
format type 6-17
four arithmetic operation 9-6
free (event data) 1-29, 6-3
free messages 1-12, 5-9
free space 6-17
FTP log 4-36
FUNC key menu 4-2, 5-30

G

GE 9-6
gradually correcting the internal clock 1-54
graph display 1-9
grid 5-19
groups 5-1
group set 5-1
GT 9-6

H

historical trend display 1-17, 4-9
HOLD 9-10
hold (alarm indication) 1-5
hold (alarm output relay) 1-7
hysteresis 1-4, 3-9

I

identified strings 6-5
ID number 2-15
indicator 3-8
individual alarm ACK operation 4-23
information on the displayed measured data 4-21
initialize 2-10
inner instrument 11-4
input calibration interval 3-30
input processing 1-2
input range 3-3
input type 1-1, 3-4
integration time 1-1
internal memory 1-27
internal switch 1-7, 1-37, 3-8
interval (rate-of-change alarm) 1-4, 3-7
invalid keys 2-21
invalid user relay 1-52
ISA-A 3-27
ISA-A-4 3-25
ISA-M 3-29
isolation 12-19

J

jump default display 5-25

K

keyboard 2-20
key lock 1-42, 8-1
keywords 9-20

L

LE 9-6
limitations (expressions) 9-5
linear scaling 1-3
line width of the trend 5-19
list of files 6-16
LN 9-6
loading a file 6-18

loading a template file.....	6-22
loading setup data.....	6-21
LOG.....	9-6
log display.....	1-24
logging in.....	8-6
logging out.....	8-6
logical computation.....	9-7
login function.....	1-43, 8-4
login log.....	4-35
log into the DX.....	8-6
lot-No. digit.....	6-7
lot number.....	1-36
low-cut.....	1-3, 3-5
LT.....	9-6

M

MAC address.....	2-5
maintenance.....	11-1
maintenance and test communication command errors.....	10-15
manuals.....	i
manual sampled data.....	1-26, 1-30, 6-14, 12-7
manual sampled data (format).....	App-5
manual save.....	1-32
match time timer.....	1-37, 7-4
math start action.....	9-14
measurement channel.....	1-1
measurement input.....	12-1
measure soft key.....	3-16
media FIFO.....	1-32, 6-5
memory backup.....	12-23
memory sample.....	6-2
memory sample relay.....	1-52
memory start.....	6-10
memory stop.....	6-11
memory summary.....	1-22, 4-32
message colors.....	5-9
message display.....	4-6, 4-19
message display methods.....	4-31
messages.....	1-12, 5-7
messages (errors, status, etc).....	10-1
message summary.....	1-21, 4-30
modbus client status display.....	1-24
modbus master status display.....	1-24
modbus status display.....	4-26
modbus status log.....	4-38
mode (input range).....	3-4
moving average.....	1-2, 3-6
multi batch function.....	1-56, 12-17

N

NE.....	9-6
network information.....	2-5
next soft key.....	4-2
No logging.....	3-10
non-hold (alarm indication).....	1-5
non-hold (alarm output relay).....	1-7
normal operating conditions.....	12-19
NOT.....	9-7
number of pulses per minute.....	3-18
numeric display.....	1-15, 4-6

O

operating event switches.....	7-5
operation errors.....	10-7
operation log.....	4-39
operation logs.....	4-35
operations that can be carried out when logged out.....	1-43

OR.....	9-7
order of precedence (computation).....	9-5
overflow data.....	1-50, 9-4
overview display.....	1-19, 4-22

P

parameters.....	9-22
partial expanded display.....	1-14, 5-17
parts replacement.....	11-1
password (login function).....	8-5
password change.....	8-7
point.....	2-26
power-fail message.....	5-28
power computations.....	9-6
power failure operation.....	1-50
power supply.....	12-19
power supply for transmitter.....	1-55
PRE.....	9-10
pre-trigger.....	6-3
preset display.....	5-25
pretrigger.....	1-29
processing order of computation.....	1-46
PROFIBUS-DP.....	12-17
progress of the save operation.....	4-34
pulse input.....	1-3, 12-16
pulse sum value.....	3-17

R

range (input range).....	3-4
rate-of-change alarm.....	1-4
recommended replacement periods for worn parts.....	11-1
recording conditions (display data).....	1-28
recording conditions (event data).....	1-29
ref. CH.....	3-5
reference channel.....	3-5
reference junction compensation.....	1-2, 3-2
refresh.....	1-6, 3-7
relational computation.....	9-6
relative time.....	4-19
relative time mode.....	1-38
relay action.....	2-12
Relay Action on Ack.....	3-9
relay status display.....	1-24, 4-26
release number.....	iii
releasing the key lock.....	8-2
remote contact input operation.....	7-10
remote control (/R1).....	12-15
remote control function.....	1-37, 7-1
remote controller ID.....	2-5, 2-14
remote control terminal.....	2-15
repeat (event data).....	1-29
report.....	9-16
report channel.....	9-18
report data.....	1-23, 1-26, 1-30, 12-7
report data keyword examples.....	9-23
report data keywords.....	9-21
report display.....	4-25
report file (format).....	App-7
report function.....	1-49
report group.....	9-18
report template.....	1-51, 6-24, 9-19
RESET.....	9-10
reset (TLOG).....	1-48
resets the computed result (Rst+St).....	9-14
reset the sum value.....	3-18
resetting the computed results.....	9-15
resetting the match time timer.....	7-6
resetting the relative timer.....	7-5, 7-6

Index

revisions ii
rolling average 1-47, 9-4
RS-232 interface 12-11
RS-422A/485 interface 12-11

S

sample rate 6-3
save directory 6-5
save duration to the CF card App-3
save interval 6-2
saving a template file 6-23
saving data to the external storage medium 1-31
saving measured data (automatically) 6-10
saving measured data (manually) 6-11
saving setup data 6-19
saving the data 4-33
scale 4-6, 4-17, 5-12
scale lower 3-5
scan interval 1-1, 3-1
screen image data 1-26, 6-15
scroll time 5-24
search for measured data 4-14
secondary interval 5-6
security 8-4
security function 12-9
selecting a bar 4-42
separators 5-30
setup data 1-26, 1-35, 12-7
single (event data) 1-29
single/dual graph display 4-41
snapshot 6-15, 12-7
snapshot data 1-26, 1-35
SNTP log 4-38
sort item 4-28, 4-31
span lower 3-5
Special computation 9-10
special data 1-50
special keywords 9-21
SQR 9-6
square root computation 1-3
stacked bar graph 1-23, 4-40
standard display soft key 5-25
standard performance 12-21
standards 12-20
standard temperature device 11-2
starting the computation 9-14
start the recording 6-10
status display section 1-10
status messages 10-17
status output 1-53, 2-11
status relay 2-13
stopping the recording 6-11
structure of the file name 6-5
style number iii
sub menu 4-1, 5-31
sum scale 1-49
symbols that can be entered 2-20
system display 1-55
system errors 10-19
system information 2-5
system keyword examples 9-23
system keywords 9-21

T

tag 5-3
tag comment 5-4
tag detail 4-7, 4-18, 4-24, 4-29
tag display 4-1

tag no. use/not 5-4
tag number 5-4
temperature unit 1-56, 3-3
template-based report file 1-51
text field 1-36, 6-7, 6-9
text file data format App-5
time at the grid position 2-4, 5-6
time axis 4-20
time correction operation 1-54
time deviation limit 2-3
timer 1-38, 7-4
timer action 7-5
time related functions 12-9
time set 2-1
time until the internal memory becomes full App-3
time zone 1-54, 2-2
TLOG 9-3
TLOG computation 1-47, 9-8
top channel 4-20
top channel display 1-18
trademarks ii
transport and storage conditions 12-20
trend display 4-4
trend display (T-Y) 1-11
trend history 4-9
trend interval 1-12, 5-5, 6-2
trend rate switching 5-5
trend sapce 4-8
trigger 6-10
trigger signal 6-3
trip line 5-2
troubleshooting 10-20
types of characters 12-9

U

unit in computations 1-46
unsaved data 1-32
update interval (measured values) 1-9
updating of the waveform 1-12
USB interface 1-56, 12-16
user 1-43, 8-5
USER key 1-37, 7-1
user login status relay 1-52

V

value indicator 5-14
value on over-range 3-20

W

warning messages 10-19
web log 4-37

X

XOR 9-7

Z

zone display 1-13