

DPR100 C/D

PEN AND MULTIPOINT 100 mm DIGITAL RECORDERS

EN01-6021 March 2010

PRODUCT SPECIFICATION SHEET

PRODUCT DESCRIPTION

The DPR 100 C and D recorders are designed to meet the recording needs for most recording applications. They provide clear and easy to understand charts, full chart documentation and a wide choice of ranges and actuations that allows the user to document the process and what has occurred.

The two versions are:

DPR 100C: 1 to 3 continuous pen
DPR 100D: 3 or 6 channel multipoint.

Their large bright display, together with their outstanding chart visibility and fluorescent illumination makes it easy to read and interpret from a considerable distance.

They are particularly suitable for chemicals, pharmaceuticals, power generation, metals, environmental monitoring and food processing applications.



DPR100 C
1 to 3 continuous pens



DPR100 D
3 or 6 channel multipoint

MAIN FEATURES

- 100 mm chart width (DIN 16230).
- 0.1 % accuracy full scale (IEC 873) applicable on a very wide choice of actuations and of ranges.
- Each input span is adjustable within the selected range, with up to 2 ranges per channel.
- Universal input board (T/C, RTD, mV, mA).
- Alphanumeric display: 12 digits or bargraphs, adjustable brightness.
- Roll or fan fold chart.
- Fully documented chart with trace colour assignment, alarm trend in red, tagging, zooming, zoning, trend or tabular print outs, Messages for all inputs up to 500 mm/h.
- Up to 10 traces (6 analogue, 4 digital inputs) on the multipoint DPR 100D
- Permanent operation up to 50°C (120°F) with fanfold, 60 °C (140°F) with chart roll.
- Full configurability thru: front keys and interactive program menu in 6 languages as standard, Optional: by Honeywell supplied PC software connected via the front jack, or by communication, with multilevel password security.
- 12 user configurable messages alarms or recorder events.
- 4 lines batch header automatically incremented and saved in case of power failure.
- Event precursor mode.
- Firmware upgrades via the front jack .
- Input calibration traceability (audit-trail).
- 12 alarm set points, assignable to any input, math result, comm signal.
- 2 configurable chart speeds, selectable via alarm, logic input, front keys and communication.
- Universal power supply 85 to 264 VAC 50/60 Hz, 24 or 48 AC/DC
- IP 54 front protection (IEC 529).
- Compact dimensions:
 - 144 x 144mm x 245mm (5.67" x 5.67" x 9.7")

OPTIONS

- Up to 12 relay outputs assignable to (14 characters each).
- Up to 4 logic inputs.
- Mathematic packages, with the results saved in case of power failure. Math functions can be interconnected.
- 24 VDC transmitter power supply.
- Communication: ASCII, MODBUS RTU
- CSA approved. UL Listed.
- 2 Current output 4 to 20 mA option configurable on Analog Inputs, Maths or Communication.

The best chart in the industry

With the roll chart, more than 90mm of of chart is visible at any time. When fan fold paper is used, up to 80mm of chart is visible

Pen

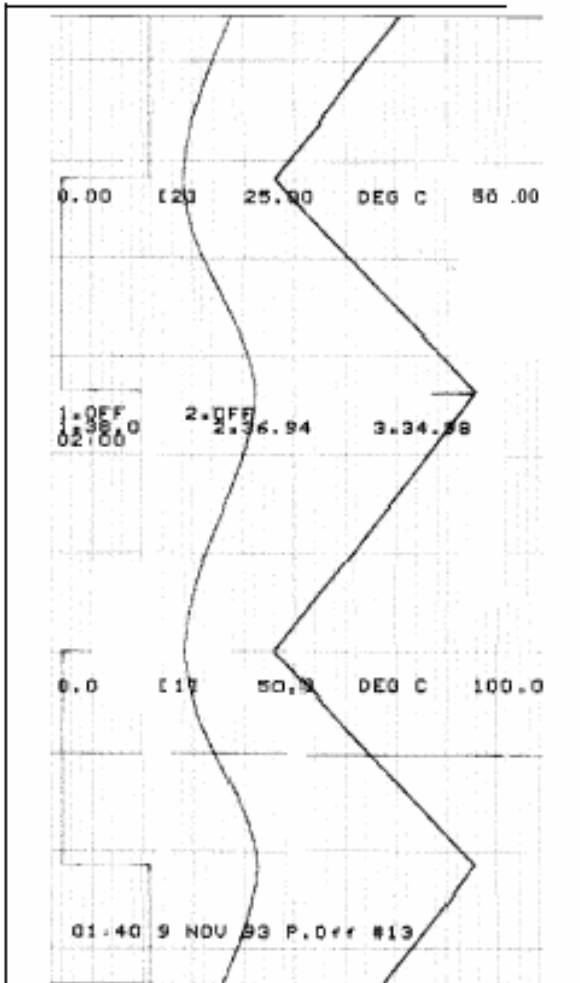

Alarms are indicated clearly.

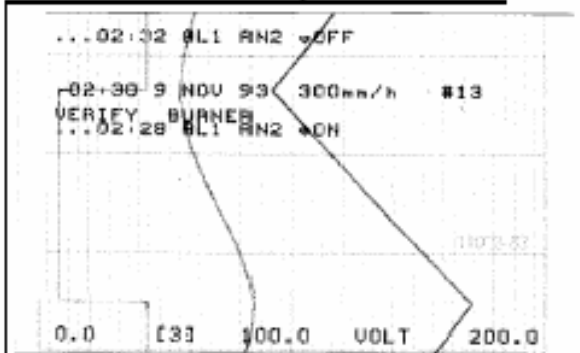

Multipoint

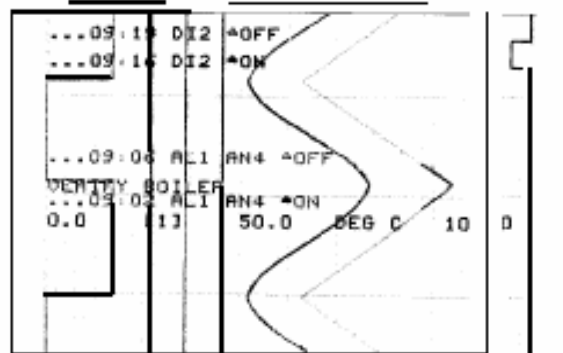
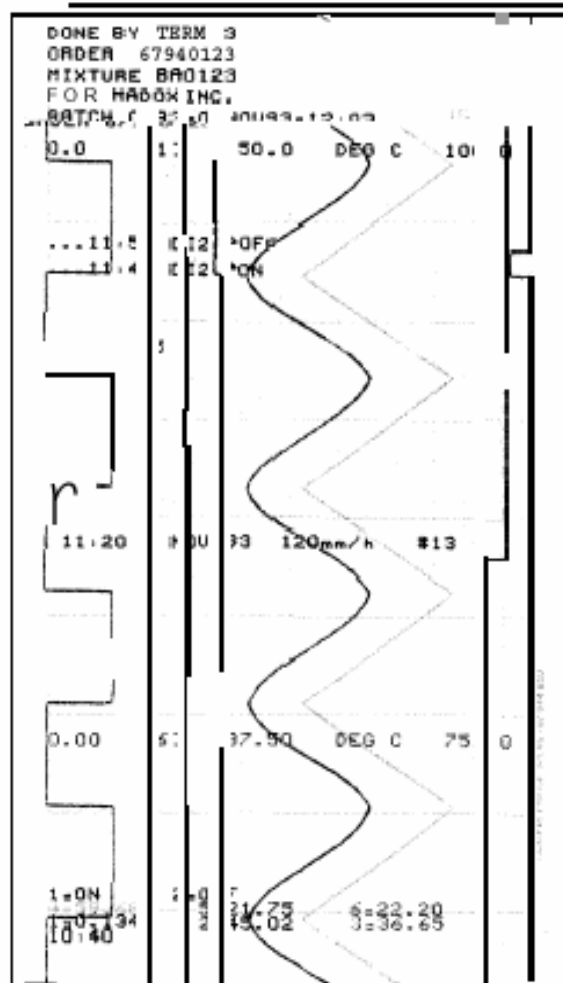

DPR100 C Pen Recorder: Writing Speed

Chart Speed		Chart documentation
Up to 700 mm/hr	Up to 28 in/hr	Chart fully documented
700 to 1000 mm/hr	28 to 40 in/hr	Alarm messages but no chart scales
1000 to 6000 mm/hr	40 to 240 in/hr	Traces only

DPR100 D Multipoint Recorder: Writing Speed

#Inputs (See Note 1)	Continuous traces in colour with full chart documentation mm/hr (in/hr)	Dotted traces in colour with full chart documentation	Dotted traces in colour without chart range markings. Alarm messages are printed.
1	10 to 1200 (0.5 to 48)	-	1200 to 1500 (48 to 60)
2	10 to 925 (0.5 to 37)	925 to 1000 (37 to 40)	1000 TO 1500 (40 TO 60)
3	10 to 775 (0.5 to 31)	775 to 1000 (31 to 40)	1000 TO 1500 (40 TO 60)
4	10 to 650 (0.5 to 26)	650 to 1000 (26 to 40)	1000 TO 1500 (40 TO 60)
5	10 to 550 (0.5 to 22)	550 to 1000 (22 to 40)	1000 TO 1500 (40 TO 60)
6	10 to 475 (0.5 to 19)	475 to 1000 (19 to 40)	1000 TO 1500 (40 TO 60)
7	10 to 400 (0.5 to 16)	400 to 1000 (16 to 40)	1000 TO 1500 (40 TO 60)
8	10 to 350 (0.5 to 14)	350 to 1000 (14 to 40)	1000 TO 1500 (40 TO 60)

Note: Number of traces: up to 6 analogue inputs and 4 digital event traces.

Front Configuration

A user friendly program with local language prompts (English, French, German, Italian, Spanish and Swedish) permits a full configuration of the recorder using the 6 front keys.

A Multi level password protects against unauthorized changes to the configuration. 2 different product configurations can be stored in the memory.

PC Configuration

Via the front communications jack the recorder can be configured from a personal computer using an optional PC interface module. In addition to the configuration, the PC will provide the ability to upload, download, modify, store the recorder configuration, initiate diagnostic test and provides the facility to linearise up to 2 customised input sensors (50 segments each).

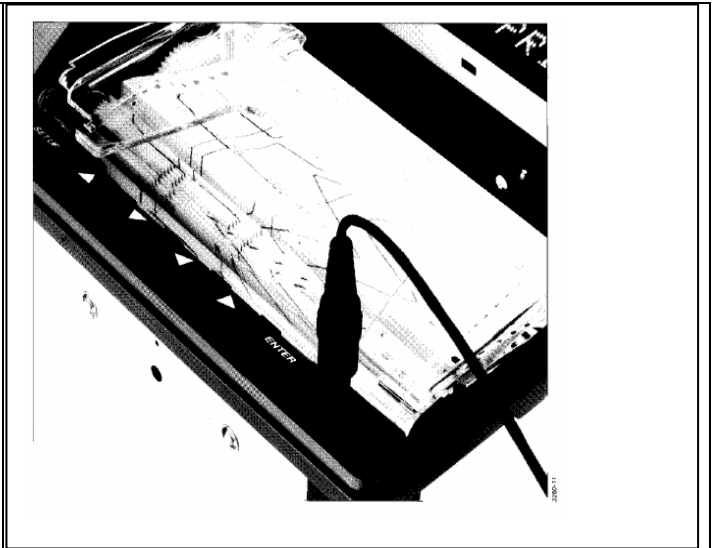

The DPR 100's compact, modular design and rugged construction reduces spare parts inventory and simplifies maintenance. Its operator-friendly configuration keys, easy to read digital displays, reliable alarm functions and customised charts ensure accurate monitoring and recording of your process.

- 1. IP54 door
- 2. Process data is clearly displayed on a large digital display. A 12 digit or bargraph display gives precise values that are visible up to 5 meters from the recorder.
- 3. The compact pen carriage module and high quality servo-motor chart drive ensure reliable operation of the pen carriage and printing mechanism. The ink cartridge and print wheel module are easily removed for quick replacement

- 8. The plug-in terminal blocks allow easy maintenance.
- 7. The universal power supply accepts virtually any AC or DC voltage.
- 6. The universal input card module with 2 logic and 3 analogue inputs reduces configuration time.

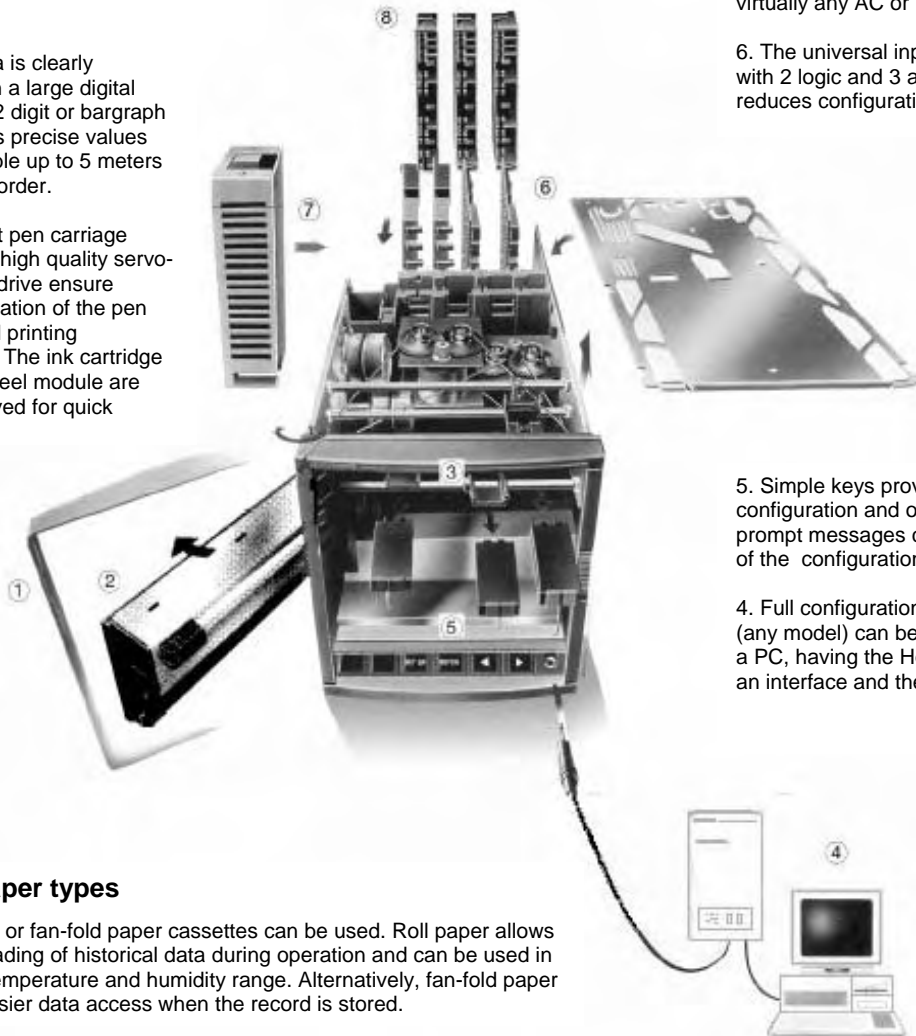

- 5. Simple keys provide easy configuration and operation. Interactive prompt messages confirm modification of the configuration or function.
- 4. Full configuration of the DPR 100 (any model) can be performed from a PC, having the Honeywell Software, an interface and the front jack.

Two paper types

Either roll or fan-fold paper cassettes can be used. Roll paper allows easier reading of historical data during operation and can be used in a wider temperature and humidity range. Alternatively, fan-fold paper allows easier data access when the record is stored.

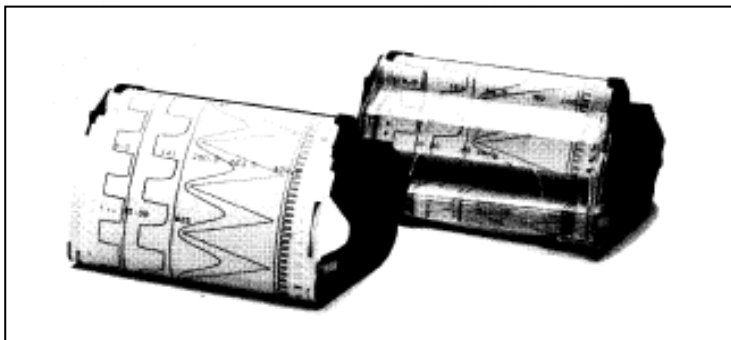

DPR 100 FUNCTIONAL SPECIFICATIONS

Technical data	DPR100 C/D
Technology	Microprocessor based, with non-volatile memory. Flash memory for software upgrade via the front jack.
Analogue inputs DPR 100C pen recorder DPR 100D multipoint recorder Signal source Basic mathematics functions Filter Field calibration Burnout Scanning time (solid state relays) Input impedance Stray rejection	1, 2 or 3 continuous traces. 3 or 6 channels. Inputs are scanned by solid state switches and are galvanically isolated (except for RTD sensor). Thermocouple with individual cold junction compensation. Line resistance up to 1000 ohms T/C, mV, mA, V. RTD Pt 100 3-wire connections, lead resistance per wire 40 ohms balanced. Square Root extraction ($\sqrt{\quad}$) Differential = (ΔT). A digital filter is configurable per input, 0 to 99 seconds. A channel field calibration - 0% and 100% span - may be made to certify input sensor loop. T/C, mV, Volt, configurable to upscale, to downscale or none. RTD: inherent upscale, mA: inherent downscale. Pen: 1 pen = 160 ms 2 pens = 240 ms 3 pens = 330 ms Mpt: 3 channels = 330 ms / 6 channels = 640 ms. 10 Mohm for T/C, mV inputs. >1 Mohm for volt inputs. Series mode 60 db, Common mode at 250 Vac 130 db (in t/c inputs config.).
Display Brightness	12 digit fluorescent display: 8.5 mm (0.33") high (matrix display) configurable in: - digital PV values with engineering unit in accordance with the input range -1 or 2 bargraphs Can display analogue input, Tags, math results, communication, alarms or event messages. The display brightness is configurable.
Recording span Scaling Zoning Pen offset (Pen recorder) Pen cartiage speed	Per input, up to 2 analogue scales can be configured to be printed on the chart with the engineering unit channel reference and tag name, Each input can be configured differently. Each input can be configured on 0 to 100%, or 0 to 50%, or 50 to 100% of the chart. Distance between pen: 2 mm (0.08") - Offset compensation configurable. Chart definition: 1 step = 0.2 mm (0.008"). 1 second full scale.
Chart length	Fan-fold 18m (59ft) (as DIN 16230)/ Roll 24m (79ft).
Chart speed Speed setting Stepping chart motor	1 or 2 chart speeds, fully configurable, selected by a logic input, alarm or configuration. Speed 1: fully adjustable per step of 1 mm/h, within limit Speed 2: fully adjustable per step of 1 mm/h, within limit Pen: 1 to 6000 mm/h (0.04 to 240"/h), Mpt: 1 to 1500 mm/h (0,04 to 60"/h). Continuous traces in color, dotted traces in configurable color with regular chart documentation (configurable). Resolution 0,12 mm.
Product configuration Front configuration PC configuration	<ul style="list-style-type: none"> 2 product configurations can be stored and selected by the front keys. A very simple and interactive product configuration can be carried out on the product with 6 front keys. A friendly program with prompt messages confirms the operation. The prompt messages can be selected in different languages: English, German, French, Spanish, Italian or Swedish. A 2-level password protects the unit from non-authorized modification (level 1 = limited access; level 2 = full protection). Through the front jack the unit can be configured from a PC through a PC interface. This provides the facility to copy the configuration, modify, store, upload or download the product configuration or make a service diagnostic or upgrade a new software or linearize 2 special customer sensors (50 segments each).

<p>Logic inputs Actions</p>	<p>Up to 4 dry contact inputs (1.5 mA - 12 V DC). Change chart speed 1 to speed 2, tab interval 1 to tab interval 2, digital print-out, print message, print inhibit, event trace, print a batch message, tabulate maths calculations. Event marking: Pen: Pen 1 used as operation marker on the right side of the chart for event 1 and on the left side of the chart for event 2. Mpt: 4 traces maximum on the chart. The trace position and the color are configurable.</p>
<p>Alarms Set-point Function Output</p>	<p>12 alarm set-points, freely assignable to any channel and output relay Full configurability of set-point, hysteresis and alarm type (high, low, rate of change, deviation). Can trigger a message, print channel red in alarm, print in alarm, change the range, change the speed, print digital PV values, trigger the event precursor. 2, or 6, or 12 SPST relay outputs: 2 A, 250 V AC on resistive load. Contact N.C. in alarm condition (configurable in N.O.)</p>
<p>Alphanumeric documentation Messages Batch header Process variable Tag name</p>	<p>12 freely assignable and configurable messages of 14 characters each, including the specific letters used in GE & SW. Can be printed with the date/time on top of the traces by alarms, logic inputs or communication. One batch message of 4 lines of 14 characters, fully configurable, with incremented batch numbers and date/time. Printed through digital input and saved upon power interruption. The traces can be assigned to analogue input, mathematics calculations or communication inputs, and are printed in channel color. Periodic digital printing at intervals configurable from 60 to 480 mm (2.36" to 18.9"). Digital print-out of PV values through alarms, digital inputs, communication or front keyboard. Each channel can be named by 8 characters.</p>
<p>Event precursor Stand-by Downloading</p>	<p>The acquisition data is stored in a buffer memory (FiFo) A stand-by message is periodically printed. On event (alarm, digital input, front key, communication) the data is downloaded to be printed on the chart at pre-configured speed. The history before and after the event represents about 50 mm of chart paper.</p>
<p>Mathematics package (optional)</p>	<p>Many functions are available such as:</p> <ul style="list-style-type: none"> - Basic mathematics functions - Fo sterilization - Mass flows - Vacuum pressure - Min, max - Square root - Totalization - Energy consumption - Averages - Timers - Carbon Potential <p>The maths calculations and results are stored during power interruptions.</p>
<p>Digital communication (optional) Protocols PC Supervision Autodial</p>	<p>RS232 ASCII communication to PC application. RS422 or RS485 ASCII Communication output. RS422 or RS485 Modbus RTU communication output. Through ASCII communication, application software gives the facility to read PVs, alarms or event status, to store the information on a file, to send a message to the recorder or to modify the product configuration. The RS232 ASCII communication can dial automatically a phone number of a remote station to send via Modem an Alarm message or a periodic Report. Note: Dialing out via modem autodial can affect data over communications as it uses the same communications port.</p>
<p>Event</p>	<p>The recorder can be configured to deliver an output signal (alarm relay) on a recorder event such as burnout, paper cassette out, battery fail, alarm condition or communication interrupted.</p>
<p>Current output (optional)</p>	<p>2 Current output signals 4 to 20 mA. Configurable on - Analogue Inputs, Mathematics Calculations, or Communication Signals Base Load Resistor 400 ohms.</p>
<p>Power supply To transmitters Power consumption</p>	<p>100 to 240 V AC/DC or 24 or 48 VAC/DC (+10-15% nominal) 24 V, 50 mA typical, 75 mA maximum mA 3 pens & Mpt: 55 VA max. (Active power 30w)</p>

Technical data**DPR100 C/D**

Clock timer Format Power interruption Accuracy	Year, month, hour, minute can be set Battery backed (10 years time, 3 years off power) $\pm 10^{-5}$
Packaging Weight Front face Depth Front window Front protection Lock Construction Chart illumination Option	Pen & Mpt: 3.5 kg (7.7lb) 144 x 144 mm (5.67" x 5.67") according to DIN 43718 245 mm /9.7" behind panel, including terminals and line protection cover Polycarbonate IP 54 (IEC 529) Latch or key (DIN 43832-N) Silicon-free Fluorescent light Rear terminal cover, portable case
Mounting	Panel mounting $\pm 30^\circ$ from horizontal.
Wiring	Rear screw terminals, Terminal modules plug onto the instrument boards.
Writing Pen Multipoint	1 cartridge per pen, fiber tip, 1400 m (4593ft) of trace per color (blue, red, green) 1 print wheel, 6 colors, 250 m (820ft) of trace per color (purple, red, black, green, blue, brown)
Noise immunity	This product is in conformity with the protection requirements of the following European Council Directives: <ul style="list-style-type: none"> 73/23/EEC, the Low Voltage Directive and 89/336/EEC, the EMC Directive. Conformity of this product with any other "CE Mark" Directive(s) shall not be assumed. EMC Classification: EN 50081-2-1993 Electromagnetic Compatibility – General Emission Standard, Part 2: Industrial Environment. EN 50082-2-1995 Electromagnetic Compatibility – General Immunity Standard, Part 2: Industrial Environment.
Safety protection	Complies with EN61010-1 and UL 3121 for process control instrumentation. Pollution Degree 2. Installation Category II
Electrical insulation Input to input Input to ground Input to line voltage Line voltage to ground Alarm relay to ground Logic input to ground	Continuous voltage up to 280 VAC or 400 VDC (except for RTD input) Test voltage 2.1 kVDC for 1 minute Test voltage 2.1 kVDC for 1 minute Test voltage 2.1 kVDC for 1 minute Test voltage 2.1 kVDC for 1 minute Test voltage 500 VDC for 1 minute
Temperature Ambient Storage	0 to 60°C (32 to 140°F) - Roll chart 0 to 50°C (32 to 120°F) – Fan fold -40 to +70°C (-40 to +160°F)
Humidity Roll Fan-fold	10 to 90% RH non-condensing 15 to 80% RH non-condensing
Vibrations	Frequency 10 to 60 Hz, amplitude 0.07 mm; 60 to 150 Hz, acceleration 1 g

Accuracy**DPR100 C/D**

Reference conditions Temperature Humidity Line voltage nominal Source resistance Series mode Common mode Frequency nominal	23 °C ± 2 °C (73 °F ± 3 °F) 65 % RH ± 5 % RH ± 1 % 0 ohms 0 V 0 V ± 1 %		
Accuracy	Accuracy of displayed values: 0.1 % of selected input range (IEC 873) (except for ranges marked **, see below) Cold junction accuracy: 0.5 °C For mA inputs, the accuracy of the input resistor shall be added to the instrument accuracy, Chart resolution: 0,2 mm.		
Rated limits and associated drifts	Parameter	Rated limits	Influence on accuracy
	Temperature junction	0 to 50°C (32 to 120°F) Fanfold, 0 to 60°C (32 to 140°F) Chart Roll	0.1% per 10°C (50°F) Cold 0.3°C /10°C (32.5°F / 50°F)
	Supply voltage	85 to 264 V AC	No influence
	Source resistance	T/C, mV	6 micro V per 100Ω of line
		RTD	1000Ω mm 0.1°C per Ω in each wire
	balanced		leads 40Ω max.
	Humidity	10 to 90% RH at 25°C	0.1 % max.
	Long-term stability		0.1 % per year
	Vibrations	1.25 mm at 0 to 14 Hz 1 g at 14 to 250 Hz	
Extreme conditions:			
Operating Temperature Humidity	0 to 60°C (32 to 140°F) 10 to 90% RH non-condensing		
Storage Temperature Humidity	-40 to +70°C (-40 to 158°F) 5 to 95% RH non-condensing		

Minimum system requirements for PC software**DPR100 C/D****NOTE: Make sure you are an “Administrator” before installing the product.**

- Windows 7 Professional, Ultimate or Enterprise OS 32-bit or 64-bit edition requires 1 GHz Processor, 2GB RAM and 15GB Hard Disk Space
- Windows XP SP1 professional requires a 233 Mhz CPU with 128 MB of RAM
- Windows 2000 SP4 professional requires a Pentium 133 Mhz CPU with 64 MB of RAM
- Windows NT Workstation 4.0 SP5 requires a 486 Mhz CPU with 32 MB of RAM
- Windows 98SE requires a Pentium 150MHz processor with 32 MB of RAM
- 10MB free on your hard disk for the PC Configuration software.
- Recommended video resolution: 800x600 or higher.

Available ranges

DPR100 C/D

Linear	RTD/OHMS		Thermocouple			
0/10 mV	Pt 100 ohm at 0°C		J -50/150°C	S 0/1600°C	U -50/150°C	
-10/10 mV	** IEC -50/150°C	**JIS -50/150°C	J -58/302°F	S 32/2912°F	U -58/302°F	
0/20 mV	** IEC -58/302°F **	**JIS -58/302°F	J 0/400°C	S -20/1760°C	U 0/150°C	
-20/20 mV	** IEC 0/100°C **	**JIS 0/100°C	J 32/752°F	S -4/3200°F	U 32/302°F	
0/50 mV	** IEC 32/212°F	**JIS 32/212°F	J -200/870°C		U 50/150°C	
-50/50 mV	** IEC 0/200°C	**JIS 0/200°C	J -328/1598°F	N 0/400°C	U 122/302°F	
10/50 mV	** IEC 32/392°F	**JIS 32/392°F		N 32/752°F	U -200/400°C	
0/100 mV	** IEC 0/400°C	**JIS 0/400°C	L -50/150°C	N 0/800°C	U -328/752°F	
-100/100 mV	** IEC 32/752°F	**JIS 32/752°F	L -58/302°F	N 32/1452°F		
0/500 mV	** IEC -200/500°C	**JIS -200/500°C	L 0/400°C	N 0/1200°C	NiMo 0/1400°C	Reference Accuracy Range
-500/500 mV	** IEC -328/1932°F	**JIS -328/1932°F	L 32/752°F	N 32/2192°F	NiMo 32/2552°F	
0/1 V			L -200/870°C	N -20/1300°C		
-1/1 V	** Ni 50 ohm -80/320°C		L -328/1598°F	N -4/2372°F	W-W 26 -20/2320°C	400 to 2300°C
0/2 V	** Ni 50 ohm -112/608°F				W-W 26 -4/4208°F	750 to 4200°F
-2/2 V	** Ni 508 ohm -50/250°C		K 0/400°C	T -50/150°C	W5-W 26 -20/2320°C	400 to 2300°C
0/5 V	** Ni 508 ohm -58/482°F		K 32/752°F	T -58/302°F	W5-W 26 -4/4208°F	750 to 4200°F
-5/5 V	** Cu 10 ohm -20/250°C		K 0/800°C	T 0/150°C		
1/5 V	** Cu 10 ohm -4/482°F		K 32/1452°F	T 32/302°F	PR 20-40 0/1800°C	1100 to 1800°C
0/10 V	OHM 0/200		K 0/1200°C	T 50/150°C	PR 20-40 32/3272°F	2010 to 3270°F
-10/10 V	OHM 0/2000		K 32/2192°F	T 122/302°F		
0/20 mA *			K -200/1370°C	T -200/400°C	B 40/1820°C	600 to 1820°C
4/20 mA *			K -328/2498°F	T -328/752°F	B 104/3308°F	1110 to 3300°F
			R -20/1760°C			
			R -4/3200°F			

Notes: **: Accuracy: 1 °C (or 1.8 °F)

For non-linear temperature transmitter (1 to 5 V DC, 4 to 20 mA, 0 to 5 V DC, 0 to 20 mA) the transmitter range must be identical to the full actuation range of the recorder. Provision for T/C input for remote compensation box at fixed temperature of 50°C or 60°C. When temperature is not fixed, any input can be used as remote compensation temperature measurement. * mA inputs into 250 ohms input resistor.

DIMENSIONS

DPR100 C/D

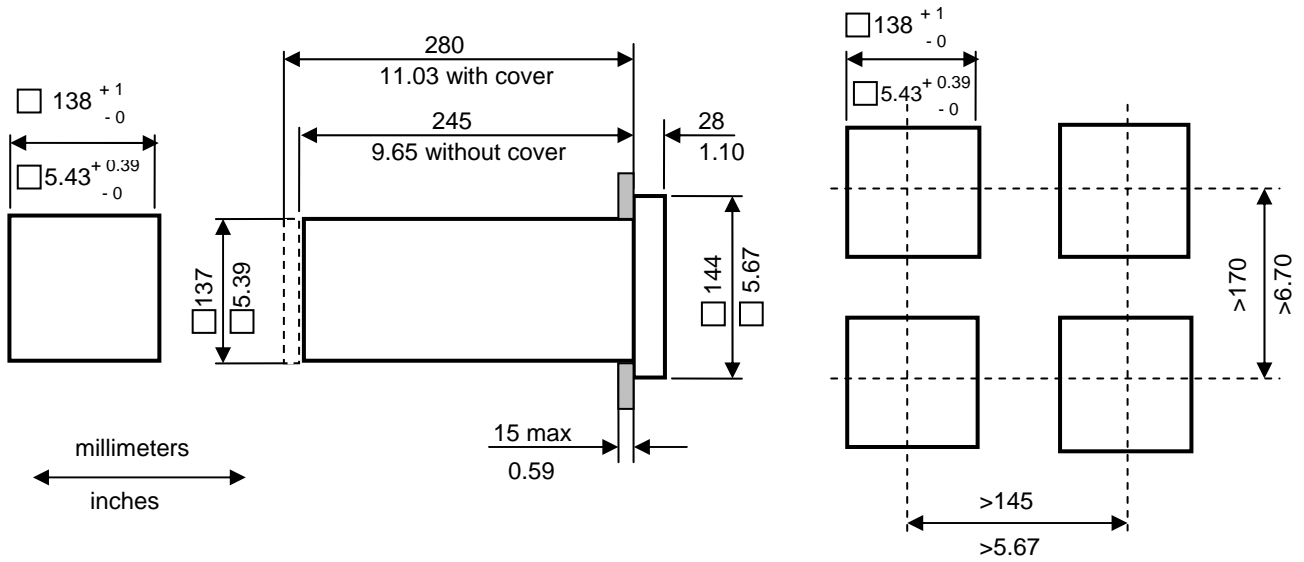

CONNECTIONS

DPR100 C/D

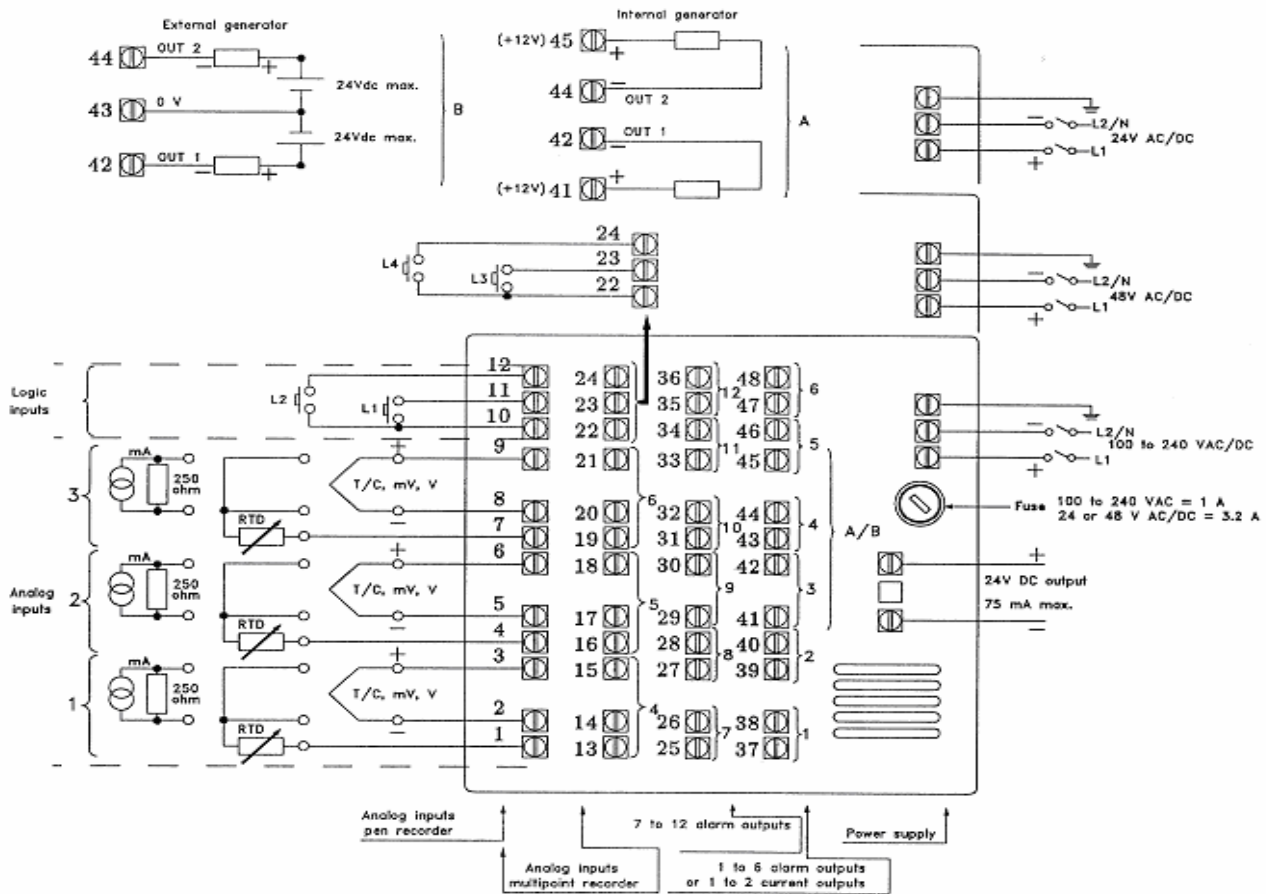

Warranty/Remedy

Honeywell warrants goods of its manufacture as being free of defective materials and faulty work-manship. Contact your local sales office of warranty information. If warranted goods are returned to Honeywell during the period of coverage, Honeywell will repair or replace without charge those items it finds defective. ***The foregoing is Buyer's sole remedy and is in lieu of all other warranties, expressed or implied, including those of merchantability and fitness for a particular purpose.*** Specifications may change without notice. The information we supply is believed to be accurate and reliable as of printing. However, we assume no responsibility for its use. While we provide application assistance personally, through our literature and the Honeywell website, it is up to the customer to determine the suitability of the product in the application.

Sales and Service

For application assistance, current specifications, pricing, or name of the nearest Authorized Distributor, contact one of the offices below.

ASIA PACIFIC

Control Products

Asia Pacific Headquarters
Phone: +(65) 6355-2828
Fax: +(65) 6445-3033

Asia Pacific Global Technical Support

Field Instruments
Phone: +65 6580 3156
Fax: +65 6445-3033

Process Instruments

Phone: (603) 76950 4777
Fax: (603) 7958 8922

Australia

Honeywell Limited
Phone: +(61) 7-3846 1255
FAX: +(61) 7-3840 6481
Toll Free 1300-36-39-36
Toll Free Fax:
1300-36-04-70

China – PRC - Beijing

Honeywell China Inc.
Phone: +(86-10) 8458-3280
Fax: +(86-10) 8458-4650

China – PRC - Shanghai

Honeywell China Inc.
Phone: (86-21) 5257-4568
Fax: (86-21) 6237-2826

China – PRC - Chengdu

Honeywell China Inc.
Phone: +(86-28) 8678-6348
Fax: +(86-28) 8678-7061

China – PRC - Xi'an

Honeywell China Ltd - Xi'an.
Phone: +(86-29) 8833-7490
Fax: +(86-29) 8833-7489

China – PRC - Shenzhen

Honeywell China Inc.
Phone: +(86) 755-2518-1226
Fax: +(86) 755-2518-1221

Indonesia

PT Honeywell Indonesia
Phone: +(62) 21-535-8833
FAX: +(62) 21-5367 1008

India Automation India Ltd.

Honeywell Ltd.
Phone: +(91) 5603-9400
Fax: +(91) 5603-9600

Japan

Honeywell Inc.
Phone: +(81) 3 6730 7150
Fax: +(81) 3 6730 7228

Malaysia

Honeywell Engineering
Sdn Bhd
Phone: +(60-3) 7950-4776
Fax: +(60-3) 7958-8922

New Zealand

Honeywell Limited
Phone: +(64-9) 623-5052
Fax: +(64-9) 623-5060
Toll Free (0800) 202-088

Philippines

Honeywell Systems
(Philippines) Inc.
Phone: +(63-2) 633-2830-31/
636 1661-62
Fax: +(63-2) 638-4013

Singapore

Honeywell Pte Ltd.
Phone: +(65) 6580 3278
Fax: +(65) 6445-3033

South Korea

Honeywell Korea Co Ltd
Phone: +(822) 799 6315
Fax: +(822) 792 9015

Thailand

Honeywell Systems
(Thailand) Ltd.
Phone: +(662) 693-3099
FAX: +(662) 693-3089

Taiwan R.O.C.

Honeywell Taiwan Ltd.
Phone: +(886-2) 2245-1000
FAX: +(886-2) 2245-3241

SE Asia Countries

see Honeywell Pte Ltd
(Singapore)
for: Pakistan, Cambodia,
Guam, Laos, Myanmar,
Vietnam, East Timor

SE Asia Countries

see Honeywell Automation
India Ltd for:
Bangladesh
Nepal
Sri Lanka

EUROPE

Austria

Honeywell Austria GmbH
Phone: +43 (316)400123
FAX: +43 (316)40017

Belgium

Honeywell SA/NV
Phone: +32 (0) 2 728 24 07
FAX: +32 (0) 2 728 22 45

Bulgaria

Honeywell EOOD
Phone: +(359) 2 40 20 900
FAX: +(359) 2 40 20 990

Czech Republic

Honeywell spol. s.r.o.
Phone: +420 242 442 232
FAX: +420 242 442 131

Denmark

Honeywell A/S
Phone: +(45) 39 55 55 55
FAX: +(45) 39 55 55 58

Finland

Honeywell OY
Phone: +358 (0)20752 2753
FAX: +358 (0) 20752 2751

France

Honeywell SA
Phone: +33 (0)1 60198075
FAX: +33 (0)1 60198201

Germany

Honeywell AG
Phone: +49 (69)8064-299
FAX: +49 (69)806497336

Hungary

Honeywell Kft.
Phone: +36-1-451 4300
FAX: +36-1-451 4343

Italy

Honeywell S.p.A.
Phone: +390292146307
FAX: +39 0292146377

The Netherlands

Honeywell B.V.
Phone: +31 (0) 20 5656200
FAX: +31 (0) 20 5656210

Norway

Honeywell A/S
Phone: (45) 39 55 55 55

Poland

Honeywell Sp. zo.o
Phone: +48-22-6060900
FAX: +48-22-6060901

Portugal

Honeywell Portugal Lda
Phone: +351 21 424 5000
FAX: +351 21 424 50 99

Romania

Honeywell Bucharest
Phone: +40 (0) 21 2316437
FAX: +40 (0) 21 2316439

Russian Federation (RF),

ZAO "Honeywell"
Phone: +7 (095) 796 98 00
FAX: +7 (495) 797 99 64

Slovak Republic

Honeywell s.r.o.
Phone: +421-2-58247 410
FAX: +421-2-58247 415

Spain

Honeywell S.A.
Phone: +34 (0)91313 61 00
FAX: +34 (0)91313 61 30

Sweden

Honeywell AB
Phone: +(46) 8 775 55 00
FAX: +(46) 8 775 56 00

Switzerland

Honeywell AG
Phone: +41 18552448
FAX: +(41) 1 855 24 45

Turkey

Honeywell Turkey A.S.
Phone: +90 216 578 71 00
FAX: +90 216 575 66 35

Ukraine

Honeywell
Tel: +380-44-201 44 74
Fax: +380-44-201-44-75

United Kingdom

Honeywell Control Systems
Ltd.
Phone: +44 (0)1344
655251
FAX: +44 (0) 1344 655554

MIDDLE EAST

Abu Dhabi U A E

Middle East Headquarters
Honeywell Middle East Ltd.
Phone: +971 2 4041246
FAX: +971 2 4432536

Sultanate of Oman

Honeywell & Co Oman LLC
Phone: +968 24 701153/
Ext.33
FAX +968 24 787351

Saudia Arabia

Honeywell Turki Arabia Ltd
Jubail Office
Phone: +966-3-341-0140
Fax: +966-3-341-0216
Honeywell - ATCO
Dammam Office
Phone: 0096638304584
Fax: 0096638338059

Kuwait

Honeywell Kuwait KSC
Phone: +965 242 1327 to
30
Fax: +965 242 8315
And
Phone: +965 326
2934/1821 Fax: +965 326
1714

AFRICA

Mediterranean & African Distributors

Honeywell SpA
Phone: +39 (02) 250 10 604
FAX: +39 (02) 250 10 659

South Africa (Republic of) and sub saharan

Honeywell Southern Africa
Honeywell S.A. Pty. Ltd.
Phone: +27 11 6958000
FAX +27 118051504

NORTH AMERICA

Canada

Honeywell LTD
Phone: 1-800-737-3360
FAX: 1-800-565-4130

USA

Honeywell Process
Solutions,
Phone: 1-800-423-9883 or
1-800-343-0228

Email: ask-ssc@honeywell.com

SOUTH AMERICA

Argentina

Honeywell S.A.I.C.
Phone: +(54-11) 4383-3637
FAX: +(54-11) 4325-6470

Brazil

Honeywell do Brasil & Cia
Phone: +(55-11) 7266-1900
FAX: +(55-11) 7266-1905

Chile

Honeywell Chile, S.A.
Phone: +(56-2) 233-0688
FAX: +(56-2) 231-6679

Mexico

Honeywell S.A. de C.V.
Phone: +(52) 55 5259-1966
FAX: +(52) 55 5570-2985

Puerto Rico

Honeywell Inc.
Phone: +(809) 792-7075
FAX: +(809) 792-0053

Trinidad

Honeywell Inc.
Phone: +(868) 624-3964
FAX: +(868) 624-3969

Venezuela

Honeywell CA
Phone: +(58-2) 238-0211
FAX: +(58-2) 238-3391

Honeywell

Honeywell Process Solutions

1860 West Rose Garden Lane
Phoenix, Arizona 85027
Phone: 1-800-423-9883 or 1-800-343-0228

www.honeywell.com/ps

EN0i-6021

March 2010

©2009-10 Honeywell International Inc.