

A70QS FRENCH CYLINDRICAL SEMICONDUCTOR PROTECTION FUSES



These Premium Amp-trap® French Cylindrical Semiconductor Fuses are an extension of the popular A70QS product line. They are solid-fill 14mm and 22mm fuses, IEC rated 690VAC, 200kA Interrupting and 700VDC, 100kA interrupting at 10ms time constant. In addition, these fuses have an 890 VDC rating for capacitor discharge applications up to 2.5ms time constant. All ampere ratings are available with a striker. Applications include small inverter drives and UPS systems, with superior I²t for improved protection and performance.

Features/Benefits

- **International 14x51mm (2"x9/16") and 22x58mm (2-1/4"x13/16") sizes** for worldwide acceptance
- **Ferrule mount** up to 100A for design versatility
- **Very low I²t** for improved semiconductor protection
- **690V IEC rated**, tested at 760VAC; can be used up to 750VAC in U.S.
- **700VDC rated** for dc protection of equipment with L/R ≤10ms
- **Superior cycling ability** for longer life on difficult cyclic loading applications
- **aR characteristic** for semiconductor short-circuit protection

HIGHLIGHTS:

- 14 x 51 and 22 x 58 sizes
- 690VAC IEC Rated (760VAC Max.)
- 700VDC rated
- Superior Cycling Ability
- Low Watts Loss
- Optional Striker for Visual/Remote Indication

APPLICATIONS:

- Small inverters, UPS systems, motor drives and similar 700V or less equipment

Ratings

- **AC:** 10-100A
690VAC, 200kA I.R.
IEC tested at 760VAC
- **DC:** 700VDC,
100kA I.R.
Contact factory for details

Approvals

- UL Recognized Component
File E76491
- CSA Certified
- IEC 269-4 Compliance



Mounting:

- US14 or US22 “finger-safe” IP 20 grade holders, DIN rail or screw mount, with striker actuated microswitch indication available.
- 703 Series open fuse blocks

Catalog Numbering System

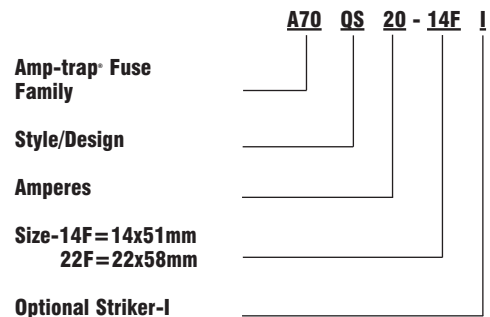

A70QS

FRENCH CYLINDRICAL SEMICONDUCTOR PROTECTION FUSES

Ratings and Application Data

BODY SIZE (mm)	AMP RATING (A)	MELTING I ² t (A ² s X 10 ³)	MAX. CLEARING I ² t @ 700VAC (A ² s X 10 ³)	WATTS LOSS @ RATED CURRENT (W)	CATALOG NUMBER	
					NO STRIKER	WITH STRIKER
14 x 51	6	0.0013	0.017	2.0	A70QS6-14F	A70QS6-14FI
	8	0.0024	0.027	2.8	A70QS8-14F	A70QS8-14FI
	10	0.0043	0.04	3.5	A70QS10-14F	A70QS10-14FI
	12	0.0054	0.06	4.4	A70QS12-14F	A70QS12-14FI
	16	0.0132	0.10	4.8	A70QS16-14F	A70QS16-14FI
	20	0.027	0.16	5.2	A70QS20-14F	A70QS20-14FI
	25	0.053	0.27	5.8	A70QS25-14F	A70QS25-14FI
	32	0.098	0.50	7.0	A70QS32-14F	A70QS32-14FI
	40	0.13	0.70	10.7	A70QS40-14F	A70QS40-14FI
	50	0.28	1.50	11.6	A70QS50-14F	A70QS50-14FI
22 x 58	10	0.0043	0.025	4.0	A70QS10-22F	A70QS10-22FI
	15	0.008	0.049	6.2	A70QS15-22F	A70QS15-22FI
	20	0.013	0.076	8.0	A70QS20-22F	A70QS20-22FI
	25	0.02	0.125	10.0	A70QS25-22F	A70QS25-22FI
	32	0.49	0.27	11.0	A70QS32-22F	A70QS32-22FI
	40	0.88	0.48	13.0	A70QS40-22F	A70QS40-22FI
	50	0.16	0.80	14.9	A70QS50-22F	A70QS50-22FI
	63	0.35	1.85	16.0	A70QS63-22F	A70QS63-22FI
	70	0.52	2.80	16.5	A70QS70-22F	A70QS70-22FI
	80	0.73	3.80	17.8	A70QS80-22F	A70QS80-22FI
	90	1.10	5.64	17.0	A70QS90-22F	A70QS90-22FI
	100	1.56	8.00	19.0	A70QS100-22F	A70QS100-22FI



*100kA, L/R = 11.6ms

No Striker

FUSE SIZE	DIMENSIONS-mm		
	A	B	C
14 x 51	14	51	14
22 x 58	22	58	16

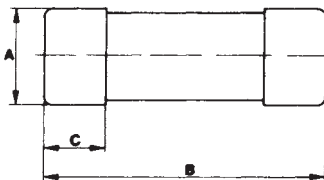

With Striker

FUSE SIZE	DIMENSIONS-mm				
	A	B	C	D	E
14 x 51	14	51	14	7.5	3.8
22 x 58	22	58	16	7.5	3.8

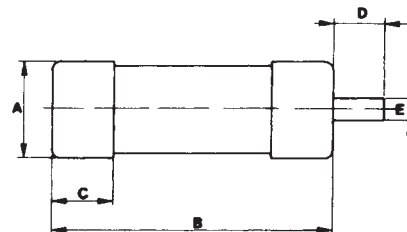

A70QS FRENCH CYLINDRICAL SEMICONDUCTOR PROTECTION FUSES

Melting Time-Current Data

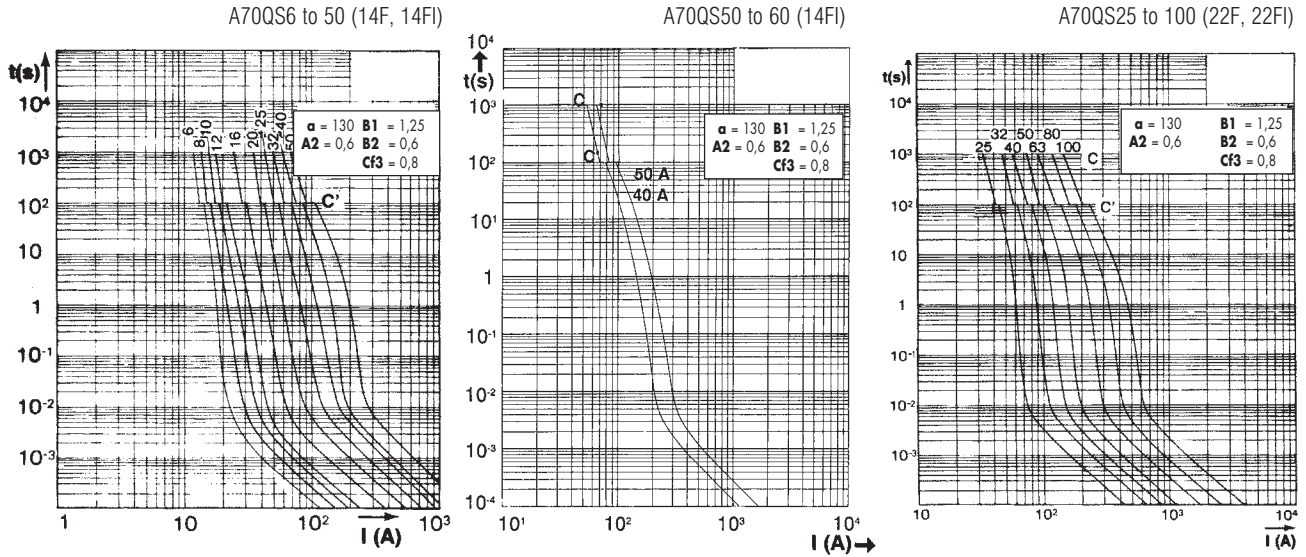

These curves indicate, for each rated current, the pre-arcing (melting) time vs. the R.M.S. current.

Clearing I^2t vs. Operating Voltage

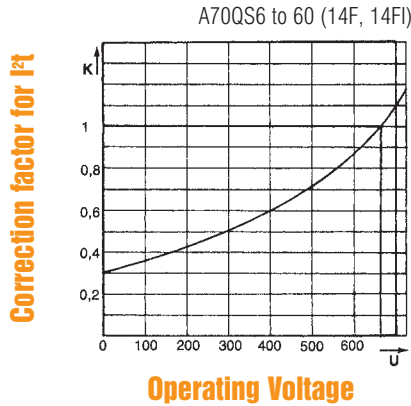

Peak arc voltage vs. Operating Voltage

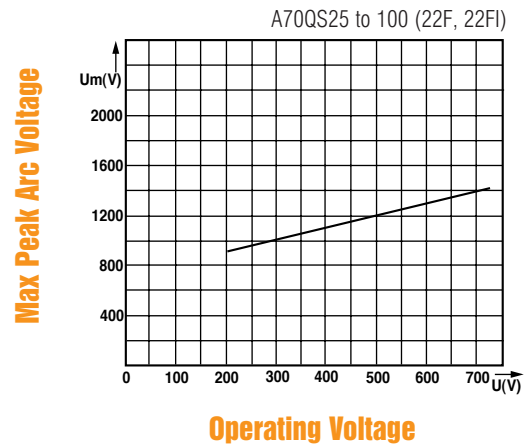
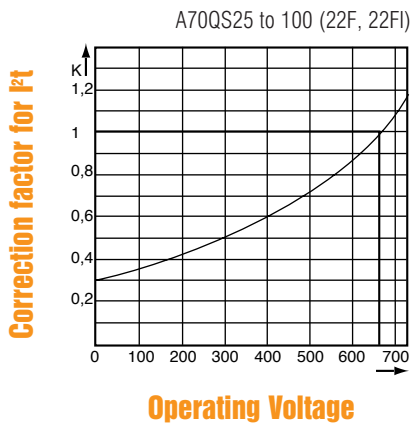
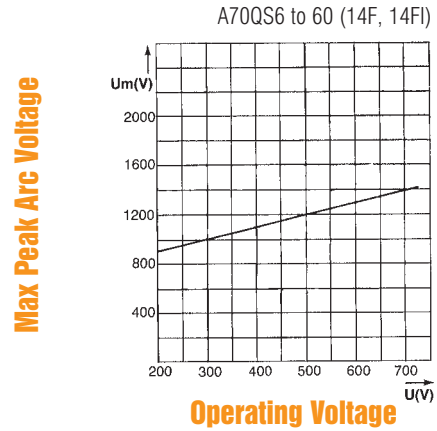

A70QS FRENCH CYLINDRICAL SEMICONDUCTOR PROTECTION FUSES

D.C. Applications Data

DC Voltage Capabilities vs. Time Constant

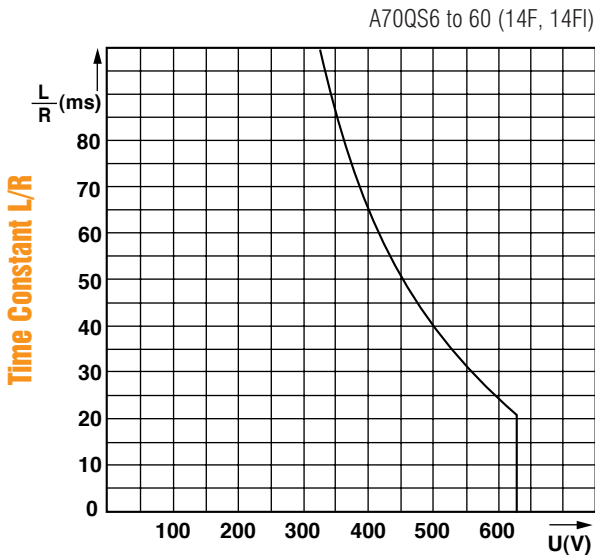

DC Voltage Capability

Peak Arc voltage vs. DC circuit voltage

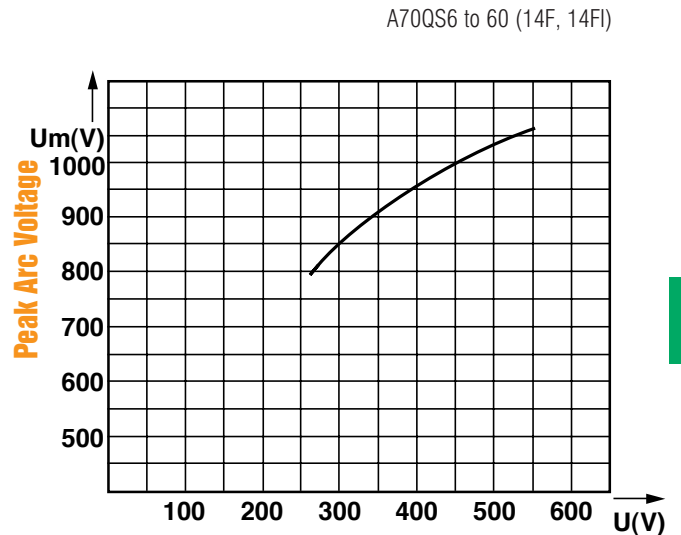

DC Circuit Voltage

See melting-time current data for minimum breaking current.

DC Voltage Capabilities vs. Time Constant

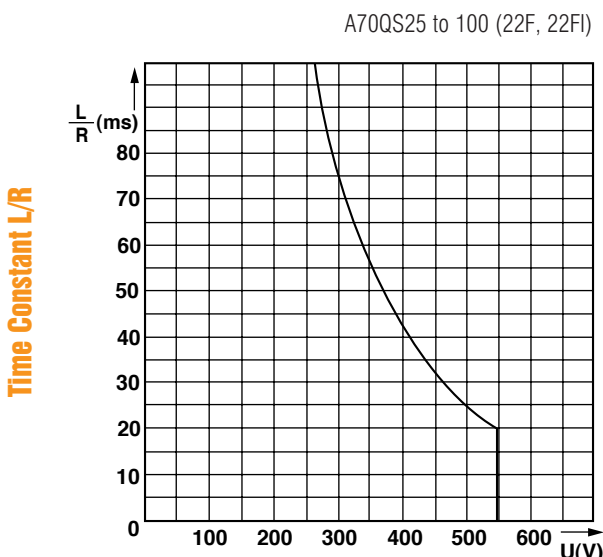

DC Voltage Capability

Peak Arc voltage vs. DC circuit voltage

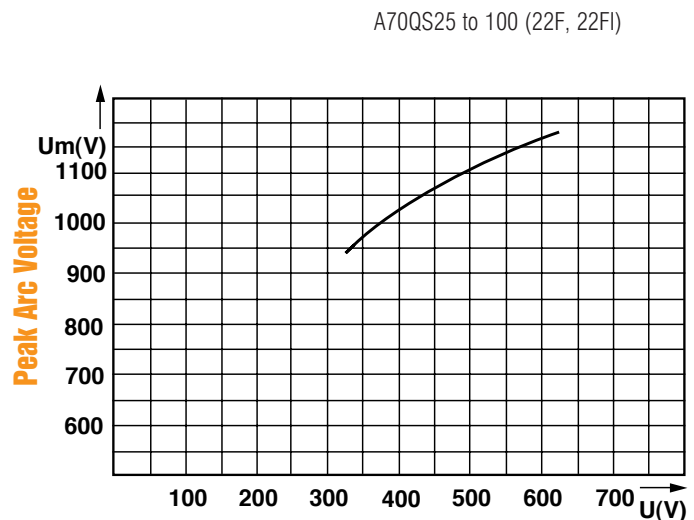

DC Circuit Voltage

These curves provide the DC voltage capability of the fuse as a function of circuit time constant. (L/R ratio)

These curves show the peak value U_m of the arc voltage which appears across the fuse link as a function of the operating voltage U .

