

Midi Industrial Relay Type RMI. 2-10 10A Monostable

CARLO GAVAZZI

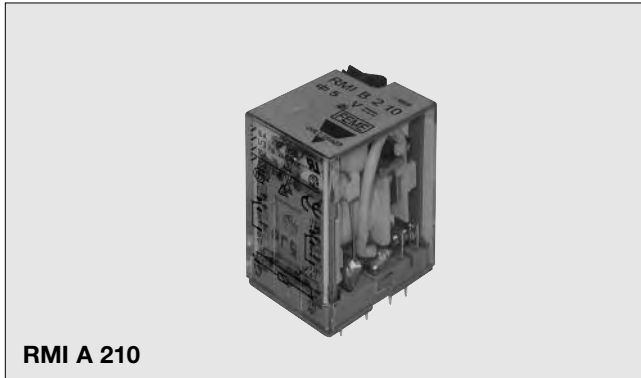

RMI A 210

- High switching power
- Small size
- 2 poles configuration
- AC coils 6 to 230VAC
- DC coils 5 to 110VDC
- 3750VAC dielectric coil to contacts
- Standard with LED, Push with arm and Flag
- IP 40
- Compliant with the CE low voltage directive
- TÜV, UL, CSA, IMQ approved

Product Description

The RMI relay (relay mini-industrial) can be used for a wide range of industrial applications.

Available in 2 change-over contact configuration. PCB, solder and plug-in terminals.

Approvals



Ordering Key

RMI A 210 12DC /1

Type _____
Terminal version _____
Contact code _____
Coil code _____
Options _____

Terminal version: A = Soldering terminals
B = PCB terminals

Box content: 25 relays
Box size: (W 125 x D 165 x H 50) mm Weight: 850g
(W 4.92 x D 6.50 x H 1.97) inches Weight: 29.98oz

Type Selection

Contact configuration	Contact rating	Contact code
2 change over contacts (DPDT {2-form C})	10A	210

Coil Characteristics, DC 0.9W

Coil Code	Nominal voltage VDC	@ +20°C (+68°F)		Coil resistance Ω
		Pick-up voltage VDC	Drop-out voltage DVC	
5VDC	5	4.0	0.5	27.5 ±10%
6VDC	6	4.8	0.6	40.0 ±10%
12VDC	12	9.6	1.2	160.0 ±10%
24VDC	24	19.2	2.4	650.0 ±10%
48VDC	48	38.4	4.8	2600.0 ±15%
60VDC	60	48.0	6.0	11000.0 ±15%
110VDC	110	88.0	11.0	11000.0 ±15%

Coil Characteristics, AC 1.2VA

Coil Code	Nominal voltage VAC	@ +20°C (+68°F)		Coil resistance Ω
		Pick-up voltage VAC	Drop-out voltage VAC	
6VAC	6	4.8	1.8	40.0 ±10%
12VAC	12	9.6	3.6	160.0 ±10%
24VAC	24	19.2	7.2	650.0 ±10%
48VAC	48	38.4	14.4	2600.0 ±10%
115/120VAC	110-120	96.0	36.0	11000.0 ±15%
230VAC	220-240	176.0	66.0	11000.0 ±15%

Options

Nil = Standard with Push Arm -LED (A1+) (A2-)- Flag
/0 = Diode against polarity reverse + free-wheeling Diode (A1+) (A2-)
/1 = Without LED
/2 = Without Flag
/3 = Without Push Arm
/4 = Plated Contacts Au > 5µm
/5 = Flash Gilded Contacts Au > 1µm
/6 = Free-Wheeling Diode (A1+) (A2-)
/7 = Free-Wheeling Diode (A1-) (A2+)

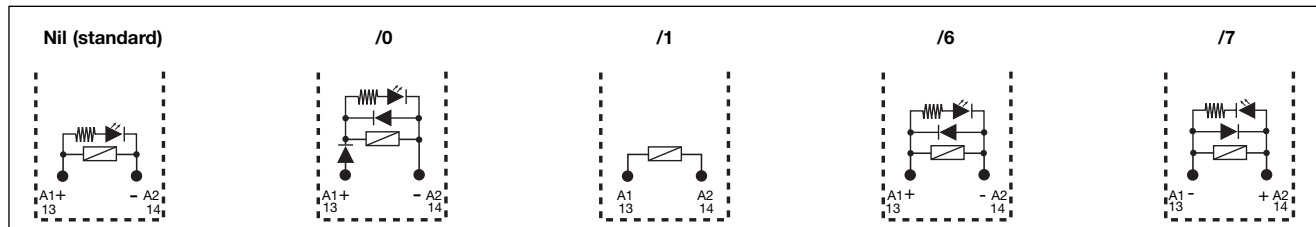

Contact Characteristics

Contact rating (with resistive load)	10A - 250VAC / 30VDC	Minimum Current Min. applicable load /4 and /5 versions	5mA @ 12VDC 1mA @ 6VDC
UL rating	10A - 250VAC / 30VDC 1/3HP @ 240VAC	Max. switch. voltage	250VAC / 30VDC @ 10A
Max. rating	10A - 250VAC / 30VDC	Max. switch. power	2500VA / 300W @ 10A
Material	AgCe	Life Electrical life Mechanical life	1x10 ⁵ cycles (1800 Ops/h) 1x10 ⁷ cycles (1800 Ops/h)
Initial contact resistance	50mΩ (@ 1A 6VDC)		

Insulation

Test Voltage (1 min.) Between coil and contacts Between open contacts Contact/Contact	3750VAC Vr.m.s 750VAC Vr.m.s 1250VA Vr.m.s	Insulation according to EN61810-5 Rated insulation voltage Impulsive insulation voltage Pollution degree Overvoltage category	250V 3.6kV 2 III
Initial insulation resistance	1.000MΩ - 500VAC		

General Data

Nominal coil power	0.9W DC / 1.2VA AC	Shock resistance Functional Destructive	100m/s ² /10g 11ms 1000m/s ² /100g
Operating time (At nominal voltage)	20ms max.	Humidity	35% to 95% RH non-condensing
Release time (At nominal voltage)	20ms max.	Terminals	PCB or Soldering Lugs (Plug-in)
Ambient temperature	-55° to +70°C (-67° to +158°F)	Weight	~37g (~1.30oz)
Vibration resistance	10 to 55Hz 1.0mm (0.04")		
Construction	Dust cover		

Pin View mm/inches

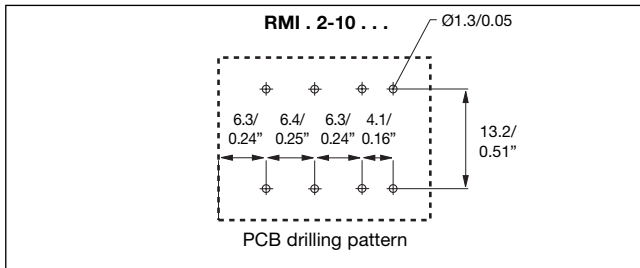

Wiring Diagram

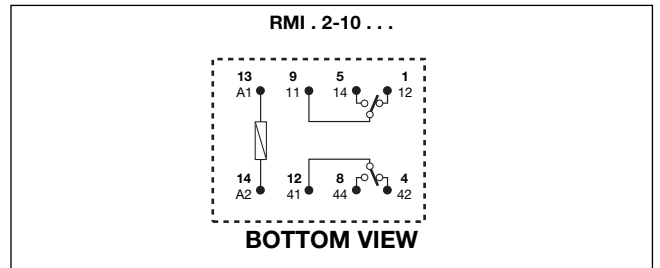

Dimensions mm/inches

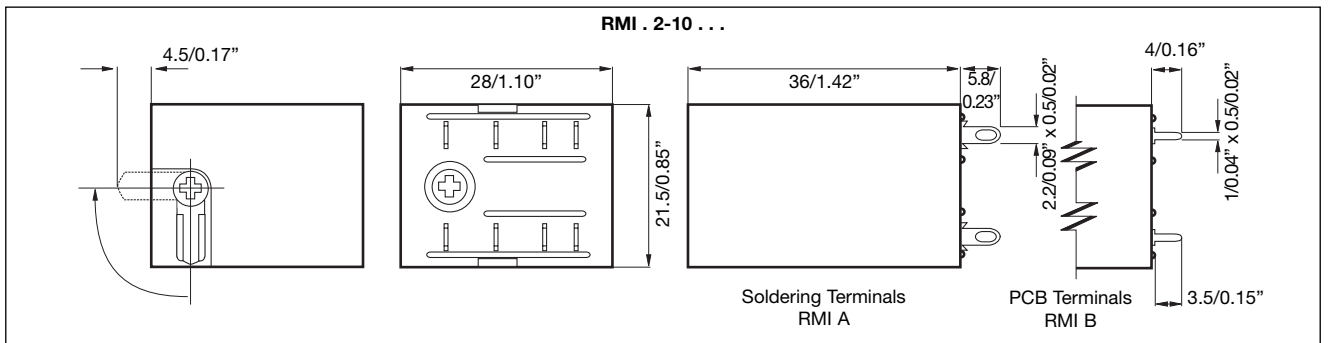

Diagrams

1 Coil Operating Range

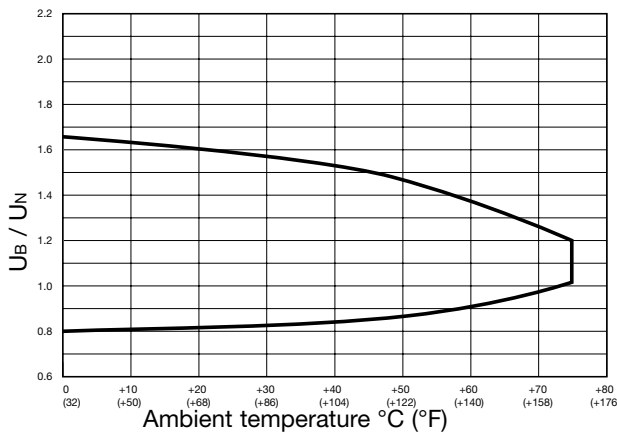

2 Max. DC load breaking capacity

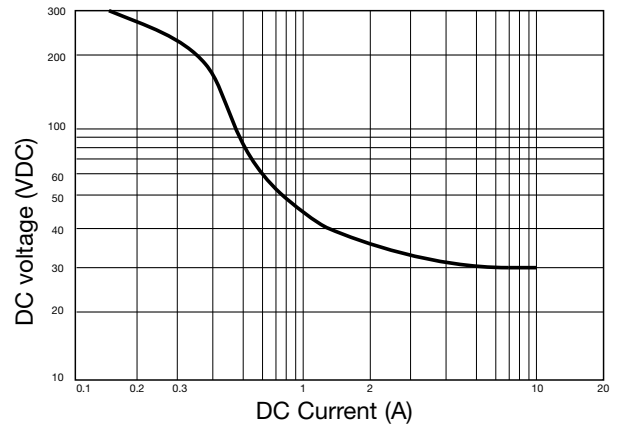

3 Electrical life

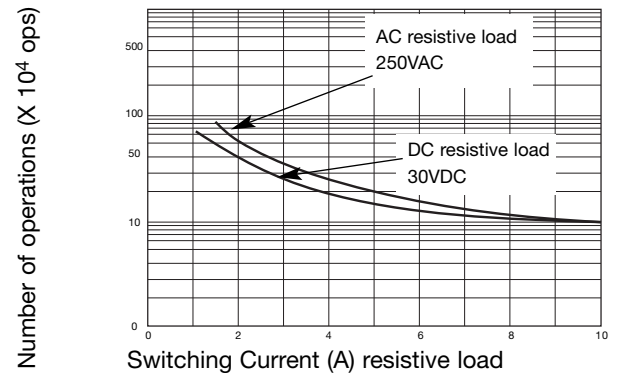
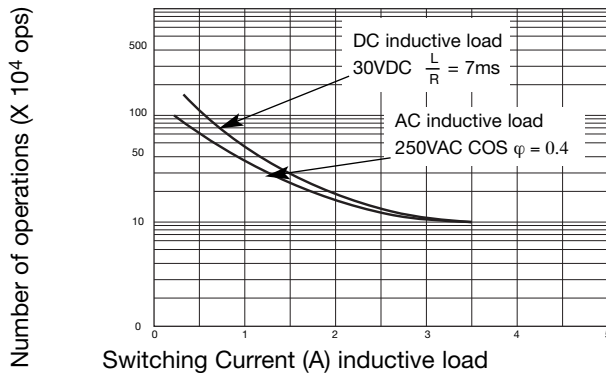

Bases and Sockets

DIN rail sockets codes are **ZMI2NA, ZMI4NA, ZMI2SA, ZMI4SA, ZMI2GA, ZMI4GA, ZR08** and **ZDM14A** details and specifications from page 45 to 49 of industrial relays catalogue.

PCB sockets codes are **ZC15/2A, ZC15/4A, ZC15/2** and **ZC15/4** details and specifications on page 51 of industrial relays catalogue.

Specifications are subject to change without notice. Pictures are just an example. For special features and/or customization, please ask to our sales network