

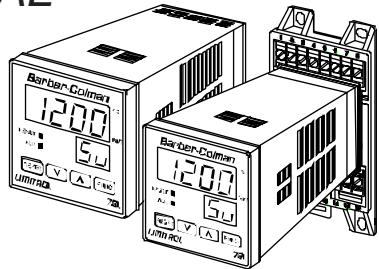

# INSTRUCTION MANUAL

1262-IN-023-0-02  
January 1998



Model 7SL  
High/Low Limitrol

# 1/16 DIN FOUR DIGIT HIGH/LOW LIMITROL

Model 0 7 S L - 9 1 □ □ □ - □ 0 0 - 0 - 0 0  
Field No. 1 2 3 4 5 6 7 8 9 10 11 12 13 14 15

## Field 1 through 4. BASE

07SL - Limitrol (High/Low Limit. Shipped as high limit)

## Field 5. INPUT

9 - TC Types J, K, T, E, N, S, R, B, L, U, G, D and Platinel II; and Pt 100 RTD;  
0 to 20 mAdc and 4 to 20 mAdc  
0 to 60 mVdc and 12 to 60 mVdc  
0 to 5 Vdc or 1 to 5 Vdc  
0 to 10 Vdc or 2 to 10 Vdc

Note: All inputs are factory calibrated and selectable by jumper. Factory set at Type J.

## Field 6. OUTPUT (High/Low Limit)

1 - Relay (Form C)

## Field 7, 8. ALARMS, OPTIONS

00 -None  
10 -One alarm - Relay Form A  
11 -One alarm - Relay Form A, plus RS-485 and one logic input.

Note: When code 11 is specified, instrument length is 4.8 inches (122 mm)

## Field 9. POWER SUPPLY

3 - 100 to 240 Vac  
5 - 24 Vac/Vdc

## Field 10. Mounting

0 - Panel Mount  
R - Wall or Rail Mount

Fields 11 through 15. RESERVED

## Congratulations

. . . on your purchase of one of the easiest to configure controllers on the market. After a three step configuration procedure, your process will be up and running.

If for any reason you encounter difficulty with the controller set-up, please call your supplier.

### Guide to Simple Set-up

To set-up the controller, only four steps are required:

1. Wire the instrument.
2. Configure the instrument.
3. Check the operating mode parameters.

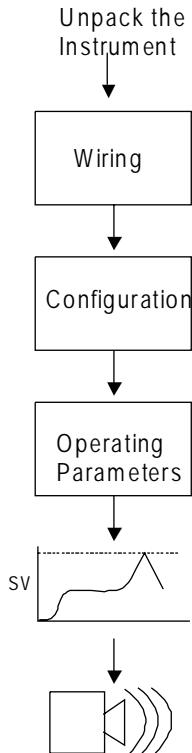

## Contents

Mounting Requirements .....	5
Panel Mount Controller -----	5
Mounting Requirements .....	6
Wall or Rail Mount Controller -----	6
Dimensions and Rear Terminal Blocks .....	7
Panel Mount Controllers -----	7
Dimensions .....	9
Wall or Rail Mount Controller -----	9
Wiring Guidelines .....	10
Panel Mount Controllers -----	10
Wiring Guidelines .....	14
Wall or Rail Mount Controller -----	14
Preliminary Hardware Settings .....	20
Configuration Procedure .....	21
Operating Mode .....	27
Error Messages .....	32
General Specifications .....	33
Calibration .....	37
Calibration Parameters -----	38
Procedure -----	38
Maintenance.....	44
APPENDIX A .....	45
Default parameters -----	45
APPENDIX B .....	47
Thermocouple Compensating Cable	
Color Codes. -----	47

### CAUTION!

USE WIRE SUITABLE  
FOR 75° MINIMUM

#### NOTES:

- For supply connections use 16 AWG or larger wires rated for at least 75° C
- Use copper conductors only
- Class 2 wiring must be separated a minimum of 1/4 inch from any class 1 conductor

### IMPORTANT!

Terminal identification of the panel mount controller is different from terminal identification of the wall/rail mount controller! This manual contains wiring instructions for both types of controllers.

Be sure to follow the instructions that pertain to the controller you are using.

# Mounting Requirements

## Panel Mount Controller

Select a mounting location with the following characteristics:

- 1) Minimal vibration.
- 2) An ambient temperature range between 0 and 50°C (32 and 122 °F).
- 3) Easy access to the rear of the instrument.
- 4) No corrosive gases (sulfuric gas, ammonia, etc.).
- 5) No water or other fluid (i.e. condensation).
- 6) Relative humidity of 20% to 80% non condensing.

The instrument can be mounted on a panel up to 15 mm (0.591 in) thick with a square cutout of 45 x 45 mm (1.772 x 1.772 in). For outline refer to Dimensions and Panel Cutout.

Panel surface texture must be better than 248 microinches.

The instrument is shipped with a rubber panel gasket (50 to 60 Sh). To assure the IP65 and NEMA 4 protection, insert the panel gasket between the instrument and the panel as shown below.

Install the instrument as follows:

- 1) Insert the instrument in the gasket.
- 2) Insert the instrument in the panel cutout.
- 3) Pushing the instrument against the panel, insert the mounting bracket.
- 4) Torque the mounting bracket screws between 0.3 and 0.4 Nm (2.66 and 3.54 lbf-in).
- 5) To insure NEMA 4X/IP65 protection, make sure the instrument does not move within the cutout .

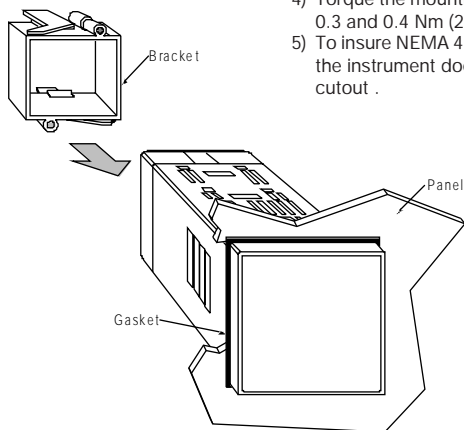

# Mounting Requirements

## Wall or Rail Mount Controller

### WARNING:

- 1) The correct functionality of these instruments is guaranteed only if transport, storage, installation, wiring, working condition and maintenance are executed in compliance with this manual.
- 2) The protection degree of these instruments is equal to IP 20 (according to IEC529) and they are connected to dangerous power lines, for these reasons:
  - installation, wiring and maintenance must be executed by qualified personnel;
  - all warnings contained in this manual must be complied.
- 3) The safety requirements for Permanently Connected Equipment say:
  - a switch or circuit-breaker shall be included in the building installation;
  - It shall be in close proximity to the equipment and easy to reach for the operator;
  - it shall be marked as the disconnecting device for the equipment.

NOTE: a single switch or circuit-breaker can drive more than one instrument.
- 4) Before to executing any operation on the connections, disconnect the instrument from the power line by the circuit breaker.

### GENERAL ASSEMBLING INFORMATION

Select a cleaned location, easy to reach, where minimum vibrations are present and the ambient temperature is within 0 and 50 °C (32 and 122 °F). These instruments can be mounted either on wall or DIN rail.

### RAIL MOUNTING

Use DIN rail in accordance with EN 50 022 (35 x 7.5 mm or 35 x 15 mm).

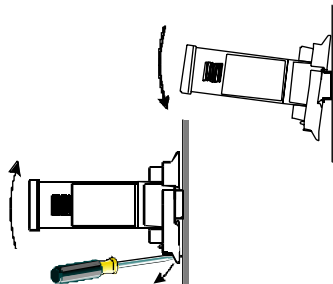

### WALL MOUNTING

For wall mounting, use the (A) holes.

In this case it is advisable to use four M4 screws with a torque of 1Nm.

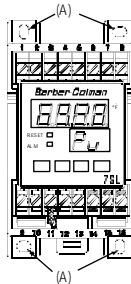

# Dimensions and Rear Terminal Blocks

## Panel Mount Controllers

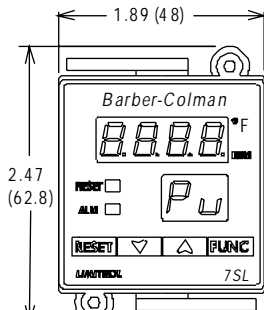

Without RS-485

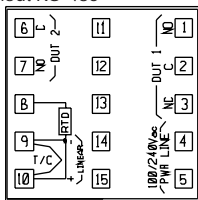

With RS-485

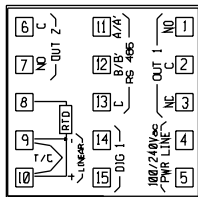

Dimensions shown in inches;  
millimeters in parenthesis

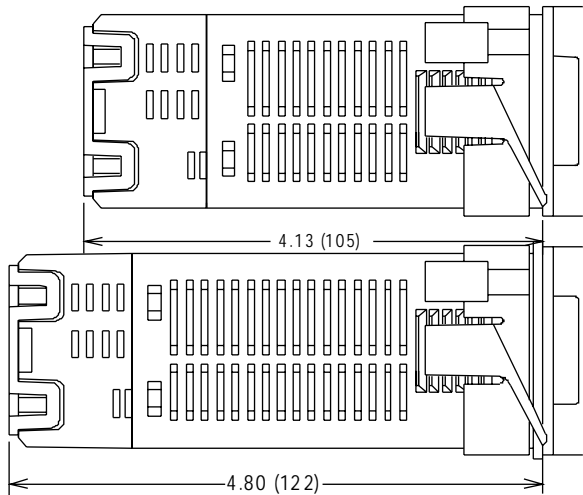
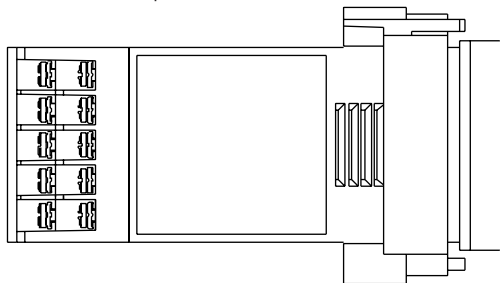

# PANEL CUTOUT

Dimensions shown in inches;  
millimeters in parentheses

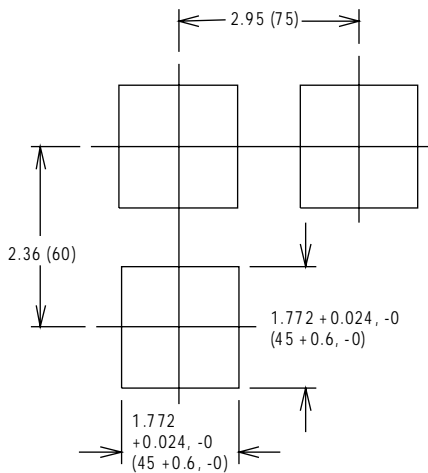



# Dimensions

## Wall or Rail Mount Controller

Dimensions shown in inches;  
millimeters in parentheses

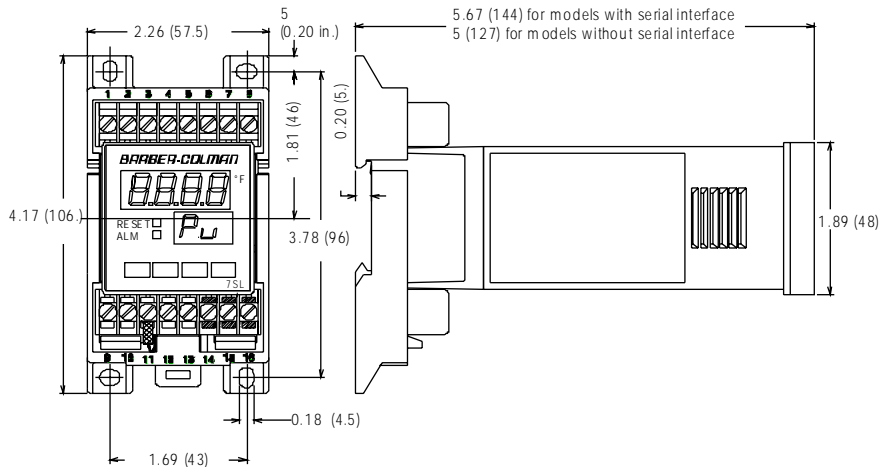

## Wiring Guidelines

### Panel Mount Controllers

#### A) Measuring Inputs

NOTE: Any external components (like Zener diodes, etc.) connected between sensor and input terminals may cause errors in measurement due to excessive and/or not balanced line resistance or possible leakage currents.

#### TC Input

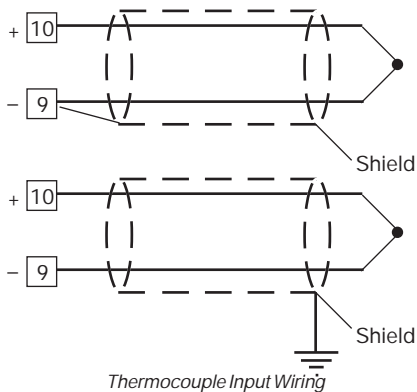

#### NOTE:

- 1) Do not run input wires with power cables.
- 2) For TC wiring use proper compensating cable, preferably shielded (see Appendix B).
- 3) Shielded cable should be grounded at one end only.

#### RTD INPUT -- Panel Mount Controller

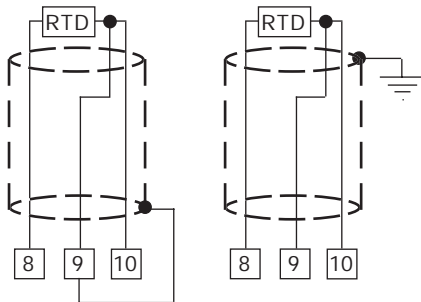

*RTD Input Wiring*

#### NOTE:

- 1) Don't run input wires with power cables.
- 2) Pay attention to the line resistance; a high line resistance may cause measurement errors.
- 3) When shielded cable is used, it should be grounded at one side only to avoid ground loop currents.
- 4) Resistance of the 3 wires must be the same.

#### LINEAR INPUT - Panel Mount Controller

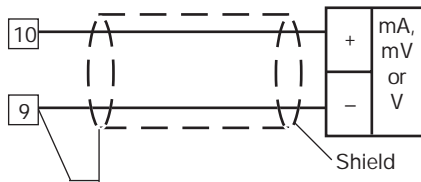

*mA, mV, and V Inputs Wiring*

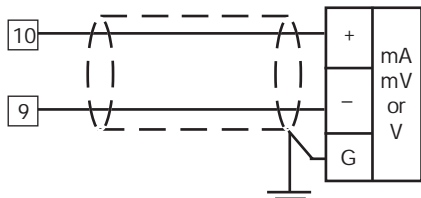

*mA, mV and V Inputs Wiring*

**NOTE:**

- 1) Don't run input wires together with power cables.
- 2) Pay attention to the line resistance; a high line resistance may cause measurement errors.
- 3) When shielded cable is used, it should be grounded at one side only to avoid ground loop currents.
- 4) The input impedance is equal to:  
 Less than 5  $\Omega$  for 20 mA dc input  
 Greater than 1 M $\Omega$  for 60 mV dc input  
 Greater than 400 K $\Omega$  for 5 V dc and 10 V dc input

**B) Logic Input - Panel Mount Controller**  
 Logic input

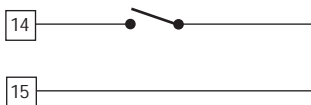

This input is used for remote acknowledgement (reset).

**Safety note:**

- Do not run logic input wiring with AC power cables.

- Use an external dry contact capable of switching 0.5 mA, 5 Vdc.
- The instrument needs 100 ms to recognize a contact status variation.
- The logic inputs are NOT isolated from the measuring input.

**C.1) Relay Outputs - Panel Mount Controller**

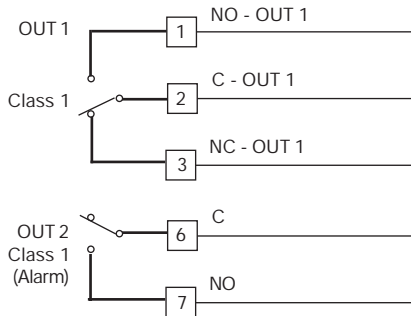

The OUT 1 contact rating is 3A/250V AC on resistive load.

The OUT 2 contact rating is 2A/250V AC on resistive load.

The number of operations is  $1 \times 10^6$  at specified rating.

- NOTES**
- 1) To avoid electric shock, connect power line at the end of the wiring procedure.
  - 2) For power connections use No 16 AWG or larger wires rated for at least 75 °C.
  - 3) Use copper conductors only.
  - 4) Don't run input wires with power cables.

All relay contacts are protected by varistor against inductive load with inductive component up to 0.5 A.

The following recommendations avoid serious problems which may occur, when relay outputs are used with inductive loads.

### C.2) Inductive Loads

High voltage transients may occur switching inductive loads.

Through the internal contacts these transients may introduce disturbances which can affect the performance of the instrument.

For all the outputs, the internal protection (varistor) assures a correct protection up to 0.5 A of inductive component.

The same problem may occur when a switch is used in series with the internal contacts as shown below:

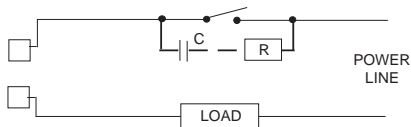

*External Switch in Series with Internal Contact*

In this case it is recommended to install an additional RC network across the external contact as shown above.

The value of capacitor (C) and resistor (R) are shown in the following table.

LOAD (mA)	C (μF)	R (Ω)	P. (W)	OPERATING VOLTAGE
<40 mA	0.047	100	1/2	260 V AC
<150 mA	0.1	22	2	260 V AC
<0.5 A	0.33	47	2	260 V AC

Anyway the cable involved in relay output wiring must be as far away as possible from input or communication cables.

### D) Serial Interface Panel Mounted Controllers

#### SERIAL INTERFACE

For units built with optional RS-485 communication

RS-485 interface allows to connect up to 30 devices with one remote master unit.

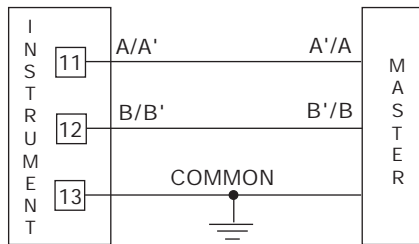

*RS-485 Wiring*

The cable length must not exceed 9/10 mile (1.5 km) at 9600 baud.

NOTE: The following report describes the signal sense of the voltage appearing across the interconnection cable as defined by EIA for RS-485.

- The "A" terminal of the generator shall be negative with respect to the "B" terminal for a binary 1 (MARK or OFF) state.
- The "A" terminal of the generator shall be positive with respect to the "B" terminal for a binary 0 (SPACE or ON)

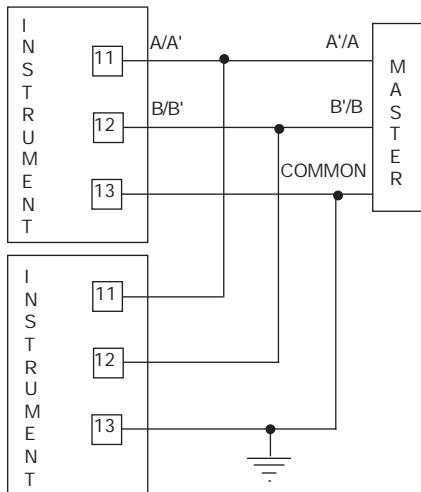

### RS-485 Wiring for Multiple Instruments

E) Power Line and Grounding -  
Panel Mount Controllers

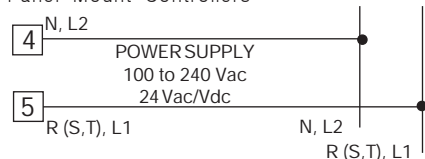

NOTE:

- 1) Before connecting the power line, check that the voltage is correct (see Model Number).
- 2) For supply connections use 16 AWG or larger wires rated for at least 75 °C.

- 3) Use copper conductors only.
- 4) Do not run input wires with power cables.
- 5) Polarity does not matter for 24 Vdc wiring.
- 6) The power supply input is NOT fuse protected.

Please provide it externally.

Power supply	Type	Current	Voltage
24 VAC/DC	T	500 mA	250 V
100/240 V AC	T	125 mA	250 V

When fuse is damaged, it is advisable to verify the power supply circuit, so that it is necessary to send back the instrument to your supplier.

- 7) Safety requirements for permanently connected equipment:
  - Include a switch or circuit-breaker in the installation.
  - Place switch in close proximity to the equipment and within easy reach of the operator.
  - Mark the switch as the disconnecting device for the equipment.

NOTE: A single switch or circuit-breaker can drive more than one instrument.

- 8) When the NEUTRAL line is present, connect it to terminal 4.
- 9) To avoid shock and possible instrument damage, connect power last.

## Wiring Guidelines

### Wall or Rail Mount Controller

Connections have to be executed when the instrument is placed in its proper location.

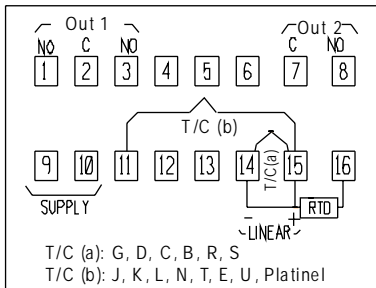

*Model 7SL Terminal Block  
Without RS-485 or Logic Input*

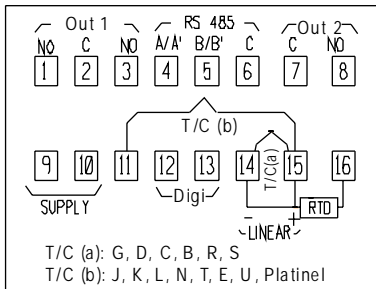

*Model 7SL Terminal Block  
With RS-485 and Logic Input*

## MEASURING INPUTS

### NOTES:

- Any external components (like zener barriers etc.) connected between sensor and input terminals may cause measurement errors due to excessive and/or not balanced line resistance or possible leakage currents.
- The input accuracy is equal to  $\pm 0.2$  % f.s.v. (\*\*)  $\pm 1$  dgt. @ 25 degrees Celsius of ambient temperature. (\*\*) For TC input, the f.s.v. should be referenced to the higher f.s.v. of the TC selected.

### TC INPUT

TC Type G, D, C, B, R and S  
(Wall & Rail Mount)

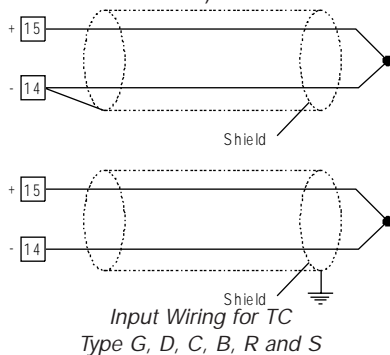

## TC Type J, K, L, N, T, E, U and Platinel (Wall & Rail Mount)

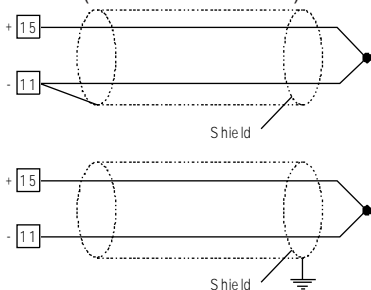

### *Input Wiring for*

*TC Types J, K, L, N, T, E, U and Platinel*

#### NOTE:

- 1) Do not run input wires with power cables.
- 2) For T/C wiring use proper compensating cable, preferably shielded (see appendix B).
- 3) When a shielded cable is used, it should be connected to one side only.

## RTD INPUT (Wall & Rail Mount)

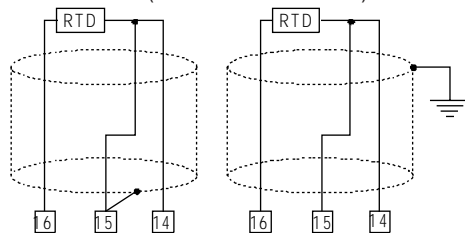

### *RTD Input Wiring*

#### NOTE:

- 1) Don't run input wires together with power cables.
- 2) Pay attention to the line resistance; an high line resistance may cause measurement errors.
- 3) When shielded cable is used, it should be grounded at one side only to avoid ground loop currents.
- 4) The resistance of the 3 wires must be the same.

## LINEAR INPUT(Wall & Rail Mount)

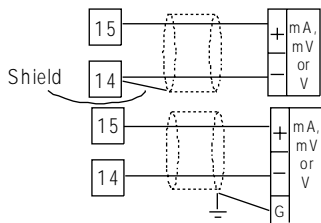

*mA, mV and V Inputs Wiring*

### NOTE:

- 1) Do not run input wires together with power cables.
- 2) Pay attention to the line resistance; a high line resistance may cause measurement errors.
- 3) When shielded cable is used, it should be grounded at one side only to avoid ground loop currents.
- 4) The input impedance is equal to:
  - < 5 ohms for 20 mA<sub>dc</sub> input
  - > 1 megohms for 60 mV<sub>dc</sub> input
  - > 400 kilo-ohms for 5 V<sub>dc</sub> and 10 V<sub>dc</sub> input

## LOGIC INPUT (Wall & Rail Mount Controllers with Serial Input)

This input is used for remote alarm reset when manual reset of alarm is selected.

### SAFETY NOTES:

- 1) Do not run logic input wiring together with power cables.
- 2) Use an external dry contact capable of switching 0.5 mA, 5 V DC.
- 3) The instrument needs 100 ms to recognize a contact status variation.
- 4) The logic input is NOT isolated by the measuring input.

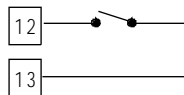

*Logic Input Wiring*



## RELAY OUTPUTS (Wall & Rail Mount)

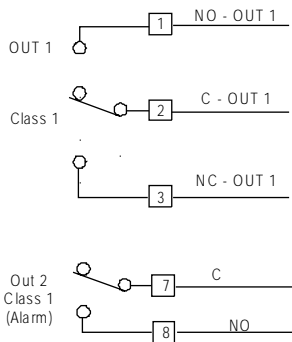

*Relay Outputs Wiring*

The contact rating of OUT 1 is 3A/250V ac on resistive load. Contact rating of OUT 2 is 2A/250 Vac on resistive load. The number of operations is  $1 \times 10^5$  at specified rating.

### NOTES

- 1) To avoid electric shock, connect power line at the end of the wiring procedure.
- 2) For power connections use No 16 AWG or larger wires rated for at least 75 °C.
- 3) Use copper conductors only.
- 4) Do not run input wires with power cables.

All relay contacts are protected by varistor against inductive load with inductive component up to 0.5 A.

The following are recommendations avoid serious problems which may occur, when using relay output for driving inductive loads.

## INDUCTIVE LOADS (Wall & Rail Mount)

High voltage transients may occur switching inductive loads.

Through the internal contacts these transients may introduce disturbances which can affect the instrument performance.

For all outputs, the internal protection (varistor) assures a correct protection up to 0.5 A of inductive component.

The same problems may occur when a switch is used in series with the internal contacts as shown:

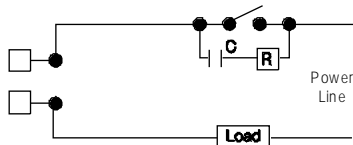

*External Switch in Series  
with Internal Contact*

In this case it is recommended to install an additional RC network across the external contact as shown. The value of capacitor (C) and resistor (R) are shown in the following table:

Load	C( $\mu$ F)	R(ohms)	P(W)	Op. V
<40 mA	0.047	100	1/2	260 Vac
<150 mA	0.1	22	2	260 Vac
<0.5 A	0.33	47	2	260 Vac

Anyway the cable involved in relay output wiring must be as far away as possible from input or communication cables.

## SERIAL INTERFACE (Wall & Rail Mount)

RS-485 interface allows to connect up to 30 devices with one remote master unit.

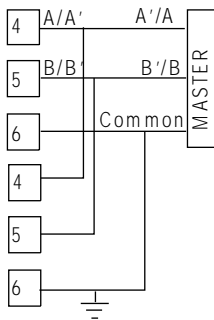
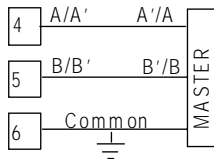

### RS-485 Wiring

The cable length must not exceed 9/10 mile (1.5 km) at 9600 BAUD.

NOTE: The following report describes the signal sense of the voltage appearing across the interconnection cable as defined by EIA for RS-485.

- a) The "A" terminal of the generator shall be negative with respect to the "B" terminal for a binary 1 (MARK or OFF) state.
- b) The "A" terminal of the generator shall be positive with respect to the "B" terminal for a binary 0 (SPACE or ON)

### POWER LINE WIRING (Wall & Rail Mount)

N, L2

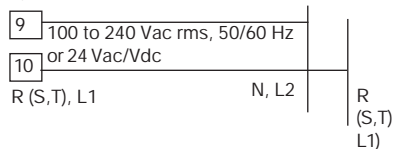

*Power Line Wiring*

#### NOTES:

- 1) Before connecting the instrument to the power line, make sure that line voltage corresponds to the description on the identification label.
- 2) To avoid electric shock, connect power line at the end of the wiring procedure.
- 3) For supply connections use No 16 AWG or larger wires rated for at last 75 °C.
- 4) Use copper conductors only.

- 5) Do not run input wires with power cables.
- 6) For 24 Vdc the polarity is not a care condition.
- 7) The power supply input is *not* fuse protected. Please, provide it externally.

<u>Pwr Supply</u>	<u>Type</u>	<u>Current</u>	<u>Voltage</u>
24 Vac/ Vdc	T	500 mA	250 V
100/240 Vac	T	125 mA	250 V

When fuse fails, check instrument for component damage. It is advisable to verify the power supply circuit, so it may be necessary to send the instrument back to your supplier.

- 8) The safety requirements for Permanently Connected Equipment say: a switch or circuit-breaker shall be included in the building installation; it shall be in close proximity to the equipment and within easy reach of the operator; it shall be marked as the disconnecting device for the equipment.  
NOTE: a single switch or circuit-breaker can drive more than one instrument.
- 9) When neutral line is present, connect it to terminal 9.

## Preliminary Hardware Settings

- 1) Remove the instrument from its case.
- 2) Set J106 according to the desired input type as shown in the following figure.

INPUT TYPE	J106			
	1-2	3-4	5-6	7-8
TC-RTD	close	open	open	open
60 mV	close	open	open	open
5 V	open	close	open	open
10 V	open	open	close	open
20 mA	open	open	open	close

Limitrol without RS-485

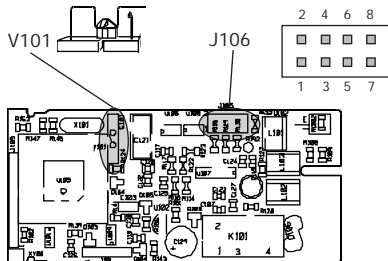

Limitrol with RS-485

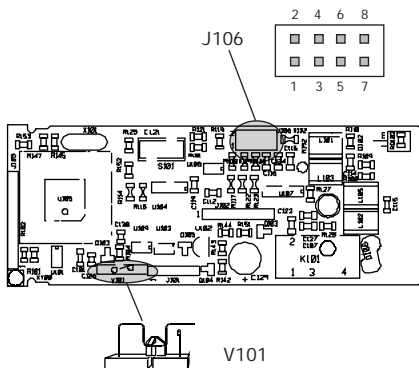

## Configuration Procedure

### CONFIGURATION KEY FUNCTIONS

**RESET** In Configuration Mode, it is used only to scroll back parameters without to memorize a new parameter value.

▼ Used in Configuration Mode to decrease the parameter value.

▲ Used in Configuration Mode to increase the parameter value.

**FUNC** Used to memorize the new parameter value and go to the next parameter.

▼ + ▲ Loads the default parameters.

▲ + FUNC or ▼ + FUNC

Increases/decreases values at a higher rate when modifying parameters.

▲ + RESET or ▼ + RESET

Jumps to the Maximum or Minimum parameter value when modifying parameters.

### CONFIGURATION PROCEDURE

- 1) Remove the instrument from its case.
- 2) Open switch V101 (See illustrations under "Preliminary Hardware Settings.")
- 3) Re-insert the instrument in its case.
- 4) Switch on power to the instrument.

The upper display will show CONf.

NOTE : If "CAL" indication will be displayed, press immediately the ▲ pushbutton and return to the configuration procedure.

- 5) Press the "▼" key and the lower display will show the firmware version.

Press the "FUNC" key to start the configuration procedure with the first parameter (L1).

The following is a complete list of parameters. The lower display will show the parameter code (L1 to d1) and the upper display will show the selection code or numerical value. No timeout is applied in the configuration mode.

L1 = Serial Interface Protocol

(Skipped if option is not available.)

OFF = No serial interface

nbUS = Modbus

jbUS = Jbus

L2 = Serial Link Device Address

(Skipped if option is not available or L1 = OFF)

From 1 to 255

NOTE: EIA standard allows no more than 31 device connected by one RS-485.

L3 = Baud Rate for Serial Link

(Skipped if option is not available or L1 = OFF)

Set value from 600 to 19200 baud.

(19200 baud is shown on display as 1920)

L4 = Byte Format for Serial Link

(Skipped if option is not available or L1 = OFF)

8E = 8 bits + even parity

8O = 8 bits + odd parity

8 = 8 bits without parity

r1 = Input Type	and Range	Value	
0 = TC J	From -100 to 1000	°C	
1 = TC K	From -100 to 1370	°C	
2 = TC T	From -200 to 400	°C	
3 = TC E	From -100 to 800	°C	
4 = TC N	From -100 to 1400	°C	
5 = TC S	From -50 to 1760	°C	
6 = TC R	From -50 to 1760	°C	
7 = TC B	From 0 to 1820	°C	
8 = TC L	From -100 to 900	°C	
9 = TC U	From -200 to 600	°C	
10 = TC G	From 0 to 2300	°C	
11 = TC D	From 0 to 2300	°C	
12 = TC C	From 0 to 2300	°C	
13 = TC Plat. II	From -100 to 1400	°C	
14 = RTD Pt 100	From -200 to 850	°C	
15 = Linear	From 0 to 60	mV	
16 = Linear	From 12 to 60	mV	
17 = Linear	From 0 to 20	mA	
18 = Linear	From 4 to 20	mA	
19 = Linear	From 0 to 5	V	
20 = Linear	From 1 to 5	V	
21 = Linear	From 0 to 10	V	
22 = Linear	From 2 to 10	V	
23 = TC J	From -150 to 1830	°F	
24 = TC K	From -150 to 2500	°F	
25 = TC T	From -330 to 750	°F	
26 = TC E	From -150 to 1470	°F	
27 = TC N	From -150 to 2550	°F	
28 = TC S	From -60 to 3200	°F	
29 = TC R	From -60 to 3200	°F	
30 = TC B	From 32 to 3300	°F	
31 = TC L	From -150 to 1650	°F	
32 = TC U	From -330 to 1110	°F	
33 = TC G	From 0 to 4170	°F	
34 = TC D	From 0 to 4170	°F	
35 = TC C	From 0 to 4170	°F	
36 = TC Plat. II	From -150 to 2550	°F	
37 = RTD Pt100	From -330 to 1560	°F	

r2 = Decimal Point Position  
(Available only for linear range r1 = 15 to 22)

\_\_\_\_\_ = No decimal  
 \_\_\_\_\_. = One decimal place  
 \_\_\_\_\_. = Two decimal places  
 \_\_\_\_\_. = Three decimal places

r3 = Initial value of the readout scale  
(Available only for linear range r1 = 15 to 22)  
 Range: From -1999 to 9999

r4 = final value of the readout scale  
(Available only for linear range r1 = 15 to 22)  
 Range: From -1999 to 9999

r5 = Offset Adjustment  
 Range: From -500 to 500  
 Offset value algebraically added to the measured value.

r6 = Time constant of the filter applied to the displayed value  
 Range: From 0 (filter OFF) to 8 seconds.  
 (First order filter with selected time constant.)

r7 = Alarm action on input fault.  
 When the instrument detects an input failure condition, the alarm will operate as in presence of:  
 uP = as in presence of the full scale value.  
 doun = as in presence of the initial scale value.

C1 = Type of limit action  
 Hi. = High limit (for heating process)  
 Lo. = Low limit (for cooling process)  
 Hi.Lo = High and low limit (for special process)

C2 = Rearming Mode

O = Acknowledgements rearm (reset) the limiter (and restart the process) only if the condition which generated the shutdown status no longer exists (points A and C of the Example 1). It do not generate any effect if the condition which generated the shutdown status still exists (point B of the Example 1).

I = Acknowledgements enable the automatic rearmament (reset) of the limiter if the condition which generated the shutdown status still exists (point B of the Example 2). (The instrument rearms (reset) automatically when the condition which generated the shutdown status no longer exists).

#### Notes about limiter function

The relay of the output 1 operates in fail-safe mode (relay de-energized during shutdown condition) and latching mode.

The OUT 1 turns OFF when:

- C1 = Hi and the measured value is greater than limiter threshold ["Su" parameter (see Operative parameters)] or
- C1 = LO and the measured value is less than limiter threshold ["Su" parameter (see Operative parameters)] or
- C1 = HILO and the measured value is greater than "Su" parameter (see Operative parameters) or less than "S1" parameter (see Operative parameters).

The Out 1 remains OFF until the condition which generated the shutdown, no longer exists and the acknowledge action has been performed.

The upper display flashes during a shutdown and returns to a steady display when the shutdown condition no longer exists.

When C2 = 0 and OUT 1 is OFF, RESET LED is ON. When C2 = 1 one of the following condition may occur:

- if no acknowledgement has been made, OUT 1 is OFF and the RESET LED is flashing;
- if the acknowledgement has been made but the condition which generated the shutdown status still exists, OUT 1 is OFF and the RESET LED is steady ON.

The shutdown condition can be stored in permanent memory (see C4).

Acknowledgment can be performed by pressing the RESET key, by momentarily closing the external dry contact or by a command from the serial link.

The length of the shutdown condition and max/min measured values are stored in memory and available for viewing until the next shutdown condition occurs. These informations are lost at power down. During a shutdown condition the max/min measured values are continuously updated and can be monitored.

Example 1 - C1 = Hi and C2 = O

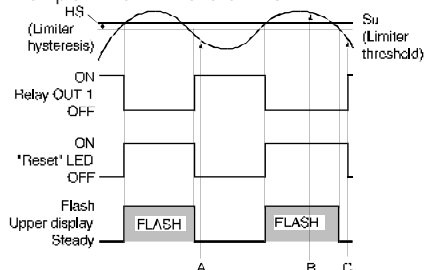

A, B, C = Acknowledgment actions.

NOTE: Acknowledgment B has no effect.

## Example 2 - C1 = Hi and C2 = 1

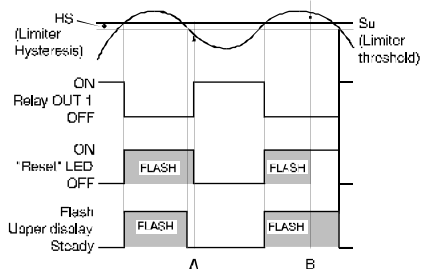

A, B = Acknowledgment actions.

C3 = Rearm at Power-up

Auto = Automatic rearm

$\bar{n}An$  = Manual rearm

C4 = Shutdown memory

0 = The shutdown condition will be saved (at next power up it will be reactivated)

1 = The shutdown condition will be lost in case of power down

C5 = Time Constant of the Filter applied to the Measured Value for Limit Action.

Range: From 0 (filter OFF) to 8 seconds

Note: First order filter with selected time constant.

P1 = Alarm Function

(Skipped when the option is not available)

nonE = Not provided

AL.P = Process alarm

AL.b = Band alarm

AL.d = Deviation alarm

When C1 = Hi.Lo, "AL.b" and "AL.d" are not available.

P2 = Alarm configuration

(Skipped if option is not available or P1 = none)

H.A. = High alarm with automatic reset

L.A. = Low alarm with automatic reset

H.A.Ac = High alarm with automatic reset and "Silence" function.

L.A.Ac = Low alarm with automatic reset and "Silence" function.

H.L. = High alarm with manual reset

L.L. = Low alarm with manual reset

NOTE:

- 1) For band alarm, H.A./H.A.Ac/H.L. signifies outside band alarm, while L.A./L.A.Ac/L.L. signifies inside band alarm.
- 2) The "Silence" function allows the manual reset of the alarm even if the alarm condition is still in progress.

Example for P2 = H.A.

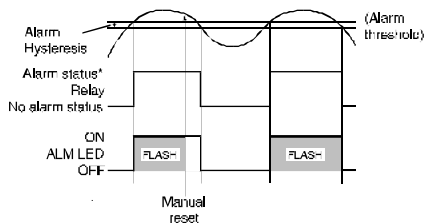

\* Alarm Status: Relay energized (P3 = dir)  
Relay de-energized (P3 = rEV)



Example for P2 = H.A.A.c

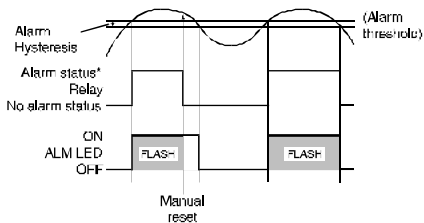

\* Alarm Status: Relay energized (P3 = dir)  
Relay de-energized (P3 =rEV)

Example for P2 = H.L.

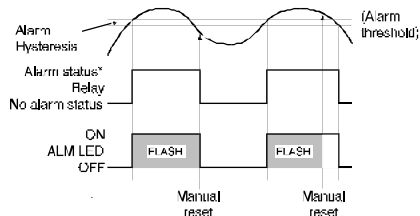

\* Alarm Status: Relay energized (P3 = dir)  
Relay de-energized (P3 =rEV)

P3 = Alarm Action

(Skipped if option not is available or P1 = none)

dir = Direct action  
(Relay energized in alarm condition)

rEV = Reverse action  
(Relay energized in non-alarm condition)

P4 = Alarm Standby (mask) Function

(Skipped if option is not available or P1 = none)

OFF = Standby function disabled

On = Standby function enabled

If the alarm is programmed as band or deviation, this function masks the alarm condition at start up and after a "Su" (limit threshold) chngement until the process variable reaches the alarm threshold, plus or minus hysteresis. This standby function masks a Process Alarm condition at start up until the process variable reaches the alarm threshold plus or minus hysteresis.

PF = Time Constant of the Filter applied to the Measured Value for Alarm Action

(Skipped if option is not available or P1 = none)

Range: From 0 (filter OFF) to 8 seconds

(First order filter with selected time constant.)

n1 = Safety Lock  
0 = UNLOCKed. The device is always UNLOCKed and all parameters can be modified.  
1 = LOCKed. The device is always LOCKed and no parameters can be modified  
From 2 to 9999 = This number is a password, to be used in run time (see "nn"), to LOCK/ UNLOCK the device.

t1 = Timeout Selection  
tn10 = 10 second timeout  
tn30 = 30 second timeout

d1 = Digital Input (contact closure)  
(This is a read only parameter)  
Enb = Digital input enabled  
dIS = Digital input disabled  
(The digital input is used as a remote Acknowledgment .)

The configuration procedure is now complete.  
The display will show "CONF".

## Operating Mode

- 1) Remove the instrument from its case.
- 2) Set switch V101 to the closed position. (See illustrations at "Preliminary Hardware Settings").
- 3) Re-insert the instrument in its case.
- 4) Switch on the instrument.

### Normal Display Mode

On powerup the device starts in the "Normal Display Mode."

By pressing the ▲ or ▼ key, it is possible to change the displayed information; therefore, one of the following display modes can be selected:

- 1) The upper display shows the measured value while the lower display shows the "Pu" (Process variable).  
If this display was active at power down, it will be active at powerup.
- 2) The upper display shows the limiter threshold while the lower display shows "Su." If this display was active at power down, it will be active at powerup.
- 3) The upper display shows the second limiter threshold while the lower display shows "S1." This information is available only if C1 = Hi.Lo. If this display was active at power down, it will be active at powerup.
- 4) The upper display shows the total time (hh.mm) of the last shutdown condition while the lower displays shows "t." If no shutdown condition was detected, the upper display will show "- - - -". The information is lost at power down and at powerup the device will display the process variable.

- 5) The upper display shows the maximum measured value detected during the last shutdown condition while the lower display shows "Ph.". If no shutdown condition was detected, the upper display will show "- - - -". This information is not available if C1 = Hi.Lo. The information is lost at power down and at powerup the device will display the process variable.

NOTE: When the shutdown condition was generated by an input fault condition, the upper display will indicate  $\bar{m}$ .Err .

- 6) The upper display shows the minimum measured value detected during the last shutdown condition while the lower display shows "PL." If no shutdown condition was detected, the upper display will show "- - - -". This information is not available if C1 = Hi. The information is lost at power down and at powerup the device will display the process variable.

NOTE: When the shutdown condition was generated by an input fault condition, the upper display will indicate  $\bar{m}$ .Err

If, at power off, the device was in shutdown condition and shutdown memory function is selected (C4 = 0), and/or it was programmed for manual reset at startup (C3 = 1), then at the next power up the lower display will be flashing.

## Indicators

"RESET" = Indicates control output 1 status as follows:

- a) When C2 parameter has been configured equal to 0,  
LED ON when Output 1 is OFF  
LED OFF when Output 1 is ON
- b) When C2 parameter has been configured equal to 1,  
LED flashes when Output 1 is OFF  
LED ON when Output 1 is OFF and acknowledged  
LED OFF when Output is ON

"ALM" = Indicates alarm status as follows:

- Flashes when alarm is ON
- ON when alarm has been reset but the alarm condition is still present.
- OFF when alarm is OFF

"REM" = Indicates the remote status of the instrument.

- Flashes when instrument is in remote mode.
- OFF when instrument is in local mode.

## Key Functions in Normal Display Mode

"FUNC" = By pressing it, the display changes from "Normal Display Mode" to "Operative Parameter Display Mode."

- = Pressing it for more than ten seconds initiates the Lamp Test. During the Lamp Test the device functions normally while all display segments and LED's are lit with a 50% duty cycle. No timeout is applied to a lamp test.

Press the "FUNC" key again to end the Lamp Test.

"▲" or "▼" = By pressing these keys it is possible to change the displayed information. See "Normal Display Mode."

"RESET" = Press and hold for 1 second to rearm (reset) the limiter.

▲ + FUNC or ▼ + FUNC  
Increases/decreases values at a higher rate when modifying parameters.

▲ + RESET or ▼ + RESET  
Jumps to the Maximum or Minimum parameter value when modifying parameters.

## Operative Parameter Display Mode

The "FUNC" key initiates the Operative Parameter Display Mode when pressed for less than 10 seconds in the "Normal Display Mode."

The lower display shows the parameter code while the upper display shows the parameter value or status. The value of the selected parameter can be modified with the ▲ and ▼ keys.

Press the "FUNC" key again to store the new value and advance to the next parameter.

If no keys are pressed within the timeout period (see t1), the instrument will automatically return to the "Normal Display Mode" in the previous display and any modification of the last displayed parameter will be lost.

All parameters (except  $R_{T}$ ) can be modified only when the device is UNLOCKED.

The LOCK/UNLOCK status can be selected in configuration using "n1" parameter or during the operating mode with the "nn" parameter (password).

To switch from LOCKED to UNLOCKED, assign to the "nn" parameter a value equal to the "n1" parameter setting. To switch from UNLOCKED to LOCKED, assign to the "nn" parameter any number other than the n1 parameter setting. When the device is in remote mode (the serial link controls the device) no parameters can be modified.

### Key Functions in Operative Parameter Display Mode

- FUNC** = Pressing the "FUNC" key, the instrument stores the new setting (if changed) and goes to the next parameter.
- ▲ or ▼** = Changes the setting of the selected parameter.
- RESET** = Press and hold for more than 1 second for limiter rearmament.

### OPERATING PARAMETERS

Some of the following parameters may not appear, depending on the configuration.

#### Lower Description Display

- R5** Manual reset of the alarm.  
(Available only if P1 = AL.p, AL.b or AL.d)  
ON = Starts the manual reset of the alarm  
OFF = Do not start the alarm reset.  
Select ON and press the FUNC key in order to reset the alarm.  
After a manual reset of the alarm the instrument returns in Normal Display Mode.

- nn** Software Key  
(Skipped if n1 = 0 or 1)  
ON = the device is LOCKED.  
OFF = the device is UNLOCKED.  
When it is desired to switch from LOCK to UNLOCK condition, set a value equal to "n1" parameter.  
When it is desired to switch from UNLOCK to LOCK condition, set a value different from "n1" parameter.
- Su** Limiter Threshold  
Range: Span limits (From "S1" to full scale value when C1 = Hi.Lo)
- S1** Second Limiter Threshold  
(Available when C1 = Hi.Lo)  
Range: From initial scale value to "Su"
- HS** Limiter Hysteresis  
Range: From 0.1% to 10.0% of the input span or 1 LSD
- AL** Alarm Threshold (optional)  
(Available only if the option is fitted and P1 = AL.P, AL.b or AL.d.)  
Ranges:  
span limits for process alarm (P1 = AL.P) from 0 to 500 for band alarm (P1 = AL.b) from -500 to 500 for deviation alarm (P1 = AL.d)
- HA** Alarm Hysteresis (optional)  
(Available only if the option is fitted and P1 = AL.P, AL.b or AL.d)  
Range: From 0.1% to 10.0% of the input span or 1 LSD.

## Limiter function

The relay of the output 1 operates in fail-safe mode (relay de-energized during shutdown condition) and latching mode.

The OUT 1 turns OFF when:

- The instrument is configured as a high limiter ( $C1 = Hi$ ) and the measured value is greater than limiter threshold ["Su" parameter (see Operative parameters)] or
- The instrument is configured as a low limiter ( $C1 = LO$ ) and the measured value is less than limiter threshold ["Su" parameter (see Operative parameters)] or
- The instrument is configured as a high/low limiter ( $C1 = HiLO$ ) and the measured value is greater than "Su" parameter (see Operative parameters) or less than "S1" parameter (see Operative parameters").

The Out 1 remains OFF until the condition which generated the shutdown, no longer exists and the acknowledge action has been performed.

The upper display flashes during a shutdown and returns to a steady display when the shutdown condition no longer exists.

When the OUT 1 is OFF the RESET LED is ON [if the selected rearming mode is equal to 0 ( $C2 = 0$ )] or flashes [if the selected rearming mode is equal to 1 ( $C2 = 1$ )].

When the selected rearming mode is equal to 1 ( $C2 = 1$ ) the RESET LED is steady ON when OUT 1 is OFF and acknowledged.

The shutdown condition can be stored in permanent memory (see C4).

Acknowledgment can be performed by pressing the RESET key, by momentarily closing the external dry

contact or by a command from the serial link. The length of the shutdown condition and max/min measured values are stored in memory and available for viewing (see "Normal Display Mode") until the next shutdown condition occurs. These informations are lost at power down.

During a shutdown condition the max/min measured values are continuously updated and can be monitored.

Example 1 -  $C1 = Hi$  and  $C2 = 0$

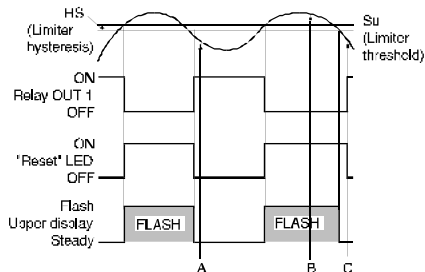

Example 2 -  $C1 = Hi$  and  $C2 = 1$

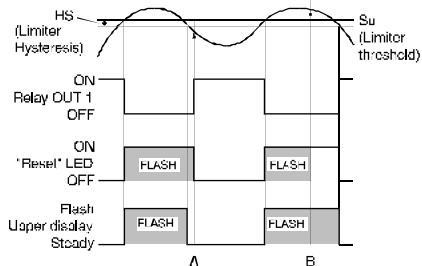

## Alarm functions

(Skipped if option is not available or P1 = none)

The alarm can be programmed as:

- process alarm
- band alarm
- deviation alarm.

Band and deviation alarms are referred to the limiter threshold and are possible only if an high limiter or a low limiter function has been selected.

For all the alarm types, it is possible to select automatic or manual reset or the "Silence" function.

The "Silence" function is a typical function of the alarm annunciators (see ISA "Alarm annunciator operational sequence") and it is usually applied to audible alarm indications (horn). This function allows the manual reset of the alarm even if the alarm condition is still in progress.

It is also possible to assign to the alarm a stand by (mask) function.

If the alarm is programmed as band or deviation alarm, this function masks the alarm condition after a safety threshold change or at the instrument start-up until process variable reaches the alarm threshold plus or minus hysteresis. If the alarm is programmed as a process alarm, this function masks the alarm condition at instrument start-up until process variable reaches the alarm threshold plus or minus hysteresis.

Graphic example of the alarm behaviour are shown at pages 12 and 13.

## Serial Link (optional)

The device can be connected to a host computer via serial link.

The host can put the device in LOCAL (parameters are controlled via keyboard) or in REMOTE (functions and parameters are controlled via serial link). REMOTE is shown by the decimal point to the left of "REM" which is on the right side of the numeric display.

Via serial link it is possible to read and/or to modify all the operative and configuration parameters. The following conditions must apply to implement this function:

- 1) Configure parameters L1 through L4 with the front keyboard
- 2) The device must be in the Operating mode.

## Error Messages

### Overrange, Underrange and Sensor Break Indications

This device detects input fault conditions.

(OVERRANGE, UNDERRANGE OR SENSOR BREAK). When the process variable exceeds the span limits an OVERRANGE condition will appear as:

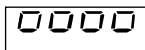

An UNDERRANGE condition will appear as:

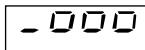

A sensor break is signaled as "OPEN". On the mA/V input, a sensor break can be detected only when the range selected has a zero elevation (4/20 mA, 12/60 mV, 1/5 V or 2/10 V.)

On the RTD input "shrt" is signalled when input resistance is less than 15  $\Omega$  (short circuit sensor detection).

This device detects reference junction errors or errors on the internal autozero measurement. When a fault is detected the output goes OFF and the alarm assumes an upscale/downscale reading in accordance with r7.

## Error Messages

On powerup, the instrument performs a self-diagnostic test. When an error is detected, the lower display shows an "Er" indication while the upper display shows the code of the detected error.

### Error List

100	Error in EEPROM writing
150	Short circuit on CPU's outputs
200	Error on "protect register" in EEPROM
XXX	Configuration parameter error.
301	Error on calibration of selected input.
307	rj input calibration error.
400	Error on operative parameters.
500	Error on autozero measurement.
502	Error on reference junction measurement.
510	Error during calibration procedure.

### Dealing with Error Messages

- 1) When a configuration parameter error is detected, repeat the configuration procedure of that specific parameter.
- 2) If an error 400 is detected, simultaneously press the ▼ and ▲ keys to load the default parameters and then repeat the control parameter setup.
- 3) For all other errors, contact your Service Representative.



## General Specifications

Case: Polycarbonate grey case

Self extinguishing degree: V-0 according to UL.

Front protection - designed and tested for IP 65 (\*) and NEMA 4X (\*) for indoor locations (when panel gasket is installed).

(\*) Test were performed in accordance with IEC 529, CEI 70-1 and NEMA 250-1991 STD.

Installation: panel mounting.

Rear terminal board: 15 screw terminals (screw M3, for cables from  $\varnothing$  0.25 to  $\varnothing$  2.5 mm<sup>2</sup> or from AWG 22 to AWG 14 ), connection diagram and safety rear cover.

Dimensions: 48 x 48 mm (according to DIN 43700); depth

- 122 mm for models with RS-485.

- 105 mm for models without RS-485

Weight: 250 g. max. (8.75 oz.).

Power supply : (switching mode) from 100 to 240 V AC. 50/60 Hz (+10 % to -15 % of the nominal value) or

24 V DC/AC ( $\pm$ 10 % of the nominal value).

Power consumption: 8 VA.

Insulation resistance: > 100 M $\Omega$  according to IEC 1010-1.

Isolation voltage: 1500 V r.m.s. according to IEC 1010-1.

Common mode rejection ratio:

120 dB @ 50/60 Hz.

Normal mode rejection ratio: 60 dB @ 50/60 Hz.

Electromagnetic compatibility:

This instrument is marked CE.

Therefore, it is conforming to council directive 89/336/EEC (reference harmonized standard EN-50081-2 and EN-50082-2).

Safety requirements:

This instrument is marked CE.

Therefore, it is conforming to council directives 73/23/EEC and 93/68/EEC (reference harmonized standard EN 61010-1).

Installation category: II

D/A conversion: dual slope integration.

Sampling time :

- for linear inputs = 250 ms.

- for TC or RTD inputs = 500 ms.

Display updating time: 500 ms.

Resolution: 30000 counts.

Temperature Drift

- Less than 200 ppm/ $^{\circ}$ C of full span for mV and TC ranges 0, 1, 3, 4, 8, 13, 23, 24, 26, 27, 31, 36 (CJ excluded).

- Less than 300 ppm/ $^{\circ}$ C of full span for mA, V and TC ranges 10, 11, 12, 33, 34, 35 (CJ excluded)

- Less than 400 ppm/ $^{\circ}$ C of full span for RTD and TC range 9, 32 (CJ excluded).

- Less than 500 ppm/ $^{\circ}$ C of full span for TC ranges 2, 5, 6, 25, 28, 29 (CJ excluded).

- Less than 600 ppm/ $^{\circ}$ C of full span for TC ranges 7, 30.

NOTE: Precision and drift guaranteed (for  $T > 300^{\circ}$ C/570 $^{\circ}$ F).

Accuracy:  $\pm$  0.2% f.s.v. @ 25  $^{\circ}$ C (77  $^{\circ}$ F) and nominal power supply voltage.

Operative temperature: from 0 to +50  $^{\circ}$ C (32 to 122  $^{\circ}$ F).

Storage temperature: from -20 to +70  $^{\circ}$ C (-4 to 158  $^{\circ}$ F).

Humidity: from 20% to 85 % RH not condensing.

## INPUTS

### A) THERMOCOUPLE

Type : J, K, T, E, N, S, R, B, L, U, G(W), D(W3), C(W5), Platinel II, °C/°F selectable.

External resistance: 100 Ω max, maximum error 0.1% of span.

Burn out: It is shown as an overrange condition (standard). It is possible to obtain an underrange indication by cut and short.

Cold junction: automatic compensation from 0 to 50 °C.

Cold junction accuracy : 0.1 °C/°C

Input impedance: > 1 MΩ

Calibration : according to IEC 584-1 and DIN 43710 - 1977.

#### STANDARD RANGES TABLE

I/C type	Ranges			
J	0	-100 / 1000 °C	23	-150 / 1830 °F
K	1	-100 / 1370 °C	24	-150 / 2500 °F
T	2	-200 / 400 °C	25	-330 / 750 °F
E	3	-100 / 800 °C	26	-150 / 1470 °F
N	4	-100 / 1400 °C	27	-150 / 2550 °F
S	5	-50 / 1760 °C	28	-60 / 3200 °F
R	6	-50 / 1760 °C	29	-60 / 3200 °F
B	7	0 / 1820 °C	30	32 / 3300 °F
L	8	-100 / 900 °C	31	-150 / 1650 °F
U	9	-200 / 600 °C	32	-330 / 1110 °F
G(W)	10	0 / 2300 °C	33	0 / 4170 °F
D(W3)	11	0 / 2300 °C	34	0 / 4170 °F
C(W5)	12	0 / 2300 °C	35	0 / 4170 °F
P.(*)	13	-100 / 1400 °C	36	-150 / 2550 °F

(\*) P. equal to Platinel II

### B) RTD (Resistance Temperature Detector)

Input: for RTD Pt 100 Ω, 3 wire connection.

Input circuit: current injection.

°C/°F selection: via front pushbuttons or serial link.

Line resistance: automatic compensation up to 20 Ω/wire with no measurable error.

Calibration: according to DIN 43760

Burn out: The instrument detect the open condition of one or more wires. It is able to detect also the short circuit of the sensor.

#### STANDARD RANGES TABLE

Input type	Ranges	
RTD Pt 100 Ω	14	- 200 / 850 °C
DIN 43760	37	- 330 / 1560 °F

### C) LINEAR INPUTS

Read-out: keyboard programmable between -1999 and +9999.

Decimal point: programmable in any position  
Burn out: the instrument shows the burn out condition as an underrange condition for 4-20 mA, 1-5 V and 2-10 V input types.

It shows the burn out condition as an underrange or an overrange condition (selectable by soldering jumper) for 0-60 mV and 12-60 mV input types. No indication are available for 0-20 mA, 0-5 V and 0-10 V input types.

STANDARD RANGES		TABLE	Accuracy
Input type		impedance	
15	0 - 60 mV	> 1 M $\Omega$	0.2 % + 1 digit @ 25°C (77 °F)
16	12 - 60 mV		
17	0 - 20 mA		
18	4 - 20 mA	< 5 $\Omega$	
19	0 - 5 V	> 400 k $\Omega$	
20	1 - 5 V		
21	0 - 10 V	> 400 k $\Omega$	
22	2 - 10 V		

#### D) LOGIC INPUTS

This instrument is provided of 1 logic input used for remote acknowledgement.

#### NOTES

- 1) Use an external dry contact capable of switching 0.5 mA, 5 V DC.
- 2) The instrument needs 100 ms to recognize a contact status variation.
- 3) The logic inputs are NOT isolated by the measuring input.

#### OUTPUTS

Output updating time :

- 250 ms when a linear input is selected
- 500 ms when a TC or RTD input is selected.

#### OUTPUT 1

Type: relay SPDT contact .

Contact rated: 3 A at 250 V AC on resistive load.

Function: Safety limiter output.

Action: reverse (fail-safe).

#### OUTPUT 2

Type: relay SPST contact .

Contact rated: 2 A at 250 V AC on resistive load.

Function: Alarm output

Action: direct/reverse programmable by front keyboard.

#### ALARM

Action: Direct or reverse acting.

Alarm functions: configurable as process alarm, band alarm or deviation alarm.

Alarm reset: automatic reset, manual reset or "Silence" function is programmable.

Stand by (mask) alarm: the alarm can be configured with or without stand by (mask) function.

Process alarm:

Operative mode : High or low programmable.

Threshold: programmable in engineering unit within the readout span.

Hysteresis: programmable from 0.1 % to 10.0 % of the readout span.

#### Band alarm

Operative mode: Inside or outside band programmable.

Threshold: programmable from 0 to 500 units.

Hysteresis : programmable from 0.1 % to 10.0 % of the readout span.

#### Deviation alarm

Operative mode : High or low programmable.

Threshold : programmable from - 500 to +500 units.

Hysteresis : programmable from 0.1 % to 10.0 % of the readout span.

#### SERIAL COMMUNICATION INTERFACE (OPTION)

Type: RS-485

Protocol type: MODBUS or JBUS.

Baud rate: programmable from 600 to 19200 BAUD.

Byte format: 8 bit.

Parity: even, odd or none programmable.

Stop bit: one.

Address: from 1 to 255.

Output voltage levels: according to EIA standard.

## Calibration

Calibration parameters are logically divided into groups of two parameters each – initial scale value and final scale value. A calibration check is provided after entering the values of each group. A calibration check can be initiated without making an entry: press the FUNC key to advance to the desired calibration check. The lower display will show the parameter code (t., rJ., etc.) and the upper display will show “on” or “off.” Press the ▲ or ▼ key to select on or off.

To go to the next parameter without modifying the calibration, press the FUNC key when the displays show “off.” To return to the previous parameter without modifying the calibration, press the MAN key.

To set the parameter calibration, press the FUNC key when the display shows “on.” The display will blank, and only the decimal point of the LSD of the lower display will be lit during the calibration step.

Before beginning calibration, be sure internal switch V101 is open (see “Preliminary Hardware Settings”).

### General Guidelines

- Instrument should be mounted in its case in order to keep internal temperature constant.
- Ambient temperature should be stable. Avoid drift due to air conditioning or other mechanical devices.
- Relative humidity should not exceed 70%.

- Minimum warm up time should be at least 20 minutes.
- Operate as much as possible in a noise free environment.
- During calibration, connect one input at a time to the rear terminal block.
- Before input calibration, the specific settings described in the Preliminary Hardware Settings section must be made.
- Use calibrators with the following:

#### Accuracy

##### Current Input:

- ±0.025% output
- ±0.0025% range
- ±0.01 microamp

##### Voltage Input:

- ±0.005% output
- ±0.001% range
- ±5 microvolt

##### TC Input:

- ±0.005% output
- ±0.001% range
- ±5 microvolt

##### RTD Input:

- ±0.02%
- ±0.0025 ohm/decade

Reference Junction Compensation:  
better than 0.1°C

mA output: better than ±0.1% of the  
readout ±2 microamp

#### Resolution

- Current Input: 0.5 microamp
- Voltage Input: 100 microvolt
- TC Input: 1 microvolt
- RTD Input: 10 milliohm
- Ref. Jct. Compensation: better than 0.1°C
- mA output 1 microamp

## Calibration Parameters

Following is a complete list of calibration symbols:

### CodeParameter

tL	TC/mV Input Minimum Range Value
tH	TC/mV Input Maximum Range Value
t	TC/mV Input Check
rJ	Reference Junction Compensation
rJ.	Reference Junction Compensation Check (in 1/10°C; Reset LED lit)
PL	RTD Input Minimum Range Value
PH	RTD Input Maximum Range Value
P	RTD Input Check
AL	Current Input Minimum Value (0 mA)
AH	Current Input Maximum Value (20 mA)
A.	Current Input Check
nL	5 Volt Input Min. Range Value (0 V)
nH	5 Volt Input Max Range Value (5 V)
n.	5 Volt Input Check
UL	10 Volt Input Minimum Value (0 V)
UH	10 Volt Input Maximum Value (10 V)
U.	10 Volt Input Check

## Procedure

Set the internal DIP switches as explained in the Preliminary Hardware Settings section of this manual. Perform calibration procedures according to the jumper positions, otherwise the stored calibration value might be lost.

Switch on the instrument; the upper display will show "CO nF". Press the ▲ key and the display will show "CAL". Press the "FUNC" key to start the calibration process. Repeatedly press the FUNC key until the desired calibration (parameter) code appears.

Use the ▲ and ▼ keys to select between ON and OFF. To go to the next parameter without modifying the calibration, press the FUNC key when the display shows "OFF".

tL TC/mV input minimum range value

- Perform the preliminary hardware settings. Connect the calibrator and instrument as shown below.

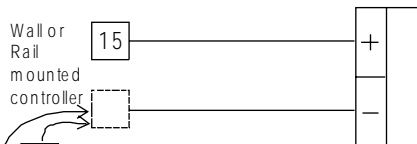
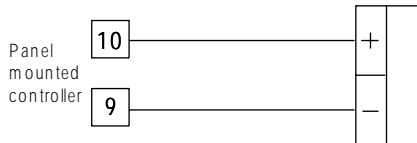

14 for Types G, D, C, B, R, S

11 for Types J, K, L, N, T, E, U, Platinel

- The displays show "OFF" and "tL".
- Set calibrator to 0.000 mV.
- Press the ▲ key; display changes to "ON".
- After a few seconds, start calibration by pressing the FUNC key. The decimal point of the least significant digit will light to indicate the instrument is performing the calibration. When calibration is complete, the instrument will proceed to the next parameter.

tH TC/mV input maximum range value

- Set the calibrator to 60.000 mV.
- Press the ▲ key; the displays will show "ON" and "tH".
- After a few seconds, start calibration by pressing the FUNC key. The decimal point of the least significant digit will light to indicate the instrument is performing the calibration. When this calibration is complete, the instrument will proceed to the next parameter.

t. TC/mV input check

The display will show "t." followed by a number showing the measured value in counts.

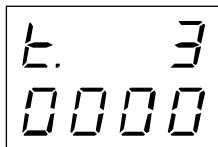

Check the linear calibration by setting:

- 0.000 mV; the readout must be equal to "t.0 0000" ±10 counts.
- 60.000 mV; the readout must be equal to "t.3 0000" ±10 counts.
- 30.000 mV; the readout must be equal to "t.1 5000" ±10 counts.
- Press the FUNC key; go to the next parameter.

rJ Reference junction compensation

Note: Make sure tL and tH are correctly calibrated before attempting rJ calibration.

- Measure the temperature close to terminals 9 and 10 using an appropriate instrument, as shown below.

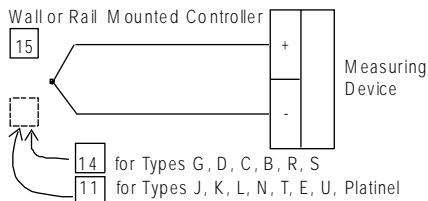
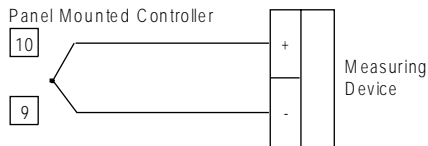

- Wait a few minutes to allow temperature stabilization of the entire system (compensation cable, sensor, calibrator and instrument).
- The displays will show "rJ" and "OFF." Use the ▲ and ▼ keys to make the readout value equal to the temperature measured by the measuring device in tenths of degree Celsius.
- After a few seconds, start calibration by pressing the FUNC key. The decimal point of the least significant digit will light to indicate the instrument is performing the

calibration. When this calibration is complete, the instrument will proceed to the next parameter.

- r.J. Reference junction compensation check  
The display will show "r.J." and the temperature in tenths of °C. Check that the display readout is equal to the value read by the measuring device.

Press the FUNC key; the instrument will proceed to the next parameter.

- PL RTD input minimum range value  
a) Perform the preliminary hardware settings. Connect the calibrator and instrument as shown below.

Panel Mounted Controller

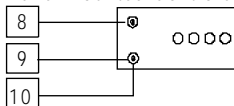

Wall or Rail Mounted Controller

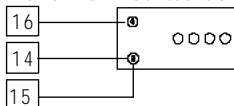

- b) Set 0.00 ohms on the resistor box.  
c) Press the ▲ key; the displays show "ON" and "PL".  
d) After a few seconds, start calibration by pressing the FUNC key. The decimal point

of the least significant digit will light to indicate the instrument is performing the calibration. When this calibration is complete, the instrument will proceed to the next parameter.

- PH RTD input maximum range value  
a) Set resistor box to 375.00 ohms.  
b) Press the ▲ key; the displays will show "ON" and "PH".  
c) After a few seconds, start calibration by pressing the FUNC key. The decimal point of the least significant digit will light to indicate the instrument is performing the calibration. When this calibration is complete, the instrument will proceed to the next parameter.

- P. RTD input check  
The display shows "P." followed by a number showing the measured value in counts.

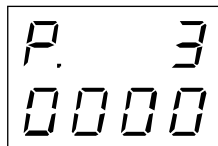

Check the calibration (not linear) by setting the resistance box to:

- a) 0.00 ohms; the readout should be "P. 0 0000" ±10 counts.  
b) 125.00 ohms; the readout should be "P.1 0190" ±10 counts.  
c) 250.00 ohms; readout should be "P. 2 0189" ±10 counts.



- d) 375.00 ohms; readout should be "P. 3 0000"  $\pm 10$  counts.
- e) Press the FUNC key and proceed to next parameter.

#### AL Current input (mA) minimum range value

- a) Perform the preliminary hardware settings. Connect the calibrator and instrument as shown:

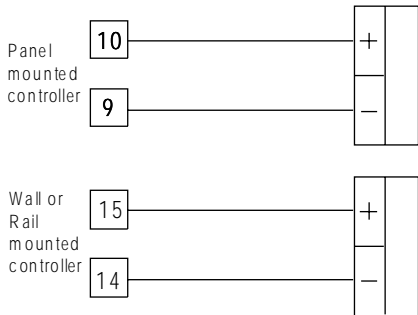

- b) Set 0.000 mA on the calibrator (even if the minimum range value is 4 mA). The upper display shows "OFF."
- c) Press the ▲ key, the display will switch to "ON".
- d) After a few seconds, start calibration by pressing the FUNC key. The decimal point of the least significant digit will light to indicate the instrument is performing the calibration. When this calibration is complete, the instrument will proceed to the next parameter.

#### AH Current input (mA) maximum range value

- a) Set 20 mA on the calibrator.
- b) Press the ▲ key, the displays will show "AH" and "ON".
- c) After a few seconds, start calibration by pressing the FUNC key. The decimal point of the least significant digit will light to indicate the instrument is performing the calibration. When this calibration is complete, the instrument will proceed to the next parameter.

#### A. Current input (mA) check

The display will show "A." followed by a number showing the measured value in counts.

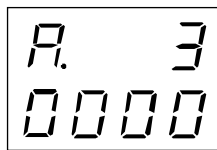

Check the linear calibration by setting the calibrator to:

- a) 0.000 mA; the readout should be "A. 0 0000"  $\pm 10$  counts.
- b) 20.000 mA; readout should be "A. 3 0000"  $\pm 10$  counts.
- c) 10.000 mA; readout should be "A. 1 5000"  $\pm 10$  counts.
- d) Press the FUNC key.

#### nL 5 volt input-minimum range value

- a) Perform the preliminary hardware settings.

Connect the calibrator and instrument as shown:

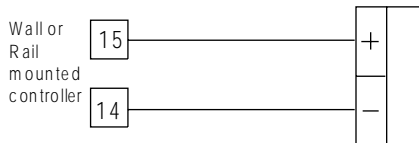
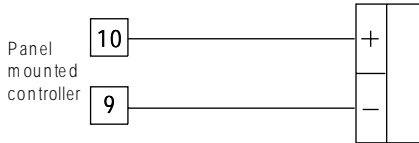

- b) Set 0.000 V on the calibrator (even if the minimum range value is 1 V). The upper display will show "OFF."
- c) Press the ▲ key, the display will show "nL" and "ON."
- d) After a few seconds, start calibration by pressing the FUNC key. The decimal point of the least significant digit will light to indicate the instrument is performing the calibration. When this calibration is complete, the instrument will proceed to the next parameter.

#### nH 5 volt input-maximum range value

- a) Set 5.000 V on the calibrator.
- b) Press the ▲ key, the display will show "nH" and "ON".
- c) After a few seconds, start calibration by pressing the FUNC key. The decimal point of the least significant digit will light to indicate the instrument is performing the calibration. When this calibration is complete, the instrument will proceed to the next parameter

#### n. 5 volt input check

The display will show "n." followed by a number showing the measured value in counts.

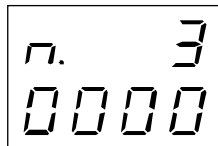

Check the calibration by setting the calibrator to:

- a) 0.000 V; the readout should be "n. 0 0000"  $\pm 10$  counts.
- b) 5.000 V; readout should be "n. 3 0000"  $\pm 10$  counts.
- c) 2.500 V; readout should be "n. 1 5000"  $\pm 10$  counts.
- d) Press the FUNC key to proceed to next parameter.

#### UL 10 volt input - minimum range value

- a) Perform preliminary hardware settings as described in the Configuration section. Connect the instrument to the calibrator as shown:

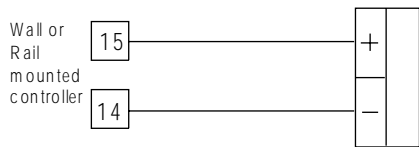
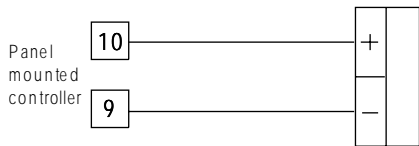

- b) Set 0.000 V on the calibrator (even if the minimum range value is 2 V). The upper display will show "OFF".
- c) Press the ▲ key to enable calibration. The upper display will switch to "ON".
- d) Wait a few seconds until the measurement has stabilized, then push the FUNC key. When calibration is complete, the instrument will go to the next parameter.

#### UH 10 volt input-maximum range value

- a) Set 10.000 V on the calibrator.
- b) Press the ▲ key, the display will show "UH" and "ON".
- c) After a few seconds, start calibration by pressing the FUNC key. The decimal point of the least significant digit will light to indicate the instrument is performing the calibration. When this calibration is complete, the instrument will proceed to the next parameter

#### U. 10 volt input check

The display will show "U." followed by a number showing the measured value in counts.

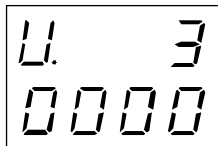

Check the calibration (linear) by setting the calibrator to:

- a) 0.000 V; the readout should be "U.0 0000"  $\pm 10$  counts.
- b) 10.000 V; readout should be "U.3 0000"  $\pm 10$  counts.
- c) 5.000 V; readout should be "U.1 5000"  $\pm 10$  counts.
- d) Press the FUNC key.

This completes the calibration procedure. To enter the configuration procedure press the ▲ key, the display will show "CnF". If configuration and calibration are complete, switch the instrument off and set the DIP switches according the Preliminary Hardware Settings.

## Maintenance

- 1) REMOVE POWER FROM THE POWER SUPPLY TERMINALS AND FROM RELAY OUTPUT TERMINALS
- 2) Remove the instrument from case.
- 3) Using a vacuum cleaner or a compressed air jet (max. 3 kg/cm<sup>2</sup>) remove all deposit of dust and dirt which may be present on the louvers and on the internal circuits trying to be careful for not damage the electronic components.
- 4) To clean external plastic or rubber parts use only a cloth moistened with:
  - Ethyl Alcohol (pure or denatured) [C<sub>2</sub>H<sub>5</sub>OH] or
  - Isopropil Alcohol (pure or denatured) [(CH<sub>3</sub>)<sub>2</sub>CHOH] or
  - Water (H<sub>2</sub>O)
- 5) Verify that there are no loose terminals.
- 6) Before re-inserting the instrument in its case, be sure that it is perfectly dry.
- 7) re-insert the instrument and turn it ON.

## APPENDIX A

### Default parameters

#### Loading Default Operating Parameters

The control parameters can be loaded with predetermined default values. These are the settings loaded into the instrument prior to shipment from the factory. To load the default values proceed as follows:

- a) Press and hold the ▼ key and press the ▲ key; the displays will show:

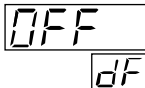

- b) Press either the ▼ or ▲ key; the display will show:

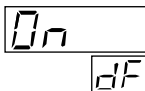

- c) Press the "FUNC" key; the display will show:



This indicates that the loading procedure has been initiated. After about 3 seconds the loading procedure is complete and the instrument reverts to the "Normal Display Mode." The following is a list of the default operating parameters loaded during the procedure:

Default Operating Parameter	Parameters List Default Value
Alarm Acknowledge	OFF
Software Key	Unlock
Setpoint Threshold	Low range value (if low limit) High range value (if high or high/low limit)
Setpoint1 Threshold	Low range value
Setpoint Threshold Hysteresis	0.1%
Alarm Threshold	Low range (if process alarm) 100 (if deviation or band alarm)
Alarm Hysteresis	0.1%

#### Loading Default Configuration Parameters

The configuration parameters can be loaded with predetermined default values. These are the settings loaded into the instrument prior to shipment from the factory. To load the default values proceed as follows:

- a) Internal switch V101 must be open.  
b) The upper display will show:

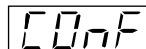

- c) Press the ▼ key; the lower display will show the firmware version.

CONF  
RD

- d) Still holding the ▼ key, press the ▲ key; the display will show:

OFF  
dF

- e) Press the ▲ key to select Table 1 (European) or Table 2 (American) default parameters; the display will show:

tbl2  
dF

- f) Press the FUNC key; the display will show:

LOAD

This indicates that the loading procedure has been initiated. After about 3 seconds the procedure is complete and the instrument reverts to the "CONF" display. The following is a list of the default configuration parameters loaded during the procedure:

PARA.	Table 1	Table 2
	European	American
L1	nbUS	nbus
L2	1	1
L3	19200	19200
L4	8E	8E
r1	Type J (-100 to 1000 °C)	Type J (-150 to 1830 °F)
r2	----	----
r3	-100	-150
r4	1000	1830
r5	0	0
r6	1 second	1 second
r7	uP	uP
c1	Hi	Hi
c2	1	0
c3	Auto	Auto
c4	0	0
c5	1 second	1 second
P1	nonE	nonE
P2	H.A.	H.A.Ac
P3	rEV	rEV
P4	OFF	OFF
PF	1 second	1 second
n1	0	0
t1	10 seconds	30 seconds

## APPENDIX B

### Thermocouple Compensating Cable Color Codes.

Thermocouple Material	British BS 1843	American ANSI MC 96.1	German DIN 43710	French NFE 18-001
T Copper Constantan	+ White - Blue Blue	+ Blue - Red Blue	+ Red - Brown Brown	+ Yellow - Blue Blue
J/L Iron Constantan	+ Yellow - Blue Black	+ White - Red Black	+ Red - Blue Blue	+ Yellow - Black Black
K Nickel Chromium Nickel Aluminum	+ Brown - Blue Red	+ Yellow - Red Yellow	+ Red - Green Green	+ Yellow - Purple Yellow
R Platinum/Platinum 13% Rhodium	+ White - Blue Green	+ Black - Red Green	+ Red - White White	+ White - Green Green
S Platinum/Platinum 10% Rhodium	+ White - Blue Green	+ Black - Red Green	+ Red - White White	+ White - Green Green
E Chromel Constantan	+ Brown - Blue Brown	+ Violet - Red Violet	- -	- -
B Platinum 30% Rh Platinum 6% Rh	- - -	+ Grey - Red Grey	- - -	- - -
N Nicrosil / Nisil		-	-	-



**Eurotherm/Barber-Colman**

741-F Miller Drive  
Leesburg, VA 20175

Telephone: +1 703 443 0000

Facsimile: +1 703 669 1300

Email: [info@eurotherm.com](mailto:info@eurotherm.com)

*Copyright © 1998 Barber-Colman Company.*